

Grinders

Contents	Page
Introduction.....	195
Guide.....	196
Product safety.....	197
Turbine grinders and sanders.....	198
Die grinders.....	202
Straight grinders.....	204
Vertical grinders.....	208
Vertical sanders.....	210
Angle grinders.....	212
Angle sanders.....	214
Orbital and random orbital sanders.....	216
Dust extraction.....	218
Routers.....	221
Circular cutters.....	222



Maximum material removal with minimum effort

Atlas Copco GTG21 and GTG40 Turbine Grinders give you twice the power with half the weight and are impossible to stall with the right installation! Atlas Copco's range covers all, you can rely on maximum material removal with minimum effort.

Die grinding

Small precision deburring – die grinding is performed with either tungsten carbide, high speed steel burrs or mounted points.

The choice of burr depends on the size of your job. A larger volume of removed material will require a bigger size of the burr's head.

Select the tool r/min depending on the diameter of the burr head, the material to be ground and the material in the rotary burr. Use tungsten carbide burrs for hard and tough materials. High speed steel burrs are recommended for unhardened and medium hard materials. Example, see table below:

Burr head Ø		Unhardened steel		Soft material
		Hardened steel Tough materials	Softer materials Cast iron	Wood, brass Plastics, Al.
Up to 6 mm	– TC	38000	38000	38000
	– HSS	–	20000	20000
Up to 12 mm	– TC	30000	30000	30000
	– HSS	–	–	20000

TC – Tungsten carbide tipped rotary burr. HSS – High speed steel burrs.

For mounted points, follow the recommendations that relate to the particular mounted point.

Rough grinding

Pure material removal is determined by the power generated at the grinding process. The applied feed force and the rotation of the wheel generates a cutting force which, multiplied by the peripheral speed of the wheel, represents the power of removed material. (Power=Peripheral speed x Cutting force).

A powerful grinder will provide enough power with maintained rotational speed, when applying feed-force. A suitable combination of operative rotational speed, feed-force applied by the operator and power of the grinder, will give you the best combination for the material removal required.

As rough grinding is performed with bonded abrasives, a limitation of rotational speed is necessary in order to prevent wheel fractures due to centrifugal force.

The peripheral speed is limited to 80 m/s for fibre reinforced depressed center, straight and cutting off wheels. Resin bonded cup and straight wheels are limited to a peripheral speed of 50 m/s.

Sanding and polishing

Unlike die and rough grinding, sanding and polishing applies to requirements of a surface. A fine surface will require a fine grit paper, fine Scotch-Brite, Bear Tex or a soft polishing bonnet. Rougher surface grinding will require a higher material removal rate and thus a coarser grit paper.

Similar to rough grinding, a rough surface, ground with coarse grit will benefit from a high rotational speed. The limitations are, however, the maximum allowed speed of the backing pad and the fibre disc.

Normal sanding speeds for fibre discs of diameter 125 mm, 180 mm and 230 mm are 4000 to 6000 r/min.

Polishing with different pastes and compounds requires low speed in combination with high torque. Suitable speeds are 1800 to 2200 r/min.

Sanding with wet coated abrasives is best performed at low speeds, partly because water is thrown out into the periphery and partly because of the fine grit.

Scotch-Brite, Bear Tex and flap wheels perform best at 50% of their maximum allowed rotational speeds.

The speed governor

The amount of material removed in the grinding process depends on the power of the tool and the operative rotational speed. The diagram below shows the correlation between torque, power and rotational speed of a non governed pneumatic grinder.

In order to remove material, the operator has to apply a feed-force on the work-piece. Consequently the rotational speed decreases and having passed approximately 50% of the free speed, the operative power outtake starts to decrease. Theoretically, the most material would be removed at approximately 50% of the free speed on a non governed grinder, (diagram 1).

Atlas Copco grinders are compact and smooth running, partly due to their speed governor. The air is governed to the air flow necessary to maintain the rotational speed regardless of load (to the extent of the power of the grinder).

The correlation between power, torque and rotational speed of a governed grinder is shown in diagram 2.

A theoretical optimum of material removal is reached at approximately 80% of the free speed. The grinder generates maximum power, removing more material with applied feed force. The rotational speed decreases negligibly.

Air is used economically, as the flow through the motor is adjusted after applied load. Air consumption at free speed is minimized. The governor opens and lets in more air during load thus keeping the optimal r/min.

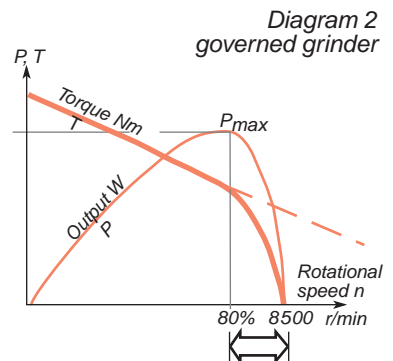
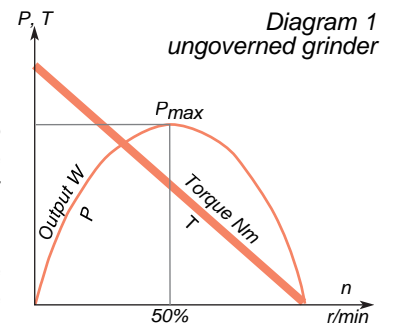

Guides

Die grinding and deburring with die grinders, see page 202

1 Carbide burrs

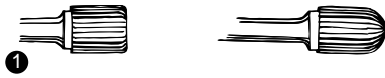

2 Mounted points



Rough grinding and cutting off with rough grinders, see page 198, 204, 208 and 212

3 Depressed center wheels



4 Cut off wheels



5 Cup wheels

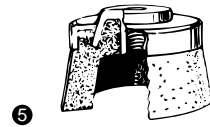

6 Flap wheels



7 Straight wheels

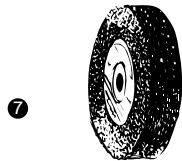

8 Cone wheels

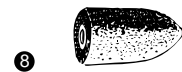

Sanding and polishing with sanders and polishers see page 210, 214 and 216

9 Fibre discs

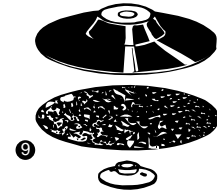

10 Wire brushes

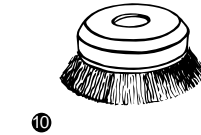

11 Coated abrasives

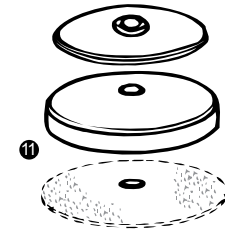

12 Polishing bonnets

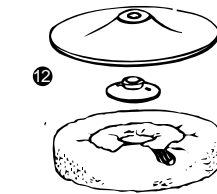

13 Radial flap wheels

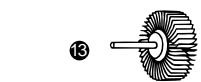

14 Scotch-Brite



Diameter – peripheral speed – r/min

The table below will help you to translate the peripheral speed of the grinding wheel to the correct rotational speed of the grinder when using a grinding wheel with a specific diameter.

Grinding wheel dia mm	Peripheral speed in meters per second													
	10	15	20	25	28	30	33	35	40	45	48	50	60	80
25	7640	11460	15280	19100	21390	22920	25210	26740	30560	34380	36670	38200	45840	61120
40	4770	7160	9550	11930	13370	14320	15750	16710	19100	21480	22920	23870	28650	38200
50	3820	5730	7640	9550	10690	11460	12600	13370	15280	17190	18330	19100	22920	30560
63	3303	4540	6060	7560	8480	9090	10000	10610	12120	13640	14550	15150	18190	24250
80	2380	3580	4770	5960	6680	7160	7870	8350	9550	10740	11460	11930	14320	19100
100	1910	2860	3820	4770	5340	5730	6300	6680	7640	8590	9160	9550	11460	15280
115	1660	2490	3320	4150	4650	4980	5480	5810	6640	7470	7970	8300	9960	13400
125	1520	2290	3050	3820	4270	4580	5040	5340	6110	6870	7330	7640	9160	12280
150	1270	1910	2540	3180	3560	3820	4200	4450	5090	5730	6110	6360	7640	10180
180	1060	1590	2120	2650	2970	3180	3500	3710	4240	4770	5090	5300	6360	8480
200	950	1430	1910	2380	2670	2860	3150	3340	3820	4290	4580	4770	5730	7640
230	830	1240	1660	2070	2320	2490	2740	2900	3320	3730	3980	4150	4980	6640
250	760	1140	1520	1910	2130	2290	2520	2670	3050	3430	3660	3820	4580	6110
300	630	950	1270	1590	1780	1910	2100	2220	2540	2860	3050	3180	3820	5090

This is your responsibility

Always read and understand the safety information supplied with the tool and on www.atlascopco.com. All locally legislated safety rules regarding installation, operation and maintenance shall be respected at all times.

1. Check the free speed

- The measured speed at a pressure of 6.3 bars must not exceed the rated speed, which is marked on the grinder.
- Remove the grinding wheel and outer flange before checking the free speed.
- Carry out checks daily.
- Make sure the speed marking on the tool is legible.
- Return the machine for repair in the event of overspeeding.



2. Check the wheel guard

The wheel guard protects your health and safety.

- Always use the recommended wheel guard.
- Check that it is not damaged.
- Never use a grinder without the wheel guard.
- Position the wheel guard between yourself and the grinding wheel.



Check that the trigger is working correctly.

- The trigger must never be removed or fixed by tape for example.
- If the trigger is not working properly, make sure that it is replaced.

3. Maximum speed

Make sure that the stated maximum speed of the grinding wheel is greater than or equal to the speed specified on the grinder.

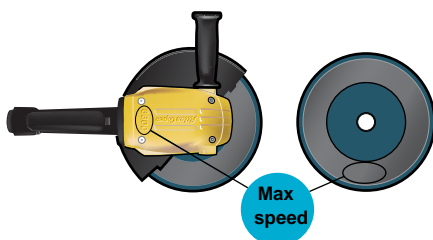

4. Check the grinding wheel

Make sure that the grinding wheel is not cracked or damaged in any way.

- The grinding wheel should have the correct hole dimensions and be fitted correctly on the spindle to avoid unbalanced vibrations.
- Damaged grinding wheels must be removed and replaced immediately.
- Do not use dropped or damaged wheels, as these can cause serious injuries.

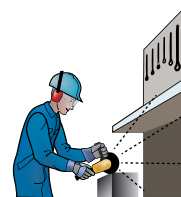
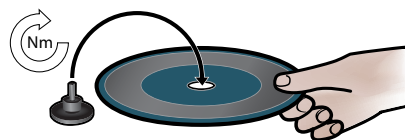

5. Check the flange and wheel

Make sure that flange and wheel combinations correspond to national regulations.

- Check that the flanges are undamaged and clean.
- Attach the wheel with the recommended torque.
- Always disconnect the air-supply when changing the wheel or adjusting the tool.
- Test-run your grinder in a protected area after assembling the wheel.
- Check that the grinder is working correctly.

6. Personal protection equipment

Make sure that operators wear:

- Eye protection, goggles or a visor.
- Ear protection.
- Gloves.
- Steel toe-capped shoes.
- Protective clothing, such as a leather apron.
- A helmet (for heavier applications).
- Avoid loosely hanging clothing, hair, jewellery (risk of getting caught).



7. Working area

Ensure that the area in which you are working is kept free from other people so that no one can get injured.

- People nearby must also wear hearing and eye protection.
- Check that there is good ventilation and dust extraction from the premises.
- There should be a stand or a place available, on which the machine can be safely placed.
- Work within a sealed-off area, if possible with protecting walls, since there is a risk that broken discs could fly off.

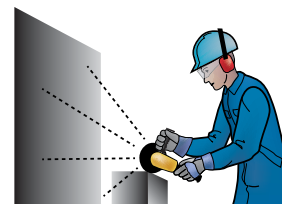

During work

Stop using the grinder if abnormally loud noises and vibrations occur during use. The grinder and its accessories must not be modified in any way.

After the work is finished

Make sure the machine is switched off and has come to a complete stop before it is put down. Put down the tool carefully, so that there is no risk of the tool starting by itself.



Maintenance

Make sure you follow the service instructions provided and the recommended service intervals. Do not dismantle safety-related parts such as the speed governor and overspeed shut off. These parts should be completely replaced when damaged.

Twice the power. Half the weight. The GTG21 gives you twice the power of today's 5", 7" and 9" angle grinders. It is about half the size and weight of high frequency tools with comparable power.

- High material removal – The turbine is powerful and keeps on working at high rotational speed. It gives a higher rate of cutting-off or material removal, with low wheel consumption.
- Power for efficiency – GTG21 is driven by a turbine motor, providing power-to-weight ratios never before achieved in grinders. This means you can choose a lighter, more compact tool for ease of use and good accessibility without sacrificing any of the power.
- Long service life – The turbine means there are no vanes to slide against the cylinder. The gear runs in oil in a housing with patented seals. The result is consistent performance and uninterrupted free operation.
- Ergonomics – Our ergonomic design of the handle gives you a more comfortable grip, increases productivity and decreases the risk for musculoskeletal disorders. Our vibration dampening technique, Auto balancer, is used to counterbalance the imbalance in the wheel and minimize vibrations.
- Low power-to-weight in combination with low height-over-spindle also gives you better accessibility and less strain when working in cramped spaces.
- Lubrication-free – The unique turbine means that the motor doesn't need oil in the air for lubrication. This provides several benefits in terms of working environment, quality and productivity.
- Dust extraction – Efficient accessory for extraction of air-borne dust in sanding applications with fiber discs.

GTG21 is the latest of the turbine grinders. It is the best choice for rough grinding and sanding applications.

GTG21 F120-13



GTG21 F085-18



GTG21 S085



GTG21 S085 equipped with spot suction kit

MORE EFFECTIVE

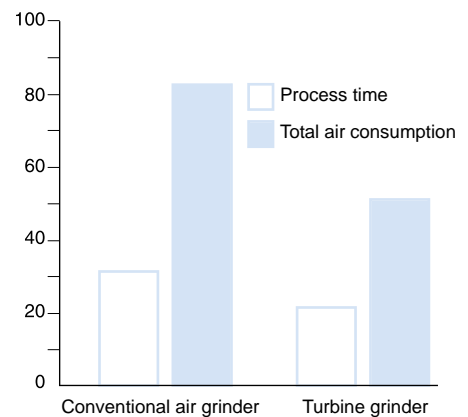

The turbine motor is more efficient than a conventional grinder motor. Therefore it takes less time to do the same job. Also the total air consumption will be a lot less for a specific job.

Model	Max free speed r/min	For wheel dia mm	Max output		Weight		Height over spindle		Air consumption at max output				Rec. hose size		Air inlet thread BSP	Ordering No.
			kW	hp	kg	lb	mm	in	l/s	cfm	l/s	cfm	mm	in		
For grinding and cutting off																
GTG21 F120-13	12000	125	2.1	2.8	1.8	3.9	68	2.7	30	64	10	21	13	1/2	3/8	8423 2963 00
GTG21 F085-18	8500	180	2.1	2.8	2.0	4.2	72	2.8	30	64	10	21	13	1/2	3/8	8423 2963 02
For sanding																
GTG21 S085 ^a	8500	180	2.1	2.8	1.6	3.5	80	3.1	30	64	10	21	13	1/2	3/8	8423 2963 05
GTG21 S085 M14	8500	180	2.1	2.8	1.6	3.5	80	3.1	30	64	10	21	13	1/2	3/8	8423 2963 07
GTG21 D120 ^{ab}	12000	125	2.1	2.8	1.6	3.5	92	3.6	30	64	10	21	13	1/2	3/8	8423 0800 00
GTG21 D085 ^b	8500	180	2.1	2.8	1.6	3.5	92	3.6	30	64	10	21	13	1/2	3/8	8423 0800 01

^a UNC 5/8"-11 spindle.

Flow requirement 250 m³/h.

^b Models prepared for use with spot suction kit which must be ordered separately.

Accessories Included

All models

Adjustable support handle
Whip hose 0.7 m long, 13 mm dia complete with nipple and ErgoNIP 10
Gearbox oil, one tube

① GTG21 F120/F085

Adjustable wheel guard
Attachment flanges for 1-10 mm thick grinding wheels
Hex key for wheel change

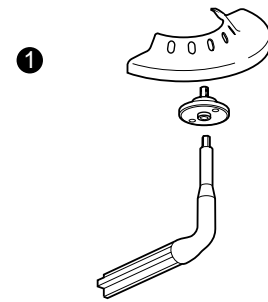

Optional Accessories

Air hose set for maximum performance	Ordering No.
RUBAIR 13, L=5 m, included ErgoNIP 10, ErgoQIC 10	8202 1180 22
Air preparation unit, incl MIDI F/R, ball valve ErgoQIC 10	8202 0845 48
TURBO 16, L=10 m, included ErgoNIP 10, ErgoQIC 10	8202 1180 46

Spot suction kit for GTG21 D120 and GTG21 D085

Model	Ordering No.	
	Dia 125 mm	Dia 180 mm
Grinding with depressed center wheel		
GTG21 D120	3780 4090 23	
GTG21 D085		3780 4090 21
Sanding with fiber disc		
GTG21 D120	3780 4090 24	
GTG21 D085	3780 4090 24	3780 4090 26
Cutting GRP with diamond disc		
GTG21 D120	3780 4090 25	
GTG21 D085		3780 4090 22
Diamond disc	3780 5074 61	3780 5074 62

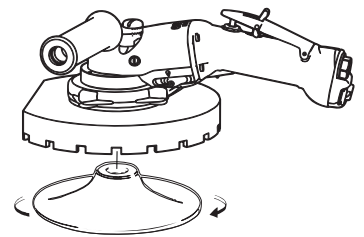

Spot suction kit (ex. sanding with fiber disc)

Spindle adapter kit for sanding

Sanding kit for	Support pad dia mm	Ordering No.	
		5/8"	M14
GTG21 F120-13	120	4175 0883 92	4175 0883 93
GTG21 F085-18	162	4175 0883 90	4175 0883 91
Adapter ^a		4175 0883 04	4175 0883 03
Nut ^a		4175 0893 00	4175 0893 02

^a Included in the kit.

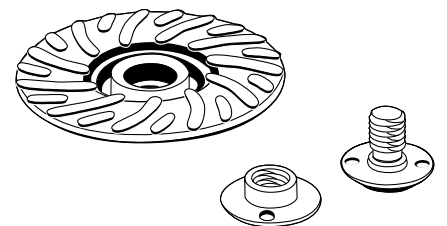

Spindle adapter kit

Productivity Kits

Model	Air inlet BSP	Max air flow	Hose, 5 m	Coupling	Lubrication	Ordering No.
MIDI Optimizer F/R EQ10-T13	1/2	35 l/s	Turbo 13 mm	ErgoQIC 10	No	8202 0850 04
MAXI F/R C-T16	1/2	60 l/s	Turbo 16 mm	Claw	No	8202 0850 05
MAXI F/RD C-T20	1/2	65 l/s	Turbo 20 mm	Claw	No	8202 0850 20



Service Kits

4081 0220 90

The GTG/GTR40 are the most powerful grinders in the turbine grinder range, with incredible power for their size and weight. The range includes angle and straight type grinders for virtually every common rough grinding application.

- GTG40 F – for rough grinding and cutting off with depressed center wheels.
- GTG40 S – for surface finishing with fibre discs and wire brushes.
- GTG40 C – for rough grinding with cup wheels.
- GTR40 – for rough grinding and applications such as internal and external cleaning of castings with straight grinding wheels.
- Dust extraction – Efficient accessory for extraction of air-borne dust in sanding applications with fiber discs.



MORE EFFECTIVE

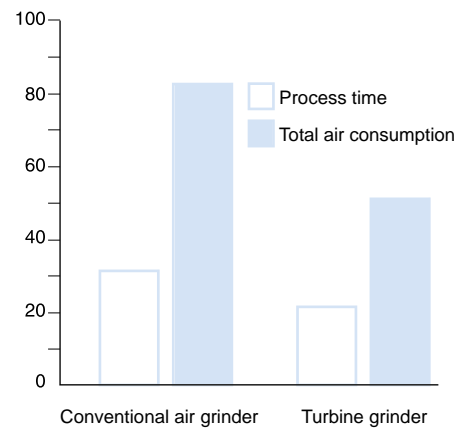

The turbine motor is more efficient than a conventional grinder motor. Therefore it takes less time to do the same job. Also the total air consumption will be a lot less for a specific job.

Model	Max free speed r/min	For wheel dia mm	Max output		Weight		Height over spindle		Air consumption at				Rec. hose size		Air inlet thread BSP	Ordering No.
			kW	hp	kg	lb	mm	in	max output l/s	free speed cfm	l/s	cfm	mm	in		
For grinding and cutting off																
GTG40 F085-18	8500	180	4.5	6.1	3.8	8.4	128	5.0	60	126	20	42	16	5/8	1/2	8423 2900 10
GTG40 F066-23	6600	230	4.5	6.1	4.0	8.8	128	5.0	60	126	20	42	16	5/8	1/2	8423 2910 10
For sanding with fibre disc and wire brush																
GTG40 S060	6000	140 ^a	4.5	6.1	3.6	7.9	132	5.2	60	126	20	42	16	5/8	1/2	8423 2930 00
For cup wheel type 11																
GTG40 S060-C15 ^b	6000	150	4.5	6.1	4.3	10.5	126	5.0	60	126	20	42	16	5/8	1/2	8423 2930 10

^a For wire brush, Ø 230 mm for fibre disc. ^b Spindle thread: UNC 5/8". Length 23.5 mm.

Model	Max free speed r/min	For wheel dia DxTxH ^a mm	Spindle thread	Max output		Weight		Length mm	Air consumption at				Rec. hose size		Air inlet thread BSP	Ordering No.
				kW	hp	kg	lb		max output l/s	free speed cfm	l/s	cfm	mm	in		
GTR40 S085-15	8500	150x25x25	UNC 5/8-11	4.5	6.1	5.6	12.3	563	60	126	20	42	16	5/8	1/2	8423 2950 00
GTR40 S072-13	7200	125x25x25	UNC 5/8-11	4.5	6.1	5.6	12.3	563	60	126	20	42	16	5/8	1/2	8423 2951 00
GTR40 S060-15	6000	150x25x25	UNC 5/8-11	4.5	6.1	5.8	12.8	563	60	126	20	42	16	5/8	1/2	8423 2952 00
GTR40 S060-20	6000	200x25x25	UNC 5/8-11	4.5	6.1	5.8	12.8	563	60	126	20	42	16	5/8	1/2	8423 2954 00

^a For straight wheels.

Accessories Included

GTG40

- Adjustable wheel guard
- Support handle
- Attachments flanges for 1.5-7 mm thick cut-off wheels and 2.5-8 mm thick depressed center wheels
- Whip hose 0.7 m long, 16 mm dia complete with nipple and ErgoNIP 10
- Gearbox oil, one tube
- Hex key for wheel change

GTR40

- Wheel guard
- Attachments flanges for grinding wheels 20-25 mm thick and with hole Ø 25 mm
- Whip hose 0.7 m long, 16 mm dia complete with nipple and ErgoNIP 10
- Gearbox oil, one tube
- Key and spanner for wheel change

Optional Accessories

GTG40

	Ordering No.
Wire brush Ø 140 mm	4170 0685 00
Wire brush attachment set	4170 0550 82
Heavy duty backing pad for sanding Ø 180 mm (7")	4170 1192 90
Ø 230 mm (9")	4170 1193 90
Hand shield	4175 0165 90
Adapter for positioning support handle 120/135° between handles	4175 0164 90 ^b
Adapter kit fibre disc	4175 0238 90
Dust extraction kit ^a for 180 mm fiber disc GTG40 S060	3780 4090 11
Hose kit including 1.8 m vacuum hose, Ø 38 mm and air hose Ø 13 mm	3780 2724 41
Friction plate complete	4175 0186 90
Attachment for cup wheel with plane hole	4175 0178 90
Modification kit for handle inclined 10°	4170 1157 93

^a Incl flow chamber, suction cap and support pad.
^b Included as standard in GTG40 S060-C15.

GTR40

	Thickness x Hole dia mm	Ordering No.
2 Rear flange	TxH20-25x 16	2a 4150 0619 00
	x 20	2b 4150 1650 00
	x 32	2c 4150 0620 00
3 Spacer for cone wheel		3 4150 0787 00

GTG40

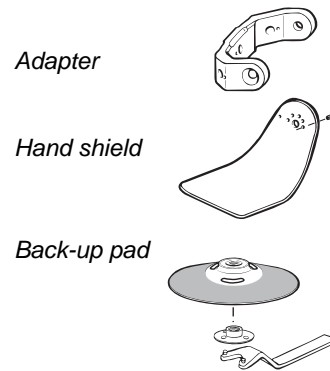

GTR40

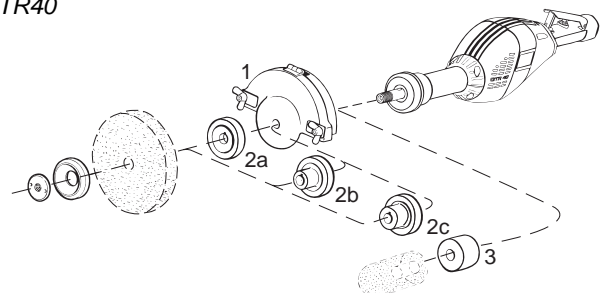

Productivity Kits

Model	Air inlet BSP	Max air flow	Hose, 5 m	Coupling	Lubrication	Ordering No.
MAXI F/R C-T16	1/2	60 l/s	Turbo 16 mm	Claw	No	8202 0850 05
MAXI F/RD C-T20	1/2	65 l/s	Turbo 20 mm	Claw	No	8202 0850 20



Service Kits

GTG40	4081 0153 90
GTR40	4081 0153 91

- LSF07 is a high speed model for precision grinding and polishing. LSF07 is delivered with a 3 mm collet and can be equipped with a 1/8" collet as optional. (Without speed governor)
- LSF12/LSV12 – Small and comfortable die grinder with up to 360 W for maximum control in cramped spaces. All models are delivered with speed governor and a well balanced 6 mm Erickson collet.
- LSF19/LSV19 – All models in the 19 series are equipped with a powerful 0.5 kW air motor and a speed governor. The angled models (LSV) have a patented solution that overcomes temperature and leakage problems commonly associated with angle head tools. The result is a leak free and self-cooled angle head. All models are lubrication free except for the high speed model LSF19 S460.
- LSF28/LSV28 – Powerful 0.85 kW air motor, with speed governor and scatter damping. Impressive power-to-weight ratio.



- LSF38 – One of the most powerful one hand die grinders on the market, up to 1.35 kW. The die grinders in the 38 series are lubrication free with scatter damping for maximum operator comfort and safety.

Model	Max free speed r/min	Rec. max dia of Tungsten Carbide Mounted		Max output		Weight			Air consumption at				Rec. hose size		Air inlet thread BSP	Collet size	Ordering No.
		burrs mm	points mm	kW	hp	kg	lb	mm	l/s	cfm	l/s	cfm	mm	in			
Straight die grinders																	
LSF12 S400-1 ^a	40000	9	16	0.36	0.48	0.4	0.8	170	9.8	20.8	7.0	14.8	8	5/16	1/4	6 mm	8423 1124 04
LSF12 S310-1 ^a	31000	12	20	0.32	0.43	0.4	0.8	170	9.2	19.5	4.2	8.9	8	5/16	1/4	6 mm	8423 1124 03
LSF12 S250-1 ^a	25000	12	20	0.29	0.39	0.4	0.8	170	8.5	18.0	3.4	7.2	8	5/16	1/4	6 mm	8423 1124 02
LSF12 S200-1 ^a	20000	12	20	0.24	0.32	0.4	0.8	170	8.1	17.2	2.6	5.5	8	5/16	1/4	6 mm	8423 1124 01
LSF19 S460E-1/R	46000	9	16	0.51	0.68	0.7	1.5	293	11.4	24.0	15.0	31.5	10	3/8	1/4	6 mm	8423 1224 90
LSF19 S460-1	46000	9	16	0.51	0.68	0.5	1.1	193	11.4	24.0	15.0	31.5	10	3/8	1/4	6 mm	8423 1224 82
LSF19 S460E-1	46000	9	16	0.51	0.68	0.7	1.5	293	11.4	24.0	15.0	31.5	10	3/8	1/4	6 mm	8423 1224 87
LSF19 S300-1	30000	12	20	0.50	0.67	0.5	1.1	193	11.3	23.7	6.6	13.8	10	3/8	1/4	6 mm	8423 1224 81
LSF19 S300-2	30000	12	20	0.50	0.67	0.5	1.1	193	11.3	23.7	6.6	13.8	10	3/8	1/4	1/4 in	8423 1224 84
LSF19 S300-1/R	30000	12	20	0.50	0.67	0.5	1.1	193	11.3	23.7	6.6	13.8	10	3/8	1/4	6 mm	8423 1224 89
LSF19 S300E-1	30000	12	20	0.50	0.67	0.7	1.5	293	11.3	23.7	6.6	13.8	10	3/8	1/4	6 mm	8423 1224 86
LSF19 S300E-1/R	30000	12	20	0.50	0.67	0.7	1.5	293	11.3	23.7	6.6	13.8	10	3/8	1/4	6 mm	8423 1224 88
LSF19 S200-1	20000	12	20	0.50	0.67	0.5	1.1	193	9.6	20.1	3.5	7.4	10	3/8	1/4	6 mm	8423 1224 80
LSF19 S200-2	20000	12	20	0.50	0.67	0.5	1.1	193	9.6	20.1	3.5	7.4	10	3/8	1/4	1/4 in	8423 1224 83
LSF19 S200E-1	20000	12	20	0.50	0.67	0.7	1.5	293	9.6	20.1	3.5	7.4	10	3/8	1/4	6 mm	8423 1224 85
LSF28 S250 ^a	25000	12	32	0.86	1.15	0.8	1.7	213	18.5	39.2	11.0	23.3	10	3/8	3/8	6 mm	8423 1235 11
LSF28 S250E ^a	25000	12	32	0.86	1.15	1.3	2.8	338	18.5	39.2	11.0	23.3	10	3/8	3/8	6 mm	8423 1235 60
LSF28 S250E-R ^a	25000	12	32	0.86	1.15	1.3	2.8	338	18.5	39.2	11.0	23.3	10	3/8	3/8	6 mm	8423 1235 49
LSF28 S250-R ^a	25000	12	32	0.86	1.15	0.8	1.7	213	18.5	39.2	11.0	23.3	10	3/8	3/8	6 mm	8423 1235 48
LSF28 S180	18000	16	40	0.82	1.10	0.8	1.7	213	17.4	36.9	11.0	23.3	10	3/8	3/8	6 mm	8423 1235 04
LSF28 S180E	18000	16	40	0.82	1.10	1.3	2.8	338	17.4	36.9	7.0	14.8	10	3/8	3/8	6 mm	8423 1235 05
LSF28 S180E-1R	18000	16	40	0.82	1.10	1.3	2.8	338	17.4	36.9	7.0	14.8	10	3/8	3/8	6 mm	8423 1235 42
LSF28 S180-1R	18000	16	40	0.82	1.10	0.8	1.7	213	17.4	36.9	7.0	14.8	10	3/8	3/8	6 mm	8423 1235 41
LSF28 S150	15000	16	40	0.70	0.94	0.8	1.7	213	15.0	31.8	5.5	11.7	10	3/8	3/8	6 mm	8423 1235 64
LSF28 S150E	15000	16	40	0.70	0.94	1.3	2.8	338	15.0	31.8	4.3	9.1	10	3/8	3/8	6 mm	8423 1235 61
LSF28 S120	12000	16	40	0.66	0.89	0.8	1.7	213	13.8	29.3	4.0	8.5	10	3/8	3/8	6 mm	8423 1235 67
LSF38 S250E-01 ^a	25000	16	40	1.35	1.80	1.5	3.3	356	28.0	58.0	25.0	53.0	13	1/2	3/8	6 mm	8423 1231 17
LSF38 S180E-01	18000	16	40	1.35	1.80	1.5	3.3	356	28.0	58.0	15.0	31.0	13	1/2	3/8	6 mm	8423 1231 16
LSF38 S180E-01/R	18000	16	40	1.35	1.80	1.5	3.3	356	28.0	58.0	15.0	31.0	13	1/2	3/8	6 mm	8423 1231 15
LSF38 S150E-01/R	15000	16	40	1.25	1.70	1.5	3.3	356	24.0	50.0	13.0	27.0	13	1/2	3/8	6 mm	8423 1231 14
Angle die grinders																	
LSV12 S200-1 ^a	20000	12	20	0.29	0.39	0.5	1.2	166	9.5	20.1	6.4	13.6	8	5/16	1/4	6 mm	8423 1124 06
LSV12 S120-1 ^a	12000	12	20	0.24	0.33	0.5	1.2	166	8.3	17.6	3.0	6.4	8	5/16	1/4	6 mm	8423 1124 05
LSV19 S200-1	20000	12	20	0.46	0.62	0.6	1.3	185	11.3	23.9	7.5	15.9	10	3/8	1/4	6 mm	8423 0111 41
LSV19 S120-1	12000	12	20	0.46	0.62	0.6	1.3	185	11.3	23.9	7.5	15.9	10	3/8	1/4	6 mm	8423 0111 43
LSV19 S080-1	8000	12	20	0.37	0.50	0.6	1.3	185	11.3	23.9	6.5	13.8	10	3/8	1/4	6 mm	8423 0111 46
LSV28 S150	15000	16	40	0.68	0.91	1.2	2.5	250	17.0	36.0	8.3	17.6	10	3/8	3/8	6 mm	8423 0125 54

^a Not lubrication-free. ^b 3 mm collet -1 = 6 mm collet -2 = 1/4 collet E = Extended version R = Model is rigid, without scatter damping

Model	Max free speed r/min	Rec. max dia of		Max output		Weight		Length mm	Air consumption at				Rec. hose size		Air inlet thread	Collet size	Ordering No.
		Tungsten carbide burrs mm	Mount-ed points mm	kW	hp	kg	lb		max output l/s	free speed cfm	l/s	cfm	mm	in			
Grinders for polishing																	
LSF28 ST030	3000	—	—	0.67	0.90	1.2	2.6	257	18.0	38.2	8.6	18.2	10	3/8	3/8	6 mm	8423 1235 63
LSF28 ST030E	3000	—	—	0.67	0.90	1.8	3.9	383	18.0	38.2	8.6	18.2	10	3/8	3/8	6 mm	8423 1235 62
LSF28 ST070 ^a	7000	—	—	0.76	1.02	1.2	2.6	257	18.9	40.1	12.4	23.6	10	3/8	3/8	6 mm	8423 1235 66
LSF28 ST070E ^a	7000	—	—	0.76	1.02	1.8	3.9	383	18.9	40.1	12.4	23.6	10	3/8	3/8	6 mm	8423 1235 65
High speed pen model																	
LSF07 S850 ^b	88000	4	6	0.10	0.10	0.4	0.9	173	2.2	4.9	2.3	4.6	4.5	3/16	—	3 mm	8423 1222 03

^a Not lubrication-free. ^b 3 mm collet -1 = 6 mm collet -2 = 1/4 collet E = Extended version R = Model is rigid, without scatter damping

Accessories Included

LSF07

Air hose, ErgoNIP 08, Collet 3 mm (See ill 1.)

LSF/LSV12

Spanner, Collet 6 mm (See ill. 7), Air hose, air hose nipple and clamp, Exhaust hose

LSF/LSV19/28

Spanner, Collet 6 mm (See ill 1.), Air hose, air hose nipple and clamp, Exhaust hose

LSF38

Air hose nipple, Collet 6 mm (See ill 1.)

Optional Accessories

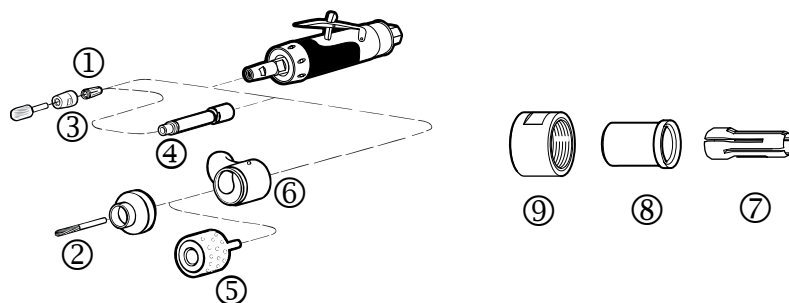

	LSF07	LSF/LSV12	LSF/LSV19	LSF/LSV28	LSF38	See ill.
Optional collets						
Collet 1/8"	4150 1822 00	4150 2226 46	-	-	-	7
Collet 3 mm	-	-	4150 0081 00	4150 0081 00	-	1
Collet 6 mm	-	4150 2226 03	4150 0075 00	4150 0075 00	-	7
Collet 8 mm	-	-	4150 0074 00	4150 0074 00	-	1
Collet 1/4"	-	-	4150 0076 00	4150 0076 00	4150 1754 00	1
Collet 10 mm	-	-	-	-	4150 0681 00	1
Collar	-	4150 2226 02	-	-	-	8
Collet nut	-	4150 2226 04	4150 0760 00	4150 0760 00	4150 0849 00	9
Extension 75 mm/3 in	-	-	4150 0674 00 ^a	4150 0674 00 ^a	-	4
For machining of plastic and glass fibre						
Diamond burr Ø 6 mm	-	3780 5013 70	3780 5013 70	3780 5013 70	-	2
Diamond drum Ø 27 mm	-	-	3780 5033 00	-	-	5
Diamond drum Ø 52 mm	-	-	-	3780 5035 00	-	5
Spot suction kit for burr (burr not included)	-	3780 3015 23	3780 3015 22	3780 4007 42	-	6
Spot suction kit for drum (drum not included)	-	-	3780 4011 61 ^b	3780 4011 73 ^c	-	6

^a Only for rigid (-R) models ^b For use with 6 mm collet ^c For use with 8 mm collet

Productivity Kits

Model	Air inlet BSP	Max air flow	Hose, 5 m	Coupling	Lubrication	Ordering No.
MIDI Optimizer F/RD EQ10-R13-W, incl. whiphose	3/8	23 l/s	Rubair 13 mm	ErgoQIC 10	Yes	8202 0850 14
MIDI Optimizer F/RD EQ10-R13-W, incl. whiphose	—	23 l/s	Rubair 13 mm	ErgoQIC 10	Yes	8202 0850 15
MIDI Optimizer F/RD EQ10-T13	3/8	35 l/s	Turbo 13 mm	ErgoQIC 10	Yes	8202 0850 17
MIDI Optimizer F/R EQ10-T13	1/2	35 l/s	Turbo 13 mm	ErgoQIC 10	No	8202 0850 04
MIDI Optimizer F/RD EQ10-T13	1/2	35 l/s	Turbo 13 mm	ErgoQIC 10	Yes	8202 0850 13
MIDI Optimizer F/RD EQ10-T16	1/2	40 l/s	Turbo 16 mm	ErgoQIC 10	Yes	8202 0850 12
MAXI F/R C-T16	1/2	60 l/s	Turbo 16 mm	Claw	No	8202 0850 05
MAXI F/RD C-T20	1/2	65 l/s	Turbo 20 mm	Claw	No	8202 0850 20



Service Kits

07 series 4081 0243 90 12 series 4081 0472 90 19 series 4081 0486 90 28 series 4081 0315 90 38 series 4081 0308 90

Straight Grinders

For Cone Wheels and Collet

Atlas Copco straight grinders for cone wheel or collet, are suitable for grinding in holes and cavities in castings, etc. They require rough abrasives, which must be attached to the tool with a rigid shank or be mounted directly to the spindle.

The power ranges from 0.7 kW to 2 kW. All Atlas Copco tools are designed with focus on operator ergonomics and maximum power, the best combination for maximum productivity.

- The LSR28 and 38 are suitable for lighter applications where accessibility is first priority.
- LSR43 has a proven and rigid design, and is suitable for those really tough applications where durability is needed.
- If you need maximum power, then LSR48 is the natural choice. You will have access to 2 kW in combination with auto balancer for even less vibrations. All packed in a strong and light package.



Model	Max free speed r/min	Max output		Weight		Length mm	Air consumption at				Rec. hose size		Air inlet thread BSP	Ordering No.
		kW	hp	kg	lb		max output l/s	free speed cfm	l/s	cfm	mm	in		
LSR28 S150-CW	15000	0.70	0.94	1.2	2.6	304	18.0	38.2	5.8	12.3	13	3/8	3/8	8423 1325 06
LSR28 S120-CW	12000	0.66	0.88	1.2	2.6	304	15.8	33.5	4.3	8.6	13	3/8	3/8	8423 1325 05
LSR38 S180-CW	18000	1.35	1.80	1.5	3.3	323	28.0	58.0	15.0	31.0	13	3/8	3/8	8423 1232 30
LSR38 S150-CW	15000	1.25	1.70	1.5	3.3	323	24.0	50.0	13.0	27.0	13	3/8	3/8	8423 1232 31
LSR43 S150-30C ^a	15000	1.0	1.3	2.1	4.6	503	23.0	49.0	10.0	21.0	13	1/2	1/2	8423 1432 33
LSR43 S120-30 ^a	12000	0.9	1.2	2.0	4.4	438	20.0	42.0	7.0	15.0	13	1/2	1/2	8423 1432 24
LSR48 S150-CW	15000	2.0	2.7	2.3	5.0	450	35.0	74.0	19.0	40.0	16	5/8	1/2	8423 1430 08
LSR48 S120-CW	12000	1.8	2.4	2.3	5.0	450	30.0	64.0	13.0	27.0	16	5/8	1/2	8423 1430 05
LSR48 S090-CW	9000	1.5	2.0	2.3	5.0	450	28.0	59.0	11.0	23.0	16	5/8	1/2	8423 1430 03

^a Not lubrication free.

-CW, -30 = Cone wheel model

-30C = With collet

LSR28/38 CW indicates use for cone wheel or collet, thread M12x1 to be combined with adapter for wheel thread. LSR48 has UNC 1/2 spindle for direct attachment of CW. For 5/8 and collet use adapter, see page for accessories.

Accessories Included

LSR28/38 CW

- Air hose nipple and clamp
- Exhaust hose
- Wrenches
- Whip hose (only LSR 28)

LSR43 30/30C

- Hose nipple
- Wrench

LSR48 CW

- Whip hose
- Wrench

Optional Accessories

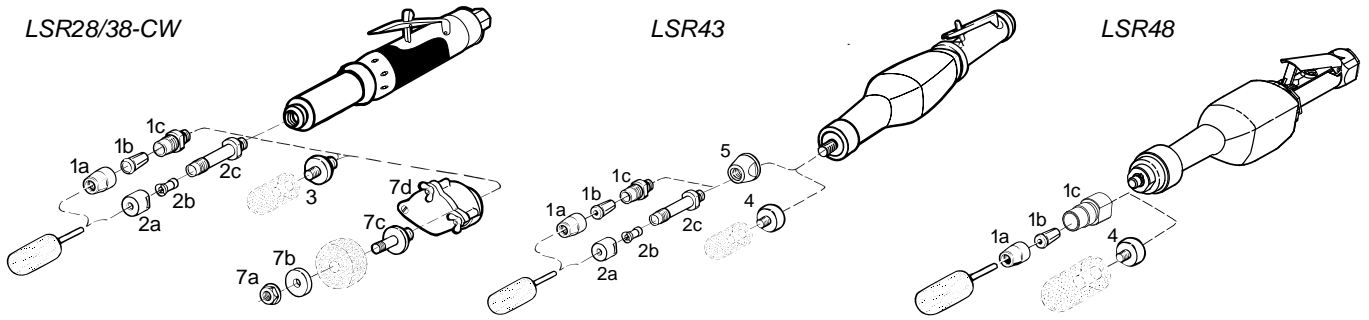

LSR28/38

	See ill.	Ordering No.
Adapter for cone wheel with thread		
UNC/W 3/8"	3	4150 0318 00
UNF 3/8"	3	4150 0318 01
UNC 1/2"	3	4150 1357 00
UNC/W 5/8"	3	4150 0767 00
Collet type 1b		
Nut	1a	4150 0849 00
Collet Ø 6 mm	1b	4150 1453 00
Collet Ø 8 mm	1b	4150 0706 00
Collet Ø 9 mm	1b	4150 0765 00
Collet Ø 10 mm	1b	4150 0681 00
Collet Ø 1/4"	1b	4150 1754 00
Collet holder	1c	4150 0680 00
Collet type 2b		
Nut	2a	4150 0221 00
Collet Ø 6 mm	2b	4150 0222 00
Collet Ø 8 mm	2b	4150 0325 00
Collet Ø 1/4"	2b	4150 0223 00
Collet holder 90 mm	2c	4150 0441 00
Collet holder 45 mm	2c	4150 0211 00
Parts for (50x19x10) wheels		
Nut	7a	0266 2111 00
Flange	7b	4106 5938 00
Holder	7c	4150 0212 00
Wheel guard	7d	4150 1299 81
Parts for (50x13x10) wheels		
Nut	7a	0266 2111 00
Flange	7b	4106 5938 00
Holder	7c	4150 1145 00
Wheel guard	7d	4150 1299 81

LSR43

	See ill.	Ordering No.
Adapter for cone wheel with thread		
UNC/W 3/8"	4	4150 0943 00
UNF 3/8"	4	4150 0943 01
UNC 1/2"	4	4150 0944 00
UNC/W 5/8"	4	4150 0945 00
Collet type 1b		
Nut	1a	4150 0849 00
Collet Ø 6 mm	1b	4150 1453 00
Collet Ø 8 mm	1b	4150 0706 00
Collet Ø 9 mm	1b	4150 0765 00
Collet Ø 10 mm	1b	4150 0681 00
Collet Ø 1/4"	1b	4150 1754 00
Collet holder	1c	4150 0680 00
Collet type 2b		
Nut	2a	4150 0221 00
Collet Ø 6 mm	2b	4150 0222 00
Collet Ø 8 mm	2b	4150 0325 00
Collet Ø 1/4"	2b	4150 0223 00
Collet holder 90 mm	2c	4150 0441 00
Adapter to mount 1c and 2c	5	4150 0861 00

LSR48

	See ill.	Ordering No.
Adapter for cone wheel with thread		
UNC/W 5/8"	4	4150 0945 01
Collet type 1b		
Nut	1a	4150 0849 00
Collet Ø 6 mm	1b	4150 1453 00
Collet Ø 8 mm	1b	4150 0706 00
Collet Ø 9 mm	1b	4150 0765 00
Collet Ø 10 mm	1b	4150 0681 00
Collet Ø 1/4"	1b	4150 1754 00
Collet holder	1c	4150 0680 01

NOTE: Adapters are not included with the tool, and need to be ordered to attach a cone wheel.

Productivity Kits

Model	Air inlet BSP	Max air flow	Hose, 5 m	Coupling	Lubrication	Ordering No.
MIDI Optimizer F/RD EQ10-R13-W, incl. whiphose	3/8	23 l/s	Rubair 13 mm	ErgoQIC 10	Yes	8202 0850 14
MIDI Optimizer F/RD EQ10-R13-W, incl. whiphose	-	23 l/s	Rubair 13 mm	ErgoQIC 10	Yes	8202 0850 15
MIDI Optimizer F/RD EQ10-T13	3/8	35 l/s	Turbo 13 mm	ErgoQIC 10	Yes	8202 0850 17
MIDI Optimizer F/R EQ10-T13	1/2	35 l/s	Turbo 13 mm	ErgoQIC 10	No	8202 0850 04
MIDI Optimizer F/RD EQ10-T13	1/2	35 l/s	Turbo 13 mm	ErgoQIC 10	Yes	8202 0850 13
MIDI Optimizer F/RD EQ10-T16	1/2	40 l/s	Turbo 16 mm	ErgoQIC 10	Yes	8202 0850 12
MAXI F/R C-T16	1/2	60 l/s	Turbo 16 mm	Claw	No	8202 0850 05
MAXI F/RD C-T20	1/2	65 l/s	Turbo 20 mm	Claw	No	8202 0850 20



Service Kits

28 series	4081 0315 90
38 series	4081 0311 90
43 series	4081 0020 90
48 series	4081 2023 90

Straight Grinders

For Straight Wheels

Atlas Copco straight grinders, equipped with a straight type 1 grinding wheel, offer a high rate of material removal in open spaces.

The power ranges from 0.6 kW to 2.9 kW.

- The LSR28 is suitable for lighter applications where accessibility is first priority. Low sound and low vibration levels thanks to the unique vibration damping system. Thermally insulated throttle handle and piped away exhaust air are some of the LSR28 product features, all designed for the best comfort for the operator.
- LSR43 has a proven and rigid design, and is suitable for those really tough applications where durability is needed.
- If you need maximum power, then LSR48 or LSR64 is the choice. 2.9 kW in combination with auto balancer for even less vibrations (LSR48). The length of these grinders can be used as a lever for higher feed force.

The LSR48 has minimal vibration levels thanks to the autobalancer and is equipped with an overspeed shut-off device.



Model	Max free speed r/min	For wheel dia. DxTxH mm	Spindle thread and length	Max output		Weight		Length mm	Air consumption at				Rec. hose size		Air inlet thread BSP	Ordering No.
				kW	hp	kg	lb		max output l/s	free speed cfm	l/s	cfm	mm	in		
LSR28 S180-05	18000	50x13x10	UNF 3/8x42	0.82	1.09	1.9	4.1	340	19.8	42.0	7.3	15.5	13	3/8	1/2	8423 1325 04
LSR28 S150-10	15000	100x13x20	UNC 1/2x42	0.70	0.94	2.2	4.8	340	18.0	38.2	5.8	12.3	13	3/8	1/2	8423 1325 02
LSR28 S110-08	11000	80x13x10	UNF 3/8x42	0.62	0.83	1.9	4.2	340	15.8	33.5	3.6	7.6	13	3/8	1/2	8423 1325 03
LSR43 S150-10	15000	100x25x25	UNC 1/2x49	1.0	1.4	2.8	6.2	460	23.0	49.0	10.0	21.0	13	1/2	1/2	8423 1430 34
LSR43 S120-08	12000	80x25x13	UNC 1/2x49	0.9	1.2	2.5	5.5	460	20.0	42.0	7.0	15.0	13	1/2	1/2	8423 1430 26
LSR43 S090-10	9000	100x25x13	UNC 1/2x49	0.8	1.1	2.4	5.3	460	18.0	38.0	5.0	11.0	13	1/2	1/2	8423 1430 18
LSR48 S150-10	15000	100x25x16-25	UNC 5/8x42	2.0	2.7	3.5	7.7	499	35.0	74.0	19.0	40.0	16	5/8	1/2	8423 1430 07
LSR48 S120-08 ^a	12000	80x25x13-25	UNC 1/2x37	1.8	2.4	3.0	6.6	498	30.0	64.0	13.0	28.0	16	5/8	1/2	8423 1430 04
LSR48 S120-10	12000	100x32x16-25	UNC 5/8x49	1.8	2.4	3.5	7.7	495	30.0	64.0	13.0	28.0	16	5/8	1/2	8423 1430 09
LSR48 S120-13	12000	125x25x16-25	UNC 5/8x42	1.8	2.4	3.6	7.9	487	30.0	64.0	13.0	28.0	16	5/8	1/2	8423 1430 06
LSR48 S090-10 ^a	9000	100x25x13-25	UNC 1/2x37	1.5	2.0	3.2	7.0	495	28.0	59.0	11.0	23.0	16	5/8	1/2	8423 1430 02
LSR64 S100-15	10000	150x25x25	UNC 5/8x55	2.9	4.0	5.8	2.8	535	53.0	112.0	26.0	55.0	16	5/8	1/2	8423 1640 55
LSR64 S072-13	7200	125x25x16	UNC 5/8x55	2.5	3.4	5.4	11.9	535	45.0	95.0	14.0	30.0	16	5/8	1/2	8423 1640 30
LSR64 S060-15	6000	150x25x16	UNC 5/8x55	2.3	3.1	5.4	11.9	535	41.0	87.0	11.0	23.0	16	5/8	1/2	8423 1640 22

DxTxH = Diameter x Thickness x Hole.

^a LSR48 S120-08 and LSR48 S090-10 are equipped with closed wheel guard.

Model	Max free speed r/min	Spindle thread and length	Max output		Weight		Length mm	Air consumption at				Rec. hose size		Air inlet thread BSP	Ordering No.	
			kW	hp	kg	lb		max output l/s	free speed cfm	l/s	cfm	mm	in			
For wire brushes																
LSR28 ST070E-CW	7000	UNC 1/2 x 29	0.76	1.00	1.9	4.3	357	18.9	40.1	12.4	26.3	10	3/8	3/8	8423 1235 71	
LSR64 S041	4100	UNC 5/8 x 55	1.6	2.5	5.4	11.9	535	29.0	61.0	7.0	15.0	16	5/8	1/2	8423 1640 14	

Accessories Included

LSR28

Wheel guard, size according to type
Nut, flanges
Air hose, air hose nipple and clamp
Exhaust hose
Wrenches

LSR43

Wheel guard, size according to type
Nut
Flanges
Pin key

LSR48

Whip hose
Hook wrench
Pin key
Wheel guard, size according to type
Flanges that suit wheels with inner diameter of 13/16/20 and 25 mm

LSR64

Wheel guard, size according to type
Nut, flanges
Air hose nipple and clamp
Wrenches

Optional Accessories

	LSR28	LSR43	LSR64	See ill.
Flange				
for 125-150x25x32 wheel	-	-	4150 0620 00	2a
for 80x19x10 wheel	4150 1268 05 ^b	-	-	2a
Silencer	-	4150 1005 80 ^a	-	2b
Exhaust guard	-	4150 0938 80	4150 0968 80	2c
Spacer	-	-	4150 0787 00 ^c	3

^a Can reduce sound level by 8-12 dB.

^b Suits LSR28 S110-08.

^c Spacer to fit cone wheel.

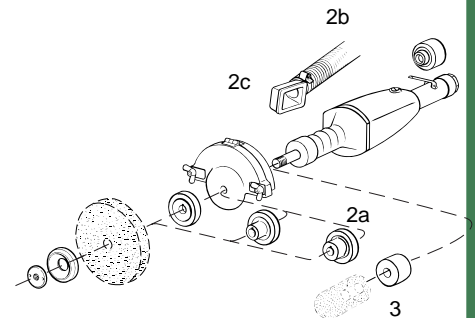

Productivity Kits

Model	Air inlet BSP	Max air flow	Hose, 5 m	Coupling	Lubrication	Ordering No.
MIDI Optimizer F/RD EQ10-R13-W, incl. whiphose	3/8	23 l/s	Rubair 13 mm	ErgoQIC 10	Yes	8202 0850 14
MIDI Optimizer F/RD EQ10-R13-W, incl. whiphose	-	23 l/s	Rubair 13 mm	ErgoQIC 10	Yes	8202 0850 15
MIDI Optimizer F/RD EQ10-T13	3/8	35 l/s	Turbo 13 mm	ErgoQIC 10	Yes	8202 0850 17
MIDI Optimizer F/R EQ10-T13	1/2	35 l/s	Turbo 13 mm	ErgoQIC 10	No	8202 0850 04
MIDI Optimizer F/RD EQ10-T13	1/2	35 l/s	Turbo 13 mm	ErgoQIC 10	Yes	8202 0850 13
MIDI Optimizer F/RD EQ10-T16	1/2	40 l/s	Turbo 16 mm	ErgoQIC 10	Yes	8202 0850 12
MAXI F/R C-T16	1/2	60 l/s	Turbo 16 mm	Claw	No	8202 0850 05
MAXI F/RD C-T20	1/2	65 l/s	Turbo 20 mm	Claw	No	8202 0850 20



Service Kits

28 series	4081 0317 90
43 series	4081 0020 90
48 series	4081 2023 90
64 series	4081 0138 90

Vertical Grinders For Depressed Center, Cut-off and Cup Wheels

The rigid design with a vertically standing air motor and nodular cast iron cylinder gives impressively long service life and durability. The nodular cast iron has a "lubricating" effect, which prolongs the intervals between services.

- LSS series is suitable for rough grinding and cutting off operations on open surfaces.
- The power is impressive and ranges from 1.4 kW to a massive 3.8 kW.
- LSS53 is equipped with a unique silencer that reduces the sound peaks created at start and shut-off.



Model	Max free speed r/min	For wheel dia mm	Spindle thread and length	Max output		Weight		Height over spindle mm	Air consumption at				Rec. hose size		Air inlet thread BSP	Ordering No.
				kW	hp	kg	lb		max output l/s	free speed cfm	l/s	cfm	mm	in		
LSS53 S072-C13	7200	125	UNC 5/8x30	1.3	1.8	3.1	6.8	180	26.0	55.0	8.0	17.0	13	1/2	1/2	8423 2534 12
LSS53 S085-18	8500	180	UNC 5/8x30	1.4	1.9	2.9	6.4	180	27.0	57.0	10.0	21.0	13	1/2	1/2	8423 2530 72
LSS64 S060-23	6000	230	UNC 5/8x31	2.2	3.0	5.1	12.6	201	40.0	85.0	9.0	19.0	16	5/8	1/2	8423 2641 46
LSS64 S060-C15	6000	150	UNC 5/8x31	2.2	3.0	5.0	11.0	201	40.0	85.0	9.0	19.0	16	5/8	1/2	8423 2641 04
LSS64 S085-18	8500	180	UNC 5/8x31	2.6	3.5	4.7	10.4	201	50.0	106.0	13.0	28.0	16	5/8	1/2	8423 2641 38
LSS84 S060-23	6000	230	UNC 5/8x32	3.8	5.1	6.0	13.2	217	65.0	138.0	17.0	36.0	19	3/4	1/2	8423 2840 26

- 13 = 125 mm wheel.
- 18 = 180 mm wheel.
- 23 = 230 mm wheel.
- C13 = 125 mm cup wheel.
- C15 = 150 mm cup wheel.

Accessories Included

Attachment according to EN 68

Wheel guard	
Flange	4170 0758 01
Nut	4170 0220 01
Wrenches	

Optional Accessories

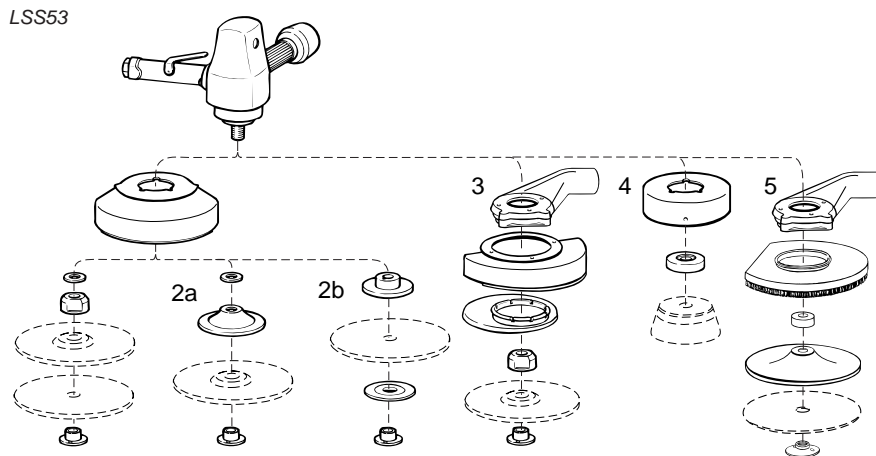

	LSS53	LSS64	LSS84	See illustration
Accessory for depressed center wheel Includes: Rear and outer flange, nut and pin wrench	4170 0219 87	4170 0219 87	-	2a
Accessory for cut off wheel Includes: Rear and outer flange, nut and pin wrench	4170 1133 87	-	-	2b
Accessory for cup wheel 125 mm Includes: Wheel guard and flange	4170 0664 80	-	-	4
Accessory for cup wheel 150 mm Includes: Wheel guard and flange	-	4170 0652 80	-	4
Spot suction kit for depressed center wheel 180 mm	3780 4011 10	-	-	3
Spot suction kit for fibre disc 180 mm	3780 4011 00	-	-	5

Productivity Kits

Model	Air inlet BSP	Max air flow	Hose, 5 m	Coupling	Lubrication	Ordering No.
MIDI Optimizer F/RD EQ10-R13-W, incl. whiphose	3/8"	23 l/s	Rubair 13 mm	ErgoQIC 10	Yes	8202 0850 14
MIDI Optimizer F/RD EQ10-R13-W, incl. whiphose	-	23 l/s	Rubair 13 mm	ErgoQIC 10	Yes	8202 0850 15
MIDI Optimizer F/RD EQ10-T13	3/8"	35 l/s	Turbo 13 mm	ErgoQIC 10	Yes	8202 0850 17
MIDI Optimizer F/R EQ10-T13	1/2"	35 l/s	Turbo 13 mm	ErgoQIC 10	No	8202 0850 04
MIDI Optimizer F/RD EQ10-T13	1/2"	35 l/s	Turbo 13 mm	ErgoQIC 10	Yes	8202 0850 13
MIDI Optimizer F/RD EQ10-T16	1/2"	40 l/s	Turbo 16 mm	ErgoQIC 10	Yes	8202 0850 12
MAXI F/R C-T16	1/2"	60 l/s	Turbo 16 mm	Claw	No	8202 0850 05
MAXI F/RD C-T20	1/2"	65 l/s	Turbo 20 mm	Claw	No	8202 0850 20



Service Kits

LSS53	4081 0132 90
LSS64	4081 0133 90
LSS84	4081 0136 90

Surface sanding jobs with coarse grit fiber discs on stiff pads or with wire brushes, require power. The Atlas Copco LSS series are reliable workhorses with lots of power that will be at your service for a long time. The rigid design with a vertically standing air motor and nodular cast iron cylinder gives impressively long service life and durability. The nodular cast iron has a "lubricating" effect, which prolongs the interval between services.

- LSS series is a good choice in applications where accessibility is of less importance.
- LSS53 is equipped with a unique silencer that reduces the sound peaks created at start and shut-off.



LSS53



LSS64

Model	Max free speed r/min	Rec. pad size dia mm	Spindle thread and length	Max output		Weight		Height over spindle mm	Air consumption at				Rec. hose size		Air inlet thread BSP	Ordering No.
				kW	hp	kg	lb		max output		free speed		mm	in		
									l/s	cfm	l/s	cfm				
LSS53 S060	6000	180	UNC 5/8 x 30	1.2	1.6	2.3	5.1	180	24.0	51.0	7.0	15.0	13	1/2	1/2	8423 2530 23
LSS53 S060-M14	6000	180	M14 x 31	1.2	1.6	2.3	5.1	180	24.0	51.0	7.0	15.0	13	1/2	1/2	8423 2530 27

Optional Accessories

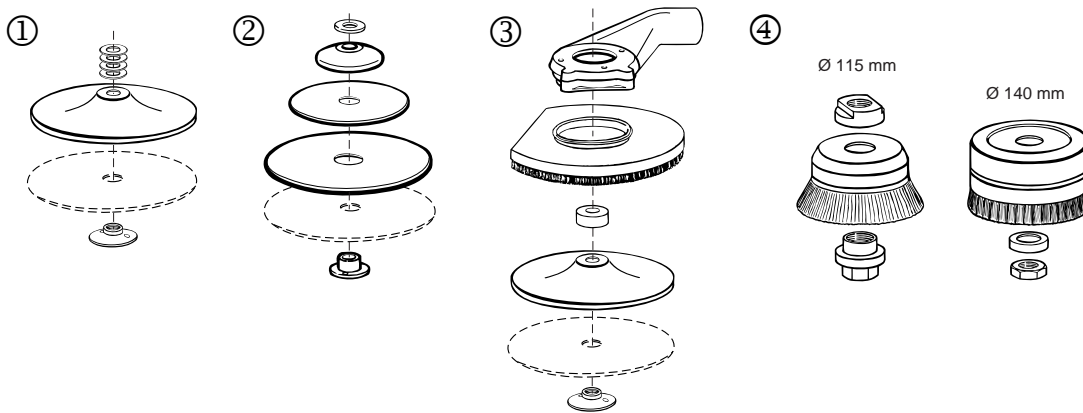

Backing set for LSS53 and LSS64	Soft	Medium	Stiff	See illustration
Standard type Ø 125 mm - M14 and 5/8"	4170 0768 80	-	-	1
Standard type Ø 180 mm - M14 and 5/8"	4170 0756 80	-	4170 0757 80	1
Medium rough type - Ø 125-230 - 5/8"	-	4170 0259 80 ^a	-	2
Heavy duty type - Ø 180 mm - 5/8"	4170 0660 81 ^b	4170 0660 82 ^b	4170 0660 83 ^b	
Backing set with cooling ribs				
Ø 125 mm - 5/8" and M14	-	4150 1962 80	-	-
Ø 180 mm - 5/8" and M14	-	4150 1962 81	4150 1962 83	-
Spot suction kit for fiber disc				
	LSS53	LSS64		See illustration
Ø 180 mm	3780 4011 00 ^c	-		3
Wire brushes				
	LSS53	LSS64		See illustration
Wire brush 115 mm	4170 0491 00	-	-	4
Wire brush 140 mm	-	4170 0685 00	-	4
Attachment set for wire brush	4170 0459 81	4170 0550 80	-	4

^a = Includes three pads 125,180 and 230 mm, washer, hub, nut and wrench.

^b = Includes washers, rubber hub, back-up pad, nut, wrench.

^c = Includes flow chamber, cap, washers, backingpad, nut.

Productivity Kits

Model	Air inlet BSP	Max air flow	Hose, 5 m	Coupling	Lubrication	Ordering No.
MIDI Optimizer F/RD EQ10-R13-W, incl. whiphose	3/8	23 l/s	Rubair 13 mm	ErgoQIC 10	Yes	8202 0850 14
MIDI Optimizer F/RD EQ10-R13-W, incl. whiphose	-	23 l/s	Rubair 13 mm	ErgoQIC 10	Yes	8202 0850 15
MIDI Optimizer F/RD EQ10-T13	3/8	35 l/s	Turbo 13 mm	ErgoQIC 10	Yes	8202 0850 17
MIDI Optimizer F/R EQ10-T13	1/2	35 l/s	Turbo 13 mm	ErgoQIC 10	No	8202 0850 04
MIDI Optimizer F/RD EQ10-T13	1/2	35 l/s	Turbo 13 mm	ErgoQIC 10	Yes	8202 0850 13
MIDI Optimizer F/RD EQ10-T16	1/2	40 l/s	Turbo 16 mm	ErgoQIC 10	Yes	8202 0850 12
MAXI F/R C-T16	1/2	60 l/s	Turbo 16 mm	Claw	No	8202 0850 05
MAXI F/RD C-T20	1/2	65 l/s	Turbo 20 mm	Claw	No	8202 0850 20



Service Kits

LSS53	4081 0132 90
LSS64	4081 0133 90

Angle Grinders

For Depressed Center and Cut-off Wheels

No matter which of our vane grinders you choose you will get durable tools with high power and low weight. In addition, vibrations and noise are on a low level.

- LSV19** – For work in cramped spaces, the LSV19 is small yet powerful, and lubrication free.
 Features: Speed governor, sealed angle head, thermally insulated handle and lubrication-free air motor.
- LSV28** – Small, yet powerful giving 0.75 kW. Available in an extended version for optimal accessibility.
 Features: Speed governor, sealed angle head, thermally insulated handle and lubrication-free air motor (LSV28 S060-18 model).
- LSV38** – If you are looking for the most powerful one-hand angle grinder on the market, then you have found it – up to 1.3 kW.
 Features: Speed governor, sealed angle head, lubrication-free air motor, lockable spindle and thermally insulated handle. The auto balancer (SA models) reduces the vibrations by up to 50%.
- LSV48** – Our most powerful angle vane grinder with 1.9 kW for ultimate productivity.
 Features: Speed governor, sealed angle head, lubrication-free air motor, lockable spindle and thermally insulated handle. The autobalancer reduces the vibrations by up to 50%.



Model	Max free speed r/min	For wheel dia DxTxH ^a mm	Spindle thread and length	Max output		Weight		Height over spindle mm	Air consumption at				Rec. hose size		Air inlet thread BSP	Ordering No.
				kW	hp	kg	lb		max output l/s	free speed cfm	l/s	cfm	mm	in		
LSV19 S170-08	17000	80x7x10	UNF 3/8x17	0.45	0.60	0.7	1.6	71	11.2	23.0	6.6	14.0	10	3/8	1/4	8423 0111 40
LSV28 ST13-10E	13000	100x7x9.5	UNF 3/8x17	0.75	1.00	1.5	3.3	70	21.5	45.0	14.5	30.0	10	3/8	3/8	8423 0125 29
LSV28 ST12-10	12000	100x7x16	UNF 3/8x17	0.75	1.00	1.7	3.7	80	17.4	36.9	7.5	15.9	10	3/8	3/8	8423 0125 14
LSV28 ST12-12	12000	115x7x22	UNF 3/8x17	0.75	1.00	1.7	3.7	80	17.4	36.9	7.5	15.9	10	3/8	3/8	8423 0125 16
LSV28 ST12-13	12000	125x7x22	UNF 3/8x17	0.75	1.00	1.7	3.7	80	17.4	36.9	7.5	15.9	10	3/8	3/8	8423 0125 17
LSV28 S060-18	6000	180 ^b	UNC 5/8x32	0.73	0.98	2.5	5.4	87	16.0	33.9	7.3	15.5	10	3/8	3/8	8423 0135 53
LSV38 S12-125	12000	125x7x22	M14x12	1.30	1.70	1.6	3.5	89	28.0	58.0	15.0	31.0	13	1/2	3/8	8423 0131 08
LSV38 ST12-125	12000	125x7x22	M14x12	1.30	1.70	1.8	4.0	89	28.0	58.0	15.0	31.0	13	1/2	3/8	8423 0131 09
LSV38 SA12-125	12000	125x7x22	M14x10	1.30	1.70	2.0	4.4	89	28.0	58.0	15.0	31.0	13	1/2	3/8	8423 0131 13
LSV48 SA120-13	12000	125x7x22	M14x9	1.9	2.5	2.5	5.5	78	36.0	76.0	17.0	36.0	16	5/8	1/2	8423 0132 07
LSV48 SA085-18	8500	180x7x22	M14x9	1.9	2.5	2.7	5.9	88	36.0	76.0	17.0	36.0	16	5/8	1/2	8423 0132 06
LSV48 SA066-23	6600	230x7x22	UNC 5/8x10	1.9	2.5	2.9	6.4	88	36.0	76.0	17.0	36.0	16	5/8	1/2	8423 0132 08

^a DxTxH = Diameter x Thickness x Hole.

^b Specially for flexible depressed center wheel.

SA = Autobalancer.

E = Extended version.

With wheel guard for wheel diam. -08 = Ø 75 mm
 -10 = Ø 100 mm
 -12 = Ø 115 mm
 -13 = Ø 125 mm
 -18 = Ø 180 mm
 -23 = Ø 230 mm



Service Kits

LSV19	4081 0486 90
LSV28	4081 0317 90
LSV38	4081 0309 90
LSV48	4081 0312 90

Accessories Included

LSV19

Wheel guard 80 mm
 Flanges 4150 1158 80
 Air hose nipple, clamp
 Wrenches
 Exhaust hose set

LSV28

Wheel guard
 Flanges 4150 1160 80
 Support handle 4150 1521 80
 Air hose, air hose nipple, clamp
 Wrenches
 Exhaust hose set

LSV38

Wheel guard (LSV38 S)
 Adjustable wheel guard (LSV38 ST, -SA)
 Wheel attachment flanges
 Wrenches for flanges
 Spindle lock
 Soft grip support handle
 Exhaust hose (LSV38 ST)
 Reinforced exhaust hose (LSV38 SA)
 Autobalancer (LSV38 SA)
 Whip hose Turbo 13 with ErgoNIP 10 (LSV38 ST, -SA)

LSV48

Wheel guard
 Flange nut 4150 1160 02
 Support handle 4175 0868 82

Optional Accessories

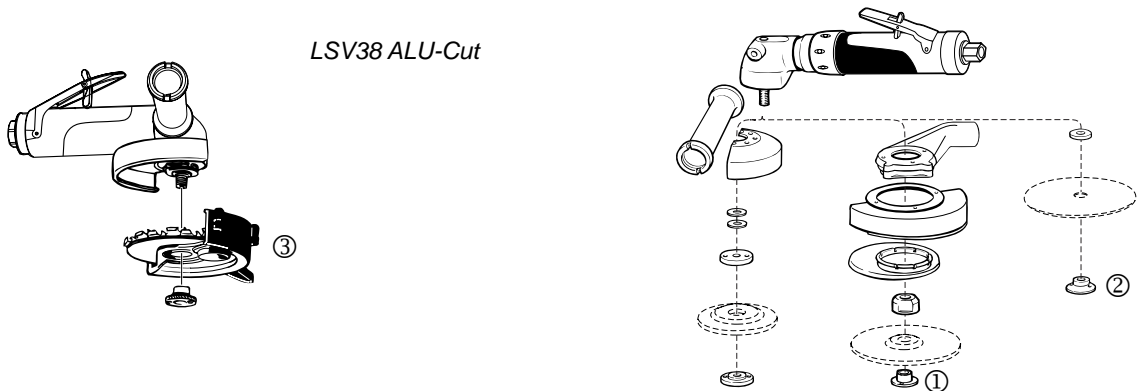

	LSV28	LSV38	LSV48	See illustration
Spot suction kit for depressed center wheel				
Ø 125 mm	3780 4008 70	3780 4008 73	-	1
Ø 180 mm	-	-	3780 4093 41	1
Spot suction for diamond cutting blade				
Ø 125 mm (Cutting depth 30 mm)	-	3780 4008 74	-	-
Ø 180 mm (Cutting depth 50 mm)	-	-	3780 4093 42	-
Diamond cutting blade				
Ø 100 mm	3780 5074 00	-	-	-
Ø 125 mm	-	3780 5074 61	-	-
Ø 180 mm	-	-	3780 5074 62	-
Alu-Cut				
Alu-Cut guard kit	-	4112 1161 90	-	3
Carbide tipped cutter Ø 125 mm, t=2 mm	-	4112 1164 00 ^a	-	-
Carbide tipped cutter Ø 125 mm, t=4 mm	-	4112 1162 00 ^b	-	-
Adapter for fitting flexible depressed center wheel (for LSV28 S060-18)	4170 0759 00	-	-	2

^a For cutting applications in aluminum.

^b For milling applications in aluminum.

Productivity Kits

Model	Air inlet BSP	Max air flow	Hose, 5 m	Coupling	Lubrication	Ordering No.
MIDI Optimizer F/RD EQ10-R13-W, incl. whiphose	3/8	23 l/s	Rubair 13 mm	ErgoQIC 10	Yes	8202 0850 14
MIDI Optimizer F/RD EQ10-R13-W, incl. whiphose	-	23 l/s	Rubair 13 mm	ErgoQIC 10	Yes	8202 0850 15
MIDI Optimizer F/RD EQ10-T13	3/8	35 l/s	Turbo 13 mm	ErgoQIC 10	Yes	8202 0850 17
MIDI Optimizer F/R EQ10-T13	1/2	35 l/s	Turbo 13 mm	ErgoQIC 10	No	8202 0850 04
MIDI Optimizer F/RD EQ10-T13	1/2	35 l/s	Turbo 13 mm	ErgoQIC 10	Yes	8202 0850 13
MIDI Optimizer F/RD EQ10-T16	1/2	40 l/s	Turbo 16 mm	ErgoQIC 10	Yes	8202 0850 12
MAXI F/R C-T16	1/2	60 l/s	Turbo 16 mm	Claw	No	8202 0850 05
MAXI F/RD C-T20	1/2	65 l/s	Turbo 20 mm	Claw	No	8202 0850 20

Angle Sanders

For Sanding and Polishing

- LSV12 series sander** – For finer work where less power and more control are needed. Available with collet or threaded spindle.
 Features: Speed governor, high quality gears and lever with feathering characteristics.
- LSV28 series sander** – The 28 series comes in various speeds and in a wet sanding version. Wet sanders have central water supply (water feed through the angle head) for optimal water distribution on the work surface.
 Features: Speed governor, sealed angle head, LF models have lubrication-free air motor.
- LSV38 series sander** – Powerful one hand sander for medium rough to rough sanding.
 Features: Speed governor, sealed angle head, lubrication-free air motor and lockable spindle.
- LSV48 series sander** – Our most powerful angle vane sander with 1.9 kW for ultimate productivity.
 Features: Speed governor, sealed angle head, lubrication-free air motor, autobalancer and lockable spindle.



Model	Max free speed r/min	Rec. pad size max dia mm	Spindle thread and length	Max output		Weight		Length mm	Height over spindle mm	Air consumption at				Rec. hose size mm in	Air inlet thread BSP	Ordering No.	
				kW	hp	kg	lb			max output	free speed	l/s	cfm				l/s
With collet																	
LSV12 S200-1	20000	50	— ^a	0.29	0.39	0.5	1.2	166	76	9.5	20.1	6.4	13.6	8	5/16	1/4	8423 1124 06
LSV12 S120-1	12000	75	— ^a	0.24	0.33	0.5	1.2	166	76	8.3	17.6	3.0	6.4	8	5/16	1/4	8423 1124 05
LSV19 S200-1	20000	50	— ^a	0.46	0.62	0.6	1.3	185	79	11.3	23.9	7.5	15.9	10	3/8	1/4	8423 0111 41
LSV19 S120-1	12000	75	— ^a	0.46	0.62	0.6	1.3	185	79	11.3	23.9	7.5	15.9	10	3/8	1/4	8423 0111 43
LSV19 S080-1	8000	75	— ^a	0.37	0.5	0.6	1.3	185	79	11.3	23.9	6.5	13.8	10	3/8	1/4	8423 0111 46
With threaded spindle																	
LSV12 S200	20000	50	UNC 1/4x8	0.29	0.39	0.5	1.2	166	58	8.3	17.6	3.0	6.4	8	5/16	1/4	8423 1124 08
LSV12 S120	12000	75	UNC 1/4x8	0.24	0.33	0.5	1.2	166	58	8.3	17.6	3.0	6.4	8	5/16	1/4	8423 1124 07
LSV19 S200	20000	50	UNC 1/4x8	0.46	0.62	0.6	1.3	185	58	11.3	23.9	7.5	15.9	10	3/8	1/4	8423 0111 42
LSV19 S120	12000	75	UNC 1/4x8	0.46	0.62	0.6	1.3	185	58	11.3	23.9	7.5	15.9	10	3/8	1/4	8423 0111 44
LSV19 S080	8000	75	UNC 1/4x8	0.37	0.5	0.6	1.3	185	58	11.3	23.9	6.5	13.8	10	3/8	1/4	8423 0111 45
Rotary sanders. Dry sanding																	
LSV28 S060	6000	180	UNC 5/8x32	0.73	0.98	1.5	3.2	265	87	16.0	33.9	7.3	15.5	10	3/8	3/8	8423 0125 30
LSV28 S060-M14	6000	180	M14x16	0.73	0.98	1.5	3.2	265	87	16.0	33.9	7.3	15.5	10	3/8	3/8	8423 0125 64
LSV28 S040	4000	180	UNC 5/8x32	0.62	0.83	1.5	3.2	265	87	15.0	31.8	4.0	8.5	10	3/8	3/8	8423 0126 22
LSV28 ST034	3400	180	UNC 5/8x32	0.71	0.95	1.7	3.7	289	87	18.0	38.2	7.7	16.3	10	3/8	3/8	8423 0135 80
LSV28 S021	2100	180	UNC 5/8x32	0.68	0.91	1.9	4.1	289	87	16.0	33.9	5.6	11.9	10	3/8	3/8	8423 0125 19
LSV28 S021-M14	2100	180	M14x16	0.68	0.91	1.9	4.1	289	87	16.0	33.9	5.6	11.9	10	3/8	3/8	8423 0125 72
Wet sanding																	
LSV28 S040-01-M14	4000	180	M14x16	0.62	0.83	1.5	3.2	268	87	15.0	31.8	5.0	10.6	10	3/8	3/8	8423 0125 12
LSV28 ST008-01 LF	800	200	UNC 5/8x32	0.68	0.91	2.0	4.3	307	87	16.0	33.9	5.6	11.9	10	3/8	3/8	8423 0125 51
Lubrication-free. Dry sanding																	
LSV28 ST013-M14 LF	1300	180	M14x16	0.68	0.91	1.7	3.7	289	87	20.0	42.4	9.0	19.1	10	3/8	3/8	8423 0125 28
LSV28 ST013 LF	1300	180	UNC 5/8x32	0.68	0.91	1.7	3.7	289	87	20.0	42.4	9.0	19.1	10	3/8	3/8	8423 0126 26
LSV38 S085	8500	180	UNC 5/8x22	1.30	1.70	1.5	3.3	221	96	28.0	58.0	15.0	31.0	13	1/2	3/8	8423 0130 69
LSV38 S085 D	8500	180	UNC 5/8x28	1.30	1.70	2.3	5.0	221	96	28.0	58.0	15.0	31.0	13	1/2	3/8	8423 0130 76
LSV38 S085-M14	8500	180	M14x12	1.30	1.70	1.5	3.3	221	96	28.0	58.0	15.0	31.0	13	1/2	3/8	8423 0130 72
LSV38 S066	6600	180	UNC 5/8x22	1.20	1.60	1.5	3.3	221	96	24.0	50.0	13.0	27.0	13	1/2	3/8	8423 0130 73
LSV38 S066 D	6600	180	UNC 5/8x28	1.20	1.60	2.3	5.0	221	96	24.0	50.0	13.0	27.0	13	1/2	3/8	8423 0130 75
LSV38 S066-M14	6600	180	M14x12	1.20	1.60	1.5	3.3	221	96	24.0	50.0	13.0	27.0	13	1/2	3/8	8423 0130 77
LSV48 SA085	8500	180	UNC 5/8x21	1.9	2.5	2.3	5.1	316	78	36.0	76.0	17.0	36.0	16	5/8	1/2	8423 0132 02
LSV48 SA085 D	8500	180	UNC 5/8x21	1.9	2.5	2.8	6.2	316	94	36.0	76.0	17.0	36.0	16	5/8	1/2	8423 0132 05
LSV48 SA085-M14	8500	180	M14x18	1.9	2.5	2.3	5.1	316	78	36.0	76.0	17.0	36.0	16	5/8	1/2	8423 0132 03
LSV48 SA066	6600	180	UNC 5/8x21	1.9	2.5	2.3	5.1	316	78	36.0	76.0	17.0	36.0	16	5/8	1/2	8423 0132 00
LSV48 SA066-M14	6600	180	M14x9	1.9	2.5	2.3	5.1	316	78	36.0	76.0	17.0	36.0	16	5/8	1/2	8423 0132 01

^a Ø 6 mm collet. -01 = Wet sanding. -M14 = M14 thread. -SA = Autobalancer.
 -1 = Ø 6 mm collet. -D = Spot suction kit included. -ST = Models with planetary gears.

Accessories Included

Air hose nipple	Exhaust hose (LSV19/28/38)	Wrenches
Clamp	Support handle (LSV28/38/48)	Spot suction equipment (D-version)

Optional Accessories

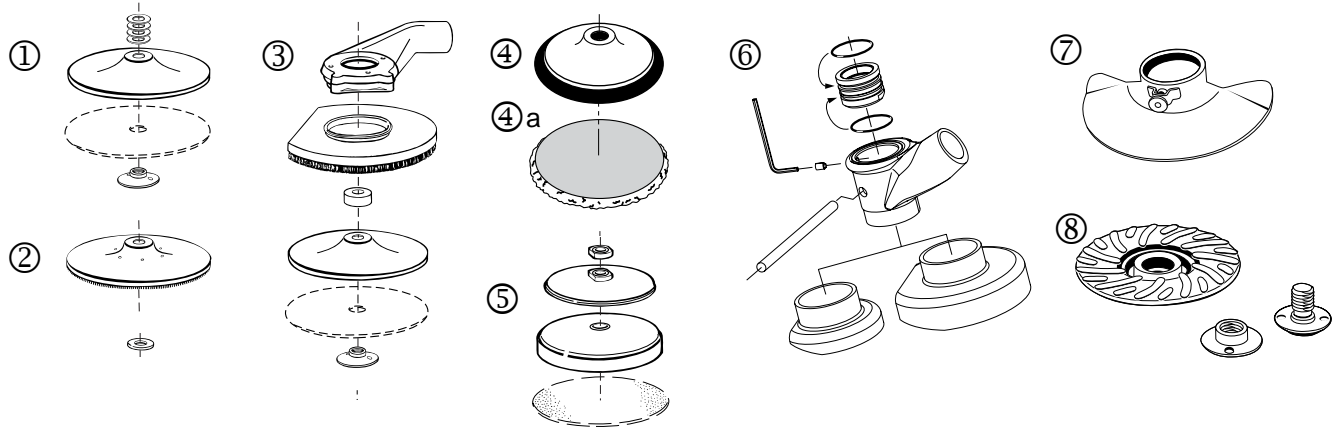

	LSV12	LSV19	LSV28	LSV38	LSV48	See ill.
Backing set, standard type						
Ø 125 mm - 5/8" - soft	-	-	4170 0768 80	4170 0768 80	4170 0768 80	1
Ø 180 mm - 5/8" - soft	-	-	4170 0756 80	4170 0756 80	4170 0756 80	1
Ø 180 mm - 5/8" - stiff	-	-	4170 0757 80	4170 0757 80	4170 0757 80	1
Backing set with cooling ribs						
Ø 125 mm - 5/8" and M14, medium	-	-	4150 1962 80	4150 1962 80	4150 1962 80	2
Ø 180 mm - 5/8" and M14, stiff	-	-	-	4150 1962 83	4150 1962 83	2
Ø 180 mm - 5/8" and M14, medium	-	-	4150 1962 81	4150 1962 81	4150 1962 81	2
Backing set, heavy duty type						
Ø 120 mm - M14	-	-	-	4175 0883 93	4175 0883 93	8
Ø 162 mm - M14	-	-	-	4175 0883 91	4175 0883 91	8
Ø 120 mm - 5/8"	-	-	-	4175 0883 92	4175 0883 92	8
Ø 162 mm - 5/8"	-	-	-	4175 0883 90	4175 0883 90	8
Backing set for polishing - velcro						
Ø 150 mm - 5/8" (max 2500 rpm)	-	-	4112 6092 15	-	-	4
Ø 150 mm - Lambs woll bonnet	-	-	4112 6093 15	-	-	4a
Backing set for wet sanding						
Ø 180 mm - 5/8" - foam rubber (max 2500 rpm)	-	-	4170 0428 83	-	-	5
Spot suction kit for fiber disc						
Ø 125 mm	-	-	3780 4007 80 ^a	3780 4008 85 ^d	-	3
Ø 180 mm	-	-	3780 4007 90 ^{b/}	3780 4008 84 ^e	3780 4093 40	3
			3780 4031 60 ^c			3
Ø 50 - 75 mm	3780 4092 64 ^f	3780 4092 62 ^{g/}	-	-	-	6
		3780 4092 65 ^g				6
Hand shield for 125-180 mm	-	-	-	4150 1936 80	-	7

^a = Suits LSV28 S060

^c = Suits LSV28 S021

^e = Can only be retrofitted on LSV38 D (8423 0800 03 and 8423 0800 04)

^f = For model with collet

^b = Suits LSV28 S040/060

^d = Can only be retrofitted on LSV38 D (8423 0800 02 and 8423 0800 03)

^g = For model with threaded spindle

Productivity Kits

Model	Air inlet	Max	Hose, 5 m	Coupling	Lubrication	Ordering No.
	BSP	air flow				
MIDI Optimizer F/RD EQ10-R13-W, incl. whiphose	3/8	23 l/s	Rubair 13 mm	ErgoQIC 10	Yes	8202 0850 14
MIDI Optimizer F/RD EQ10-R13-W, incl. whiphose	-	23 l/s	Rubair 13 mm	ErgoQIC 10	Yes	8202 0850 15
MIDI Optimizer F/RD EQ10-T13	3/8	35 l/s	Turbo 13 mm	ErgoQIC 10	Yes	8202 0850 17
MIDI Optimizer F/R EQ10-T13	1/2	35 l/s	Turbo 13 mm	ErgoQIC 10	No	8202 0850 04
MIDI Optimizer F/RD EQ10-T13	1/2	35 l/s	Turbo 13 mm	ErgoQIC 10	Yes	8202 0850 13
MIDI Optimizer F/RD EQ10-T16	1/2	40 l/s	Turbo 16 mm	ErgoQIC 10	Yes	8202 0850 12



Service Kits

LSV19	4081 0486 90	LSV38	4081 0309 90
LSV28	4081 0317 90	LSV48	4081 0312 90

Orbital and Random Orbital Sanders

Atlas Copco series of random orbital sanders combines all the important customer and application requirements in a very competitive range of products. Applications like sanding before painting and surface coating, polishing with wax and surface conditioner are all quickly done with the small and easily operated LST20-range of sanders.

All models are lubrication free and have silicone free components. They have two grip options in the same handle. In addition, one smaller grip model is included. The full range includes standard models and extraction models. There are also three orbit diameters to choose from in the model range.

- **Lubrication-free** – Avoids contamination of workpiece. No oil in the exhaust air.



Model	Max free speed r/min	Pad size mm	Orbit dia mm	Max output		Weight		Height over spindle		Air consumption at free speed		Rec. hose size mm	Air inlet thread BSP	Ordering No.
				kW	hp	kg	lb	mm	Length mm	l/s	cfm			
Random orbital – Standard														
LST30 H090-11	9000	110	8	0.3	0.4	1.2	2.6	120	255	7.5	16	8	1/4	8423 0361 64
LST30 H090-15	9000	150	8	0.3	0.4	1.2	2.6	120	275	7.5	16	8	1/4	8423 0361 72
LST30 S090-15	9000	150	8	0.3	0.4	1.1	2.4	120	175	7.5	16	8	1/4	8423 0361 98
Self suction^a														
LST31 H090-15	9000	150	8	0.3	0.4	1.4	3.0	120	300	7.5	16	8	1/4	8423 0363 19
Central suction^b														
LST32 H090-15	9000	150	8	0.3	0.4	1.4	3.0	120	300	7.5	16	8	1/4	8423 0362 55
LST32 S090-15	9000	150	8	0.3	0.4	1.3	2.9	120	200	7.5	16	8	1/4	8423 0362 71
Orbital – Standard														
LSO30 S070-3	7000	93x170	5	0.3	0.4	1.6	3.5	125	185	7.5	16	8	1/4	8423 0360 16
LSO30 H070-3	7000	93x170	5	0.3	0.4	1.7	3.7	125	285	7.5	16	8	1/4	8423 0360 24
Self suction^a														
LSO31 S070-3	7000	93x170	5	0.3	0.4	1.6	3.5	125	210	7.5	16	8	1/4	8423 0362 79
LSO31 H070-3	7000	93x170	5	0.3	0.4	1.7	3.7	125	310	7.5	16	8	1/4	8423 0363 03
Central suction^c														
LSO32 H070-3	7000	93x170	5	0.3	0.4	1.8	4.0	125	310	7.5	16	8	1/4	8423 0361 07
Standard model														
LST20 R350	12000	90	5	0.2	0.27	0.85	1.85	95	127	8	17	8	1/4	8423 0361 65
LST20 R550	12000	125	5	0.2	0.27	0.85	1.85	83	127	8	17	8	1/4	8423 0361 69
LST20 R650	12000	150	5	0.2	0.27	0.85	1.85	83	127	8	17	8	1/4	8423 0361 73
LST20 R525	12000	125	2.4	0.2	0.27	0.85	1.85	83	127	8	17	8	1/4	8423 0361 81
LST20 R625	12000	150	2.4	0.2	0.27	0.85	1.85	83	127	8	17	8	1/4	8423 0361 84
Extraction model – self suction														
LST21 R350	12000	90	5	0.2	0.27	0.85	1.85	95	133 ^d	8	17	8	1/4	8423 0361 66
LST21 R550	12000	125	5	0.2	0.27	0.85	1.85	83	133 ^d	8	17	8	1/4	8423 0361 70
LST21 R650	12000	150	5	0.2	0.27	0.85	1.85	83	133 ^d	8	17	8	1/4	8423 0361 74
LST21 R525	12000	125	2.4	0.2	0.27	0.85	1.85	83	133 ^d	8	17	8	1/4	8423 0361 82
LST21 R625	12000	150	2.4	0.2	0.27	0.85	1.85	83	133 ^d	8	17	8	1/4	8423 0361 85
Extraction model – central suction^c														
LST22 R550	12000	125	5	0.2	0.27	0.85	1.85	83	133 ^d	8	17	8	1/4	8423 0361 71
LST22 R650	12000	150	5	0.2	0.27	0.85	1.85	83	133 ^d	8	17	8	1/4	8423 0361 75
LST22 R650-9	12000	150	5	0.2	0.27	0.85	1.85	83	133 ^d	8	17	8	1/4	8423 0361 40
LST22 R525	12000	125	2.4	0.2	0.27	0.85	1.85	83	133 ^d	8	17	8	1/4	8423 0361 83
LST22 R625	12000	150	2.4	0.2	0.27	0.85	1.85	83	133 ^d	8	17	8	1/4	8423 0361 86

^a Includes dust collecting bag.

^b Required air flow 150 m³/h or 88 cfm.

^c Required air flow 60 m³/h or 35 cfm.

^d 186 mm (7.3") suction hose connector included.

H = With handle.

S = Without handle.

All data at 6.3 bar.

-9 Velcro pad, 9 holes.

Accessories Included

LSO

- Base pad
- Perforating plate
- Hose nipple for 8 mm hose
- LSO31 including dust collection kit

LST20/21/22

- Velcro pad
- U-wrench for pad change
- Air hose nipple
- Dust hose and bag (LST21)
- Large and small grip cover

LST30/31/32

- Velcro pad
- Bar for changing pad
- Hose nipple for 8 mm hose
- LST31 incl dust collection kit

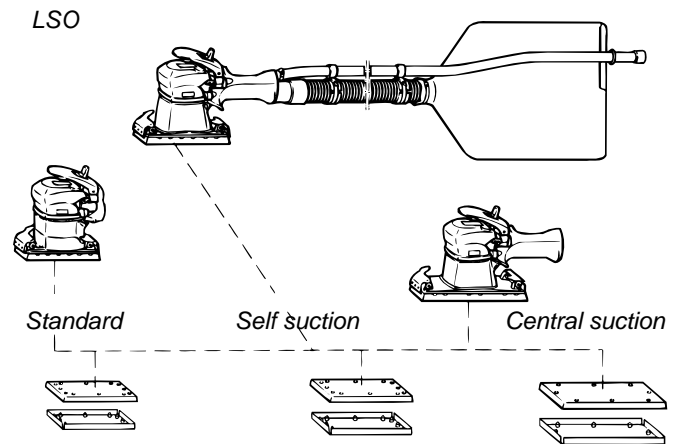

Optional Accessories

LSO

For LSO	Ordering No.
Base pad, vinyl for -3F-type	4112 0787 01
Hose set Dust hose, for LSO32, Ø 32 mm, L=1.8 m including air hose	3780 2724 34

LST20/21/22, pad for self stick paper

	Ordering No.		
	Dia 89 mm	Dia 125 mm	Dia 150 mm
For LST20	4112 1231 00	4112 1233 00	4112 1235 00
For LST21/22	-	4112 1232 00	4112 1234 00

LST20/21/22, pad for velcro back paper

	Ordering No.		
	Dia 89 mm	Dia 125 mm	Dia 150 mm
For LST 20	4112 1218 00	4112 1216 00	4112 1214 00
For LST 21/22	-	4112 1217 00	4112 1215 00

LST30/31/32

	Ordering No.
Pad velcro, Ø 150 mm	4112 0795 02 ^a
Pad velcro, Ø 110 mm	4112 0792 02 ^b
Pad velcro, Ø 150 mm, 6 holes	4112 0796 01 ^c
Hose set Dust hose Ø 32 mm, L=1.8 m including air hose	3780 2724 34 ^d

^aLST30-15 ^bLST30/32-11 ^cLST31/32-15 ^dLST32



Service Kits

LST20/21/22 4112 1300 90

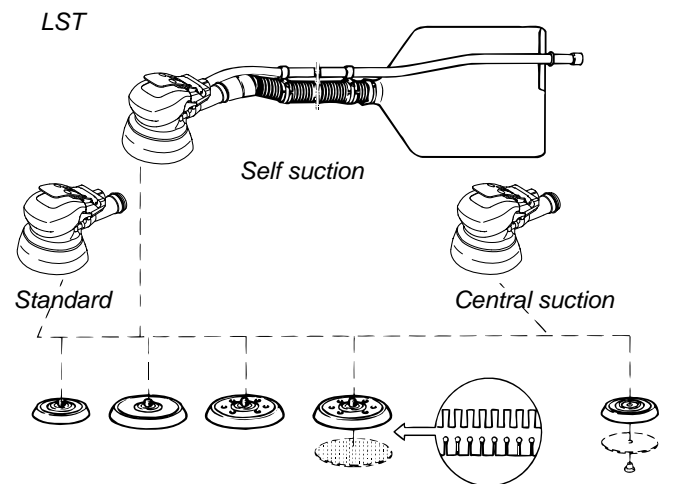

Hole pattern dimensions for sanding paper, dust extraction models

LS031/32/33 S/H070-3 R-type pad

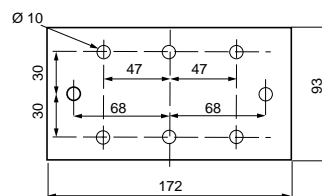

LSO31/32-3 F-type pad

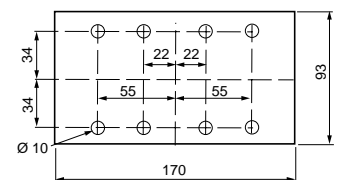

LST20/21/22, 30/31/32

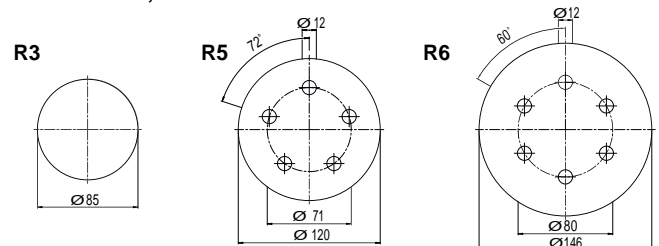

Dust Extraction

The fact that dust can represent a hazard in the working environment is well documented.

Dust particles from certain materials are dangerous to health. Even inert dust particles that cause no permanent damage can still be retained in the body and make breathing more difficult.

Efficient dust control can make a significant contribution to efficiency and productivity in industrial operations. It is already a requirement in countries with strict health and safety regulations.

Efficient dust control will:

- Reduce the health risk for operators exposed to potentially dangerous particles.
- Give a more favourable working environment which will encourage greater efficiency and effort from those who operate industrial tools.

The most efficient method of dust collection is extraction at the point of dust creation, i.e. on the tool itself. This not only ensures very efficient extraction but also allows a relatively low power vacuum source to be used.

Atlas Copco spot suction kits provide an extraction hood fixed to the tool. It is fitted with a plastic or brush edge to trap heavier particles as well as the small



ones. The following pages show a number of applications and the necessary dust extraction kits with their contents.

Model ^a	Max free speed r/min	Max output		Weight		Height over spindle		Air consumption at				Spindle thread	Air inlet thread BSP	Ordering No.
		kW	hp	kg	lb	mm	in	max power l/s	cfm	free speed l/s	cfm			
GTG21 D120	12000	2.1	2.8	1.6	3.5	92	3.6	30	64	10	21	UNC 5/8"-11	3/8	8423 0800 00
GTG21 D085	8500	2.1	2.8	1.6	3.5	92	3.6	30	64	10	21	UNC 5/8"-11	3/8	8423 0800 01
LSV48 SA085	8500	1.9	2.5	2.3	5.1	78	3	36	76	17	36	UNC 5/8x21	1/2	8423 0132 02
LSV48 SA066	6600	1.9	2.5	2.3	5.1	78	3	36	76	17	36	UNC 5/8x21	1/2	8423 0132 00
LSV38 D120	12000	1.3	1.7	2.0	4.4	96	3.8	28	58	15	31	UNC 5/8"-11	1/2	8423 0800 02
LSV38 D085	8500	1.3	1.7	2.0	4.4	96	3.8	28	58	15	31	UNC 5/8"-11	1/2	8423 0800 03
LSV38 D066	6600	1.3	1.7	2.0	4.4	96	3.8	24	50	13	27	UNC 5/8"-11	1/2	8423 0800 04

^a Models prepared for use with spot suction kit, spot suction kits are not included and must be ordered separately, see below.

Spot suction kits for GTG21, LSV48 and LSV38

Model	Ordering No.	Application						
		Grinding Depressed center wheel dia, mm		Sanding Fiber disc dia, mm		Cutting GRP cutting with cutter disc dia, mm		
		125	180	125	180	125	180	
GTG21 D120	8423 0800 00	3780 4090 23		3780 4090 24		3780 4090 25		
GTG21 D085	8423 0800 01		3780 4090 21	3780 4090 24			3780 4090 22	
LSV48 SA085	8423 0132 02		3780 4093 41		3780 4093 40		3780 4093 42	
LSV48 SA066	8423 0132 00				3780 4093 40			
LSV38 D120	8423 0800 02	3780 4008 73		3780 4008 85		3780 4008 74		
LSV38 D085	8423 0800 03			3780 4008 85				
LSV38 D066	8423 0800 04				3780 4008 84			
					3780 4008 84			
Optional accessory								
Cutting disc							3780 5074 61	3780 5074 62

Kits for die grinders

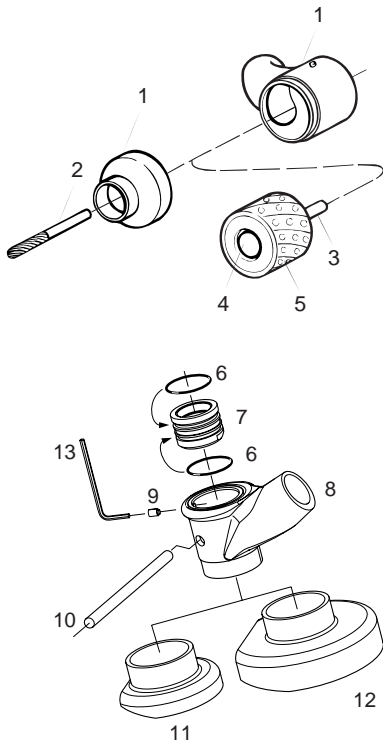

Spot suction kits for die grinders

Suction requirement: 125 m ³ /h (LSF19), 200 m ³ /h (LSF28)		Ordering No.
LSF19 S	KIT for burr	3780 3015 22
	Optional 2 Diamond burr 6 mm	3780 5013 70
LSF19 S	KIT for drum	3780 4011 61
	Includes 3 Shaft dia 6 mm	3780 5090 30
	4 Locking screw	3780 5090 60
	Optional 5 Diamond drum 27 mm	3780 5033 00
LSF28 S	KIT for burr	3780 4007 42
	Optional 2 Diamond burr 6 mm	3780 5013 70
LSF28 S	KIT for drum	3780 4011 73
	Includes 3 Shaft dia 8 mm	3780 5091 00
	Distance nut	3780 5091 50
	4 Locking nut	3780 5092 00
	Optional 5 Diamond drum, Ø 52 mm	3780 5035 00
LSV19 S-1	KIT for sanding pad dia 50 and 75 mm	3780 4092 62
	Includes 6 O-ring 23x1.6	0663 2103 85
	7 Clamp ring	4112 1065 04
	9 Lock screw M4x6 A1	0192 1168 00
	10 Lock pin	4112 0779 00

Kit for depressed center and cut off wheels

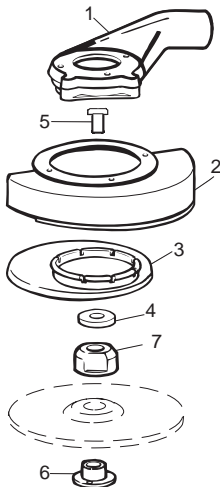

Spot suction kits for depressed center wheels

Suction requirement: 250 m ³ /h		Ordering No.
LSV28 ST12 125 mm wheel	KIT	3780 4008 70
	Includes 5 Adapter UNF 3/8" UNC 5/8"	4021 0457 00
	6 Nut 5/8"	3780 2722 00
LSS53 S085 18 180 mm wheel	KIT	3780 4011 10
	Includes 7 Flange EN 68	4170 0758 00
	6 Nut 5/8"	3780 2722 00

Hose kits including 1.8 m vacuum hose, Ø 38 mm and air hose Ø 13 mm

	Ordering No.
LSV28 (air hose Ø 10 mm for LSV28)	3780 2724 40
LSV38/41, LSS53, GTG21/40	3780 2724 41

Brush for suction cap

	Ordering No.
Separate brush for cap Ø 125 mm	3780 2678 00
Separate brush for cap Ø 180 mm	3780 2677 50
Separate brush (30 mm high) for cap Ø 180 mm	3780 2677 30

Kit for sanding with fiber disc

LSV28/38/48/GTG40

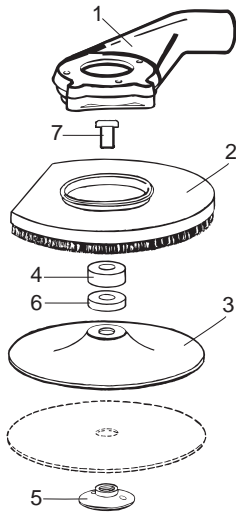

Spot suction kits for sanding with fiber disc. Sanders with UNC 5/8" spindle.

		Suction requirement: 250 m ³ /h		Ordering No.
LSV28 S040/S060 125 mm		KIT		3780 4007 80
	Includes	2	Suction cap 125 mm with brush	3780 2650 20
		3	Backing pad 125 mm	3780 2710 30
		4	Distance washer 12 mm	3780 2721 60
		5	Nut 5/8"	3780 2722 00
LSV28 ST12-13 125 mm		KIT		3780 4008 60
	Includes	2	Suction cap 125 mm with brush	3780 2650 20
		3	Backing pad 125 mm	3780 2710 30
		6	Distance washer 9 mm	3780 2721 50
		7	Adapter UNF 3/8" UNC 5/8"	4021 0457 00
		5	Nut 5/8"	3780 2722 00
LSV28 S040/S060 180 mm		KIT		3780 4007 90
	Includes	2	Suction cap 180 mm with brush	3780 2675 00
		3	Backing pad 180 mm	3780 2710 60
		6	Distance washer 9 mm	3780 2721 50
		5	Nut 5/8"	3780 2726 70
LSV28 S021 180 mm		KIT		3780 4031 60
	Includes	2	Suction cap 180 mm with brush	3780 2675 00
		3	Backing pad	3780 2710 60
		6	Distance washer 12 mm	3780 2721 60
		5	Nut 5/8"	3780 2726 70
LSV38 D066/D085 180 mm		KIT		3780 4008 84
	Includes	2	Suction cap 180 mm with brush	3780 2675 00
		3	Backing pad 180 mm	3780 2710 60
		5	Nut 5/8"	3780 2726 70
		6	Distance washer 9 mm	3780 2721 50
LSV38 D085/D120 125 mm		KIT		3780 4008 85
	Includes	2	Suction cap 125 mm with brush	3780 2650 20
		3	Backing pad 125 mm	3780 2710 30
		5	Nut 5/8"	3780 2726 70
		6	Distance washer 9 mm	3780 2721 50
LSV48 SA066/SA085 180 mm		KIT		3780 4093 40
	Includes	2	Suction cap 180 mm with brush	3780 2675 00
		3	Backing pad 180 mm	3780 2710 60
		4	Distance washer 9 mm	3780 2721 50
		5	Nut 5/8"	3780 2726 70
LSS53 S060 180 mm		KIT		3780 4011 00
	Includes	2	Suction cap 180 mm with brush	3780 2675 00
		3	Backing pad 180 mm	3780 2710 60
		4	Distance washer 12 mm	3780 2721 60
		5	Nut 5/8"	3780 2726 70
GTG40 S060 180 mm		KIT		3780 4090 11
	Includes	2	Suction cap 180 mm with brush	3780 2675 31
		3	Backing pad 180 mm	3780 2710 60
		4	Distance washer 6 mm	3780 2721 40
		5	Nut 5/8"	3780 2722 00

Kit for GRP-cutting

LSV48

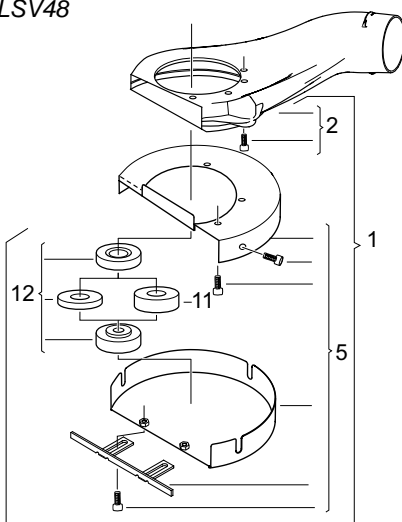

Spot suction kit for GRP-cutting

		Suction requirement: 250 m ³ /h		Ordering No.
LSV48 SA085/SA066 180 mm		KIT		3780 4093 42
	Includes	12	Flange set	3780 2799 50
	Optional		180 mm cutting-off disc	3780 5074 62

Router

Pattern fixture cutting of composite in the aerospace industry as well as trimming of composite materials is preferably done with a router. The LSK is the only router with dust extraction and support bearing integrated into one unit. This gives the LSK excellent performance and ergonomics in most composite applications.

- **Productive** – The speed governor maintains the rotational speed at applied feed force which enables fast and effective cutting and prevents the bit from clogging.
- **Ergonomic** – An integrated dust extraction hood for deportation of hazardous dust, thermally insulated throttle handle, sound dampening exhaust valve and piped-away exhaust air provides the operator with the best working environment.

Cutting operations in glass and carbon fiber as well as metal sheet, wood and steel can successfully be performed with a circular cutter.



LSK38

Model	Free speed r/min	Collet size	Weight		Power		Air consumption		Rec. hose size		Hose fitting thread BSP	Ordering No.
			kg	lb	kW	hp	l/s	cfm	mm	in		
LSK37 S250-DS1	25000	6 mm	2.8	6.1	0.7	0.95	18	32	13	1/2	3/8	8423 1234 41
LSK37 S250-DS2	25000	1/4	2.8	6.1	0.7	0.95	18	32	13	1/2	3/8	8423 1234 42
LSK38 S250 Do	25000	1/4	1.1	2.2	1.3	1.8	28	58	13	1/2	3/8	8423 0700 00
LSK38 S180 Do	18000	1/4	1.1	2.2	1.3	1.8	28	58	13	1/2	3/8	8423 0700 01

Suction requirement: 200 m³/h. **NOTE:** LSK38 delivered without rotor housing

- **Effective** – LCS10 and LCS38 cut to a depth of 10 and 26 mm respectively.
- LCS38 is suitable for diamond coated blades only.
- **Dust extraction** – Cutting of composite materials generates dust containing particles that are hazardous to health. The dust must be deported in order to prevent the operator from inhaling it.

LCS38 is equipped with a cutter blade guard with integrated dust extraction hood for external vacuum source.

LCS10

Cutter blade, 62 teeth
Hexagon wrench
Hose nipple for 6.3 mm air hose

LCS38

LCS38



LCS10



Model	Free speed r/min	Max output		Max cutting depth mm	Max cutter blade dia mm	Weight		Air consumption at free speed		Rec. hose size		Air inlet thread BSP	Ordering No.
		kW	hp			kg	lb	l/s	cfm	mm	in		
LCS10	3000	0.3	0.4	10	50	1.4	3.1	7.6	16	6.3	1/4	1/4	8424 1161 38
LCS38 S150D ^a	15000	1.3	1.7	26	100	1.7	3.7	28.0	58	13.0	1/2	3/8	8424 1125 06

^a Suction requirement: 200 m³/h.

Accessories Included

Flanges for diamond blade
Hose nipple for 13 mm air hose

Optional Accessories

Cutter blades

Model	Application	Max thickness of material mm	No. of teeth mm	Dia mm	Hole mm	Ordering No.
LCS10	Steel sheet	1.0	92	50	10	4190 0394 00
	Steel sheet	1.0	62	50	10	4190 0395 00 (std)
	Aluminum	2.5	34	50	10	4190 0396 00
	Wood	10.0	34	50	10	4190 0396 00
LCS38	Glassfibre	18.0	44/60 (Grain)	75	12	3780 5073 00
	Glassfibre	25.0	44/60 (Grain)	100	12	3780 5074 00

Model	Ordering No.
Suction hose set (L= 150 mm, Dia 1 1/4") for LCS38	3780 2724 31
Bladeguard for LCS10	4150 1964 00

Productivity Kits

Model	Air inlet BSP	Max air flow	Hose, 5 m	Coupling	Lubrication	Ordering No.
MIDI Optimizer F/RD EQ10-T13	3/8	35 l/s	Turbo 13 mm	ErgoQIC 10	Yes	8202 0850 17
MIDI Optimizer F/R EQ10-T13	1/2	35 l/s	Turbo 13 mm	ErgoQIC 10	No	8202 0850 04
MIDI Optimizer F/RD EQ10-T13	1/2	35 l/s	Turbo 13 mm	ErgoQIC 10	Yes	8202 0850 13

A worker wearing a blue safety helmet with a clear face shield, a red long-sleeved shirt, and a dark leather apron is focused on a task. They are wearing dark work gloves and using a yellow pneumatic tool with a metal bit to work on a piece of metal. The background shows a workshop environment with various tools and equipment.

Percussive Tools

Contents	Page
Introduction.....	224
Product safety.....	225
Chipping hammers	226
Scalers.....	228
Chisels.....	230
Riveting system	234
Riveting hammers.....	235
Bucking bars.....	237

These tools make light of the toughest jobs

Atlas Copco percussive tools are ideal for all material removal tasks in foundries, engineering workshops, shipyards, and the construction and off-shore industries. Built-in-ergonomic features such as vibration damping reduce the human load, delay fatigue and help protect the operator against the ill effects of long-term exposure to vibration and noise. Vibration-damped models are available over almost the entire power range.

The designs use lightweight alloys to keep tool weight down while maintaining performance.

This makes these tools extremely effective in the hands of your skilled operators.

Weld flux removal

Applications – Fetting welds from flux and spatter. General scaling operations. The tools – Modern welding methods generate slag that is easily removed and almost no spatter. In these applications RVM 07B is the right choice. It has power enough to do the job, very low noise and is vibration damped below 2.5 m/s². The standard chisel delivered with the tool is carbide tipped for a long service life. The tool is also equipped with clean blowing capacity.

For heavy slag chipping and tougher scaling the conventional scaler RRC 13 and RRC 13B with a blowing function are the preferred models. These tools have the right power for this type of job and a sturdy reliable design. The gripping diameter is only 45 mm, including the throttle lever. They also have a low vibration level for conventional models.

Rust and paint removal

Rust and paint removal – Industrial maintenance. Shipyards. On board ships and offshore rigs.

For lighter jobs the needle scaler RRC 13 is the ideal tool. Needle sets of different shapes and material are available to suit most operations.

Chipping

General chipping and multipurpose “chiseling” in heavy industrial use. Fetting of castings in foundries. Offshore and shipyard applications.

Efficient – For highest efficiency, choose tools with a high power-to-weight ratio. RRF 21/31 have an excellent material removal rate.

Well proven design. Simple and well proven design for a long, trouble-free tool life.

The conventional RRC 22 – 75 range models, which have forged steel handles, are basic versions with excellent handling and reliability.

Vibration damped chippers are easy on your operators. The RRF and RRD models are vibration damped.



IMPORTANT: All local safety regulations with respect to installation, operation and overhaul must always be followed.

AVOID ACCIDENTS

1 The chisel, die or punch may fall out or may be shot out of the tool accidentally causing serious injury.

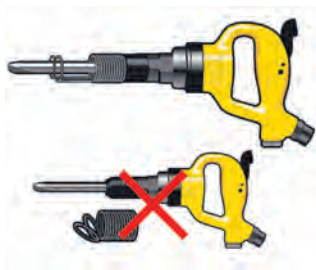

To prevent injury from a flying chisel:

- Always use a retainer.
- Inspect the retainer for wear or damage regularly.



- Be aware that the chisel may break during operation.
- Never trigger a hammer unless held against a work piece.
- Remove chisel, die or punch from tool when work is over.
- When finishing a job, disconnect the tool from its air supply.
- Before changing accessories, chisel or die – disconnect the tool from the air supply.

2 Chips and sparks should be prevented from striking an eye or another worker.



To prevent vision loss:

- Always wear eye protection.
- Isolate work of this kind by using barriers between work stations.
- Do not use the tool for other purposes than it is intended for.

3 Gloves protect fingers from pinching, scuffing and scraping.

- Protective shoes may prevent your feet from being injured.

4 Explosive atmosphere must not be ignited.



To prevent injury and property loss from fires:

- Use other technique.
- Use accessories of non sparking material (e.g. needle attachment of Beryllium copper for a needle scaler).

5 Electric shock may be fatal.

- Avoid chiseling into electric wiring hidden inside walls etc.

LONG TERM RISKS

6 Always use ear protection.



To prevent gradual loss of hearing due to exposure to high noise level – wear ear protection.

7 Vibration may be harmful to hands and arms.



- Use vibration dampened tools if available.
- Reduce the total time of exposure to vibrations, particularly if the operator has to guide the chisel by hand.

8 Dust generated during operation may be harmful.

- Use spot suction or a breathing apparatus.

PROPER USE AND MAINTENANCE

9 Do not perform idle blows with a hammer.



- They will cause high internal stresses and shorten the life of the tool.
- Note the risk of shooting out the chisel, die or punch if the retainer is not in order or damaged.

10 Quick coupling.

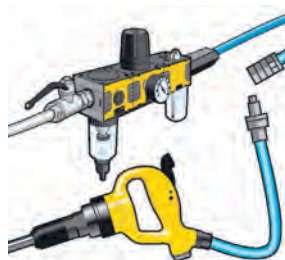

- If a coupling is used on a percussive tool, it should be separated from the tool by a whip hose (length 0.5 m).

11 Follow the tool manual and the lubrication instructions.

12 Perform overhauls at regular intervals.

Chipping Hammers

Vibration-damped and Silenced

- **RRF21/31** have a sturdy D-handle in light metal alloy for a high power-to-weight ratio and steady grip. The compact, vibration-controlled design offers good accessibility and ease of use.
- **RRD37/57** are light, quiet and have a long service life. They have light alloy tool casings, very low vibration and noise levels, vibration damping in both hand grips, and piped away exhaust.



Model	Blows Hz	Piston dia		Stroke		Energy per blow		Length mm	Weight		Bushing		Air consumption		Hose size		Air inlet BSP	Ordering No.
		mm	in	mm	in	J	ft lb		kg	lb	mm	in	l/s	cfm	mm	in		
RRF21-01	57	18	0.7	33	1.3	2.0	1.5	245	1.75	3.3	12.7 ^c	0.50	6.5	13.8	10.0	3/8	3/8	8425 1104 05
RRF31-01	38	22	0.9	43	1.7	4.4	3.2	265	2.5	5.3	12.7 ^c	0.50	7.5	15.9	10.0	3/8	3/8	8425 1104 15
RRD37-11	35	27/19 ^a	1.1/0.8	70	2.8	6.8	5.0	418	3.0	6.6	17.3 ^d	0.68	7.2	15.3	12.5	1/2	special ^e	8425 1101 22
RRD57-11	31	28/18 ^b	1.1/0.8	92	3.6	9.3	6.9	458	3.4	7.5	17.3 ^d	0.68	9.5	20.1	12.5	1/2	special ^e	8425 1103 20
RRD57-12	31	28/18 ^b	1.1/0.8	92	3.6	9.3	6.9	458	3.4	7.5	17.3 ^d	0.68	9.5	20.1	12.5	1/2	special ^e	8425 1103 38

^a Effective piston dia 19 mm, 0.75 in.
^b Effective piston dia 21.5 mm, 0.85 in.
^c ISO.

^d Spline.
^e Integrated hose barb.

-01 and -11: Guided models,
 -02 and -12: Non guided models.

Chipping Hammers

- **Dependable** – Their robust construction makes them highly dependable.
- **Efficient** – RRC65 and RRC75 have a blow rate which makes them particularly suitable for roughening.
- **Chisel retainer** – for safer jobs – RRC22-RRC75 are delivered with a chisel retainer as standard. For the same reason choose a tool that can be guided via the machine itself and not by holding the chisel.

As standard, Atlas Copco chipping hammers of series RRC are delivered with a standard, guided ISO hexagon nozzle (-01) or a round, non guided shank nozzle (-02).



Model	Blows Hz	Piston dia		Stroke		Energy per blow		Length mm	Weight		Bushing		Air consumption		Hose size		Air inlet BSP	Ordering No.
		mm	in	mm	in	J	ft lb		kg	lb	mm	in	l/s	cfm	mm	in		
RRC22F-01	62	15	0.6	52	2.0	2.7	2.0	260	2.2	4.9	12.7 ^a	0.50	6.2	13.1	10	3/8	3/8	8425 0202 22
RRC22F-02	62	15	0.6	52	2.0	2.7	2.0	260	2.2	4.9	12.7 ^a	0.50	6.2	13.1	10	3/8	3/8	8425 0202 30
RRC34B-01	45	24	0.9	67	2.6	5.5	4.1	330	4.5	9.9	17.3 ^a	0.68	8.0	14.0	12.5	1/2	special ^b	8425 0212 53
RRC34B-02	45	24	0.9	67	2.6	5.5	4.1	330	4.5	9.9	17.3 ^a	0.68	8.0	17.0	12.5	1/2	special ^b	8425 0212 61
RRC65B-01	40	29	1.1	50	2.0	10.0	7.3	335	5.9	13.0	17.3 ^a	0.68	10.8	22.9	12.5	1/2	special ^b	8425 0225 33
RRC75B-01	30	29	1.1	75	3.0	16.0	11.8	390	6.5	14.3	17.3 ^a	0.68	14.0	29.6	12.5	1/2	special ^b	8425 0225 58

^a ISO. ^b Integrated hose barb.

Dimensions

Model	L mm	H mm	D mm
RRF21	245	160	33
RRF31	265	170	36
RRD37	418	175	–
RRD57	458	190	–

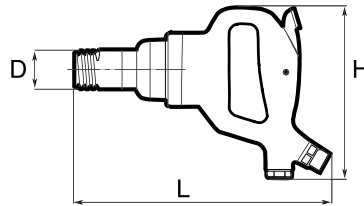

RRF21/31

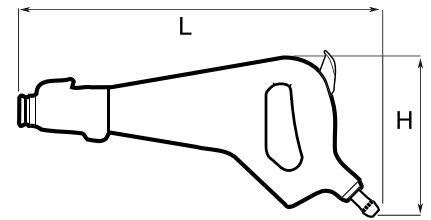

RRD37/57

Model	L mm	H mm	D mm
RRC22	260	155	34
RRC34	330	160	43
RRC65	335	170	54
RRC75	390	170	54

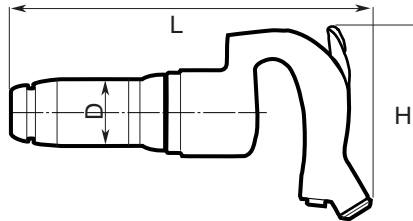

RRC

Accessories Included

RRF models

Chisel retainer and a hose fitting

RRD models

Flat chisel
Silencer complete
Hand grip
Key

RRC models

Chisel retainer and hose fitting

Optional Accessories

Model	Ordering No.
Power regulator	
RRF21 and -31	3512 0273 80
Retainer, open type	
RRF21	3512 0290 90
RRF31	3512 0305 90
Protective handle kit	
RRF21	3512 0349 81
RRF31	3512 0349 82

A selection of chisels for

RRF21/31 ISO 12.7 mm
RRD37/57 ISO with splines

Chisels

For a wide choice of chisels, see separate page.

A selection of chisels fitting RRC -01, -02 type, see separate page for chisels.

Productivity Kits

Model	Max air flow	Hose, 5 m	Coupling	Lubrication	Ordering No.
For percussive tools with 3/8" BSP air inlet incl. whip hose					
MIDI Optimizer F/RD EQ10-R13-W	23 l/s	Rubair 13 mm	ErgoQIC 10	Yes	8202 0850 14
For percussive tools incl whip hose, no tool nipple included					
MIDI Optimizer F/RD EQ10-R13-W	23 l/s	Rubair 13 mm	ErgoQIC 10	Yes	8202 0850 15

Scaler RVM07B is ideal for tasks such as weld dressing, etc.

- **Vibration-damped with low-noise level.**
- **Vibration is very low.**
- **Two-job capacity** – RVM07B features a clean-blowing device (B) which is very useful for clean-blowing work on steel structures etc.
- **RVM07B** is the obvious choice for light concrete trimming and for removal of paint and rust.



RVM07B

Model	Blows Hz	Length mm	Weight incl. standard chisel		Air consumption		Hose size		Air inlet BSP	Ordering No.
			kg	lb	l/s	cfm	mm	in		
RVM07B	100	273	1.7	3.8	3.8	8.1	6.3	1/4	1/4	8425 0105 25

Dimensions

Model	L mm	D mm
RVM07B	273	38

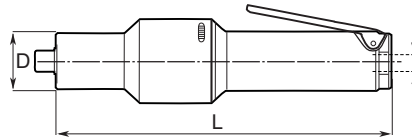

Scalers

Choose between two different models for heavy slag chipping and for instant trimming of concrete.

- **High removal rate** – RRC13 is very effective and has a high removal rate in relation to its low weight.
- **Well proven** percussive mechanism and retainer.
- **Two-job capacity** – RRC13B with extra clean-blowing device.
- **Improved back head** – Throttle valve and lever with really Heavy Duty performance for long service life. Clean blowing system with twice the previous blow



RRC13B

capacity. Big blow button for easy operation and sturdy valve stem to resist rough handling.

Model	Blows Hz	Piston dia		Stroke		Energy per blow		Length mm	Weight		Air consumption		Hose size		Air inlet BSP	Ordering No.
		mm	in	mm	in	J	ft lb		kg	lb	l/s	cfm	mm	in		
RRC13	73	15	0.6	35	1.4	1.4	1.0	221	1.4	3.1	4.0	8.0	10	3/8	3/8	8425 0101 30
RRC13B	73	15	0.6	35	1.4	1.4	1.0	231	1.6	3.5	4.0	8.0	10	3/8	3/8	8425 0101 33

Dimensions

Model	L mm	H mm	D ₁ mm	D ₂ mm
RRC13	221	65	45	41.5
RRC13B	231	65	45	41.5

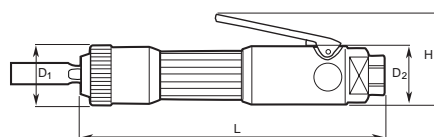

The effective needle scaler, type RRC13N, is based on the same fundamental design as the straight chipping hammers of type RRC13 described above.

- **Sturdy design** – Easy to maintain.
- **Versatile** – The needle scaler is used to remove welding slag, rust and paint from steel structures.



RRC13N

Model	Blows Hz	Piston dia		Stroke		per blow		Length mm	Weight		Energy consumption		Hose size		Air inlet BSP	Air Ordering No.
		mm	in	mm	in	J	ft lb		kg	lb	l/s	cfm	mm	in		
RRC13N	73	15	0.6	35	1.4	1.4	1.0	352	1.9	4.2	4.0	8.0	10	3/8	3/8	8425 0101 36

Dimensions

Model	L ₁ mm	L ₂ mm	D m
RRC13N	282	352	38

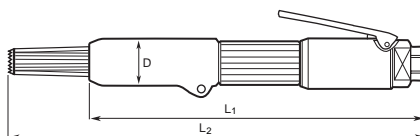

Accessories Included

For all RRC13

Hose fitting
Scaling chisel

For RMV07B

Hose fitting
Flat carbide tipped chisel 10x120 mm

Optional Accessories

For RRC13, 13B

RRC13 / RRC13B	Ordering No.
Hand guard	3510 0246 90
All steel retainer	3510 0245 80
Silencer	3510 0366 80

Chisels for RRC13 and -13B:
Square shank 13.0 mm

For RRC13N

Needle-set of 19 needles, length 100 mm

Material	Ordering No.
Steel, standard	3510 0221 90
Steel flat ends	3510 0227 90
Stainless steel flat ends	3510 0228 90
Beryllium copper flat ends (spark resistant)	3510 0229 90

For RMV07B

Carbide tipped chisels and through hardened chisels with other length and width, see separate page for chisels.

Productivity Kits

Model	Max air flow	Hose	Coupling	Lubrication	Ordering No.
For percussive tools with 3/8" BSP air inlet incl. whip hose					
MIDI Optimizer F/RD EQ10-R13-W	23 l/s	Rubair 13 mm	ErgoQIC 10	Yes	8202 0850 14
For percussive tools incl whip hose, no tool nipple included					
MIDI Optimizer F/RD EQ10-R13-W	23 l/s	Rubair 13 mm	ErgoQIC 10	Yes	8202 0850 15

Chisels for chipping hammers and scalers







Chisels for Chipping hammers. All chisels are normally through hardened. Otherwise, see tables.

Figure	Shank type	Tools	Table
	Square shank 13.0 mm	RRC13, RRC13B	1
	Extended square shank ISO, 12.7 mm	RRC15	1
	Hexagon and round shank ISO, round collar 12.7 mm	RRC22F-01, RRC22F-02 RRF21, RRF31	2
	Hexagon shank ISO round collar 17.3 mm	RRC34B-01, RRC65B-01, RRC75B-01	3
	Round shank ISO, with splines 17.3 mm	RRD37, RRD57	3
	Hexagon shank ISO without round collar 17.3 mm	RRC34-01, RRC65-01, RRC75-01	4
	Round shank ISO, without collar 17.3 mm	RRC34-02, RRC65-02, RRC75-02	4
	Special shank	RVM07B	5



Chisels for chipping hammers and scalers

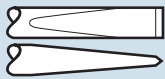

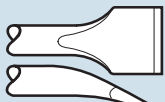
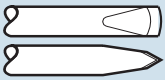



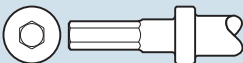

1 A. Chisels with square shank 13.0 mm
B. Chisels with square shank ISO 12.7 mm

Chisel type	Designation	Width		Length		Square 13 mm (1/2") Ordering No.	ISO Extended square 12.7 mm (1/2") Ordering No.
		mm	in	mm	in		
	Chisel blank	15	0.59	155	6.1	3085 0020 00	3085 0228 02
		15	0.59	200	7.9	3085 0020 01	
		15	0.59	300	11.8	3085 0020 02	
	Flat chisel	15	0.59	165	6.1	3085 0227 00	3085 0230 01
		15	0.59	200	7.9	3085 0227 01	
	Wide flat chisel	35	1.38	165	6.5	3085 0032 00	3085 0232 01
		35	1.38	200	7.9	3085 0032 01	
		35	1.38	300	11.8	3085 0032 02	
		55	2.17	165	6.5	3085 0332 00	
	Angle scraper chisel	35	1.38	165	6.5	3085 0176 00	3085 0362 00
		35	1.38	200	7.9	3085 0176 01	
		55	2.17	165	6.5	3085 0333 00	
	Scaling chisel	15	0.59	155	6.1	3085 0018 00	3085 0229 01
		15	0.59	200	7.9	3085 0018 02	
		15	0.59	300	11.8	3085 0018 01	

2 A. Chisels with hexagon shank ISO, round collar 12.7 mm
B. Chisels with round shank ISO, round collar 12.7 mm





Chisel type	Designation	Width		Length		Hex ISO 12.7 mm (1/2") Ordering No.	Round ISO 12.7 mm (1/2") Ordering No.
		mm	in	mm	in		
	Chisel blank	13	0.51	200	7.9	3085 0182 00	
		13	0.51	350	13.8	3085 0182 01	
		13	0.51	400	15.7	3085 0182 04	
		13	0.51	500	19.7	3085 0182 05	
	Flat chisel	13	0.51	200	7.9	3085 0183 00	3085 0184 00
		35	1.38	300	11.8	3085 0376 00	
	Sharp chisel	15	0.59	200	7.9	3085 0170 00	
		15	0.59	300	11.8	3085 0170 01	
	Spot weld chisel	17	0.69	200	7.9	3085 0301 00	
	Angle scraper chisel	30	1.18	200	7.9	3085 0262 00	
	Pipe cutting chisel	20	0.78	200	7.9	3085 0302 00	
		35	1.38	200	7.9	3085 0303 00	
	Plate cutting chisel	14.5	0.57	200	7.9	3085 0263 00	
	Plate cutting chisel	16	0.62	200	7.9	3085 0173 00	
	Moil point chisel	13	0.51	200	7.9	3085 0297 00	
		13	0.51	305	12.0	3085 0297 01	

Chisels for chipping hammers and scalers

3 A. Chisels with hexagon shank ISO, round collar 17.3 mm

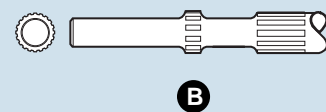
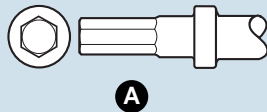
B. Chisels with round ISO shank with splines 17.3 mm



A

B

Chisel type	Designation	Width		Length		Hex ISO 17.3 mm (0.68") Ordering No.	Width		Length		Round ISO with splines 17.3 mm (0.68") Ordering No.
		mm	in	mm	in		mm	in	mm	in	
	Chisel blank	22	0.86	335	13.1	3085 0220 00	22	0.86	250	9.8	3085 0242 00
		22	0.86	560	22.0	3085 0220 01	22	0.86	340	13.4	3085 0242 01
		22	0.86	1060	41.7	3085 0220 02	22	0.86	550	21.7	3085 0242 02
	Flat chisel	22	0.86	260	10.2	3085 0221 00	22	0.86	215	8.5	3085 0236 00
		22	0.86	335	13.1	3085 0221 01	22	0.86	250	9.8	3085 0236 01
		22	0.86	560	41.9	3085 0221 02	22	0.86	340	13.4	3085 0236 02
		22	0.86				22	0.86	550	21.7	3085 0236 03
		22	0.86				22	0.86	800	31.5	3085 0242 03
	Flat chisel	32	1.26	335	13.1	3085 0989 00	32	1.26	340	13.4	3085 0252 00
		32	1.26				32	1.26			
	Wide flat chisel	50	1.97	335	13.1	3085 0235 00	50	1.97	340	13.4	3085 0250 00
		130	5.12	400	15.7	3085 0342 00	130	5.12	400	15.7	3085 0998 00
	Angle scraper chisel	50	1.97	335	13.1	3085 0349 00	50	1.97	335	13.2	3085 0350 00
		50	1.97				50	1.97			
	Moil point chisel	22	0.86	335	13.1	3085 0223 00	22	0.86	340	13.4	3085 0249 00
		22	0.86	560	15.7	3085 0223 01	22	0.86			
	Shank rod for roughing head	-	-	180	7.1	3085 0257 00	-	-	195	7.7	3085 0254 00
	Roughing head for shank rod (tungsten carbide)	39	1.53	-	-	3085 0255 00	39	1.53	-	-	3085 0255 00
	Roughing head for shank rod	40	1.57	-	-	3085 0253 00	40	1.57	-	-	3085 0253 00

4 A. Chisels with ISO shank without collar, round

B. Chisels with ISO shank without collar, hexagon



A

B

Chisel type	Designation	Width		Length		Round 17.3 mm (0.68") ISO Ordering No.	Width		Length		Hexagon 17.3 mm (0.68") ISO Ordering No.
		mm	in	mm	in		mm	in	mm	in	
	Chisel blank	23	0.91	200	7.9	3085 0150 00	23	0.91	200	7.9	3085 0140 00
		23	0.91	560	22.0		23	0.91	560	22.0	
	Flat chisel	23	0.91	225	8.9	3085 0225 00	23	0.91	225	8.9	3085 0224 00
		23	0.91				23	0.91			

Chisels for chipping hammers and scalers

5. Chisels with special shank



Chisel type	Designation	Material	Width		Length		Ordering No.
			mm	in	mm	in	
	Flat chisel	Tungsten carbide	10	0.39	120	4.7	3085 0321 00
		Through hardened steel	10	0.39	120	4.7	3085 0325 00
		Tungsten carbide	10	0.39	200	7.9	3085 0321 01
		Tungsten carbide	10	0.39	300	11.8	3085 0321 02
		Tungsten carbide	20	0.79	120	4.7	3085 0345 00
		Through hardened steel	20	0.79	120	4.9	3085 0346 00
	Wide chisel	Tungsten carbide	35	1.38	120	4.7	3085 0322 00
		Through hardened steel	35	1.38	120	4.7	3085 0327 00

Minimum vibration, maximum productivity

Atlas Copco's top-of-the-line riveting systems are designed to minimize the riveter's exposure to vibration, while maintaining high tool performance. The RRH recoilless riveting hammer has an air cushion behind the hammer piston which efficiently kills vibrations. The same air dampening technique is used in RBB bucking bars. It raises individual productivity and boosts output in your plant.

The Atlas Copco riveting system includes vibration-damped hammers RRH and bucking bars RBB – as well as conventional riveting hammers RRN.

The vibration-damped riveting hammers – RRH – are available in different sizes.

Each size is available in "Trigger start" and "Push to start" models.

The conventional riveting hammer – RRN – is available in one size: RRN11P.

Critical factors

The number of blows and the power are critical factors which determine the strength of a riveted joint. A few powerful blows are needed to fill out the hole and form a head when upsetting the rivet. The impact force is critical to some extent when working with aluminum alloys, as too many blows can embrittle the metal.

In terms of capacity, the tools overlap. The selection guide below helps you to find the right tool for your particular application of riveting.

The vibration-damped bucking bars RBB are available in two versions – the simple spring damped – SP type and the air servo assisted SA type.



Selection Guide

Hammer model ^a	Nominal Max. Rivet Diameter Capacity						Bucking bar model required ^b	
	Dural		Steel		Titanium			
	mm	in	mm	in	mm	in		
RRN11	2-5	3/32 - 3/16	1-4	3/32 - 5/32				
RRH04	2-5	3/32 - 3/16	1-4	3/21 - 5/32			RBB04	RBB10
RRH06	4-7	5/32 - 1/4	3-6	1/8 - 1/4	2-4	3/32 - 5/32	RBB10	RBB16
RRH08	5-8	3/16 - 5/16	4-7	5/32 - 1/4	3-6	1/8 - 1/4	RBB10	RBB16
RRH10	5-9	3/16 - 3/8	6-8	1/4 - 5/16	4-7	5/32 - 1/4	RBB16	
RRH12	8-11	5/16 - 7/16	7-10	1/4 - 3/8	6-9	1/4 - 3/8	RBB16	
RRH14	11-13	7/16 - 1/2	9-12	3/8 - 15/32	8-11	5/16 - 7/16	RBB16	

^a Hammer capacity depends on direct/indirect riveting as well as Panel density and stiffness.

^b Bucking bar capacity is dependent on dolly weight.

RRH is a unique series of riveting hammers incorporating completely revolutionary ergonomic advantages.

- **Versatile** – RRH can easily cope with rivets in diameters up to 13 mm.
- **Vibration-damped system** – The RRH vibration-damped riveting hammer, combined with the RBB vibration-damped bucking bar, offer an unbeatable system for riveting.
- **Adjustable power.**
- **Adjustable hand guard** – Support hand grip is vibration-damped.
- Now new models with trigger start for excellent handling. Pistol grip with rubber coating.



Model	Blows Hz	Nozzle		Piston dia		Stroke		Energy per blow		Weight		Air consumption		Hose size		Air inlet BSP	Ordering No.
		mm	in	mm	in	mm	in	J	ft lb	kg	lb	l/s	cfm	mm	in		
With push start																	
RRH04P-01	66	10.0	0.4	15	0.6	40	1.6	2.0	1.5	1.0	2.2	3.7	6	6.3	1/4	1/4	8426 1111 07
RRH04P-02	66	10.2	0.4	15	0.6	40	1.6	2.0	1.5	1.0	2.2	3.7	6	6.3	1/4	1/4	8426 1111 15
RRH04P-12	66	10.2	0.4	15	0.6	40	1.6	2.0	1.5	1.0	2.2	3.7	6	6.3	1/4	1/4	8426 1111 25
RRH06P	36	10.2	0.4	15	0.6	102	4.0	6.0	4.4	1.3	2.9	9.0	19	10.0	3/8	1/4	8426 1111 04
RRH08P	24	10.2	0.4	15	0.6	137	5.4	8.0	5.9	1.4	3.0	10.0	21	10.0	3/8	1/4	8426 1111 09
RRH10P	25	12.7	0.5	19	0.7	118	4.6	13.0	9.6	2.0	4.4	12.0	24	10.0	3/8	1/4	8426 1110 20
RRH12P	20	12.7	0.5	19	0.7	153	6.0	16.0	11.8	2.1	4.6	13.0	28	10.0	3/8	1/4	8426 1110 47
RRH14P	18	12.7	0.5	19	0.7	188	7.4	19.5	14.4	2.2	4.8	13.0	28	10.0	3/8	1/4	8426 1110 80
With trigger start																	
RRH04P TS-12	66	10.2	0.4	15	0.6	40	1.6	2.0	1.5	1.0	2.2	3.7	6	6.3	1/4	1/4	8426 1111 27
RRH06P TS	36	10.2	0.4	15	0.6	102	4.0	6.0	4.4	1.3	2.9	9.0	19	10.0	3/8	1/4	8426 1111 66
RRH08P TS	24	10.2	0.4	15	0.6	137	5.4	8.0	5.9	1.4	3.0	10.0	21	10.0	3/8	1/4	8426 1111 68
RRH10P TS	25	12.7	0.5	19	0.7	118	4.6	13.0	9.6	2.0	4.4	12.0	24	10.0	3/8	1/4	8426 1110 70
RRH12P TS	20	12.7	0.5	19	0.7	153	6.0	16.0	11.8	2.1	4.6	13.0	28	10.0	3/8	1/4	8426 1110 72
RRH14P TS	18	12.7	0.5	19	0.7	188	7.4	19.5	14.4	2.2	4.8	13.0	28	10.0	3/8	1/4	8426 1110 81

-01 means 10 mm short shank rivet set.

-02 means 10.2 mm short shank rivet set.

-12 means 10.2 mm stand shank rivet set.

Conventional Type

Riveting Hammers

For riveting in confined spaces we recommend our RRN11 riveting hammer.

- **RRN11** – is the smallest riveting hammer available on the market, with unique accessibility.
- **Adjustable** – The RRN11 has a built-in adjustment knob with which you can set the power for different rivet materials and sizes.
- **Controllable** – The trigger is easily operated and provides excellent control.



Model	Blows Hz	Nozzle		Piston dia		Stroke		Energy per blow		Weight		Air consumption		Hose size		Air inlet BSP	Ordering No.
		mm	in	mm	in	mm	in	J	ft lb	kg	lb	l/s	cfm	mm	in		
RRN11P-01	66	10.0	0.4	15	0.6	40	1.6	2.0	1.5	1.2	2.6	3.4	7.2	6.3	1/4	1/8	8426 1101 05
RRN11P-02	66	10.2	0.4	15	0.6	40	1.6	2.0	1.5	1.2	2.6	3.4	7.2	6.3	1/4	1/8	8426 1101 13

-01 means 10 mm short shank rivet set.

-02 means 10.2 mm short shank rivet set.

Dimensions

Model	L mm	H mm	C mm
RRH			
RRH04-01	160	147	23
RRH04-02	160	147	23
RRH04-12	175	147	23
RRH06	225	147	24
RRH08P	244	147	24
RRH10P	264	150	27
RRH12P	299	150	27
RRH14P	334	150	27
RRN			
RRN11P	100	170	23

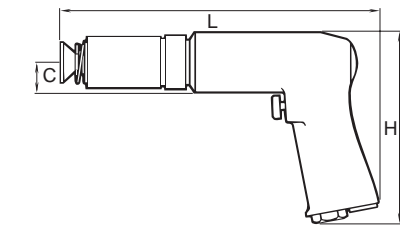

RRH

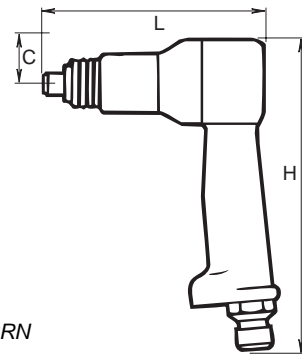

RRN

Accessories Included

For RRH models

Hose fitting
Flush set
Open spring retainer

For RRN11P

Hose fitting and retainer
Blank rivet set
Retainers for blank and flush rivet set

Optional Accessories

Rivet sets. RRH and RRN

Hammer type	Model	Shank mm		Flush set Ordering No.		Blank rivet set Ordering No.
RRH04P-01 RRN11P-01	(-01)	10.0 spec		3085 0347 00		3006 0983 00
RRH04P-02 RRN11P-02	(-02)	10.2 spec		3085 0352 00		3085 0353 00
RRH04P-12 RRH06P RRH08P	(-12)	10.2 std		3085 0324 00		3085 0022 00
RRH10P RRH12P RRH14P		12.7 std		3085 0323 00		3085 0021 00
RRH04P-12 RRH06P RRH08P		10.2 std				3085 0212 00
RRH04P-12 RRH06P RRH08P		10.2 std				3085 0212 02

An efficient riveting system consists of vibration-damped bucking bars together with vibration-damped riveting hammers.

- Self-adjustable** – RBB10SA and RBB16SA feature a self-adjusting damping system which requires a compressed air supply. RBB04SP, RBB10SP and RBB16SP use a spring as damping element and consequently do not require an air supply.
- Flexible** – The bucking bars can be fitted with several different interchangeable dolly configurations via a quick change retainer for maximum flexibility.
- Cramped spaces** – Mini bucking bars RBB04SP are ideal for work in confined spaces. The large mass types -04, -05 will in most applications set the rivet faster than the smaller models.

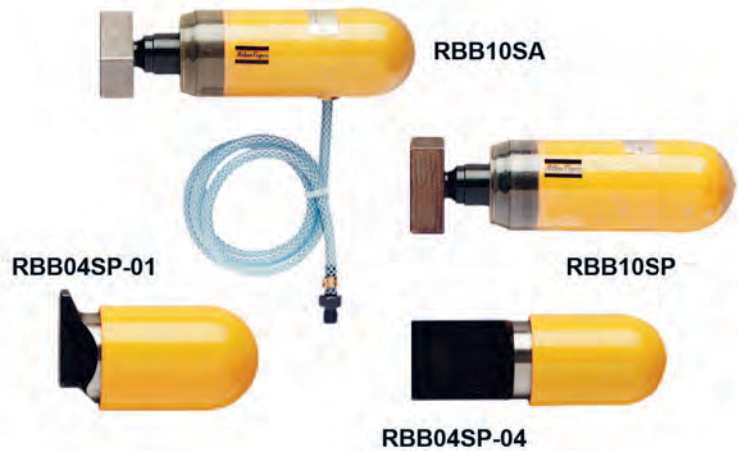

Model	Weight		Diameter		Air consumption		Ordering No.
	kg	lb	mm	in	l/s	cfm	
With standard dolly^a							
RBB10SA	1.3	2.9	48	2.0	0.5	1.1	8426 9101 77
RBB10SP	1.1	2.4	48	2.0	–	–	8426 9101 74
RBB16SA	1.9	4.2	48	2.0	0.5	1.1	8426 9101 78
RBB16SP	1.7	3.7	48	2.0	–	–	8426 9101 76
Mini bucking bars							
RBB04SP-01	0.8	1.8	46	1.8	–	–	8426 9101 10
RBB04SP-04	1.3	2.9	46	1.8	–	–	8426 9101 13
RBB04SP-05	1.4	3.1	46	1.8	–	–	8426 9101 14
RBB04SP-06	1.1	2.5	46	1.8	–	–	8426 9101 15

^a Standard dolly assy (3085 0335 93).

Accessories Included

- All SA-models**
Hose and hose fitting
- All 10/16 models**
Plastic cover

Optional Accessories

Designation	Ordering No.
Rod 5 mm	3085 0365 03
Rod 50 mm	3085 0365 04
Rod 100 mm	3085 0365 05
Plastic cover for	
RBB10SA	3520 0317 00
RBB10SP	3520 0315 00
RBB16SA	3520 0318 00
RBB16SP	3520 0316 00

Dimensions

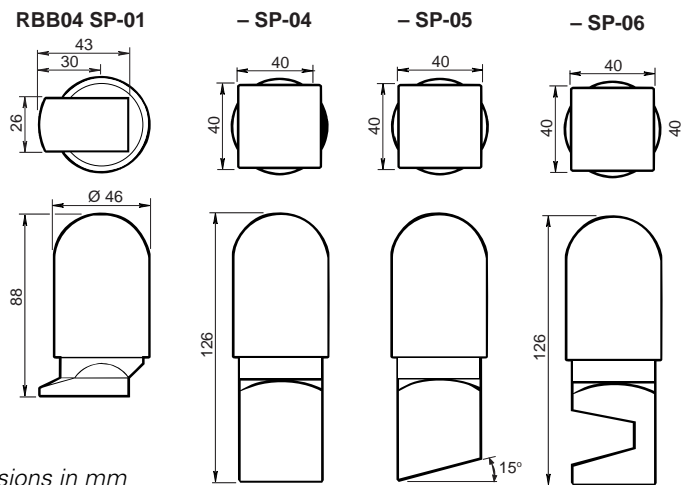

Dimensions in mm

Dimensions RBB10/16

Model	L mm	H mm	C mm
RBB10SA/SP	165	49	140
RBB16SA/SP	200	49	198

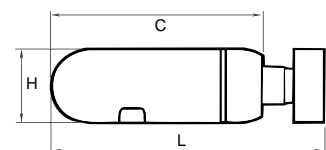

Optional Accessories

Dollies for RBB10 and RBB16, all models

Dolly type	Weight		Ordering No. With rod 5 mm	Weight		Ordering No. With rod 50 mm	Weight		Ordering No. With rod 100 mm
	kg	lb		kg	lb		kg	lb	
A	0.37	0.8	3085 0335 93 ^a	0.47	1.0	3085 0335 94	0.67	1.5	3085 0335 95
B	0.25	0.55	3085 0363 93	0.35	0.8	3085 0363 94	0.55	1.3	3085 0363 95
C	0.36	0.8	3085 0364 93	0.46	1.0	3085 0364 94	0.66	1.5	3085 0364 95
D	0.43	0.9	3085 0337 93	0.53	1.2	3085 0337 94	0.73	1.6	3085 0337 95
E	0.35	0.8	3085 0339 93	0.45	1.0	3085 0339 94	0.65	1.5	3085 0339 95
F	0.57	1.3	3085 0336 93	0.67	1.5	3085 0336 94	0.87	1.9	3085 0336 95
G	1.00	2.2	3085 0338 93	1.10	2.4	3085 0338 94	1.30	2.9	3085 0338 95
H	0.62	1.4	3085 0340 93	0.72	1.6	3085 0340 94	0.92	2.0	3085 0340 95
J	0.62	1.4	3085 0341 93	0.72	1.6	3085 0341 94	0.92	2.0	3085 0341 95

^a Standard dolly assy.

Other dollies can also be used, apart from Atlas Copco's, and press fitted onto a rod. Please see rod (i.e. hole) specification in the below drawing. Custom design dollies are recommended to be manufactured locally and fitted on to Atlas Copco rods.

DIMENSIONAL DRAWING of dollies available

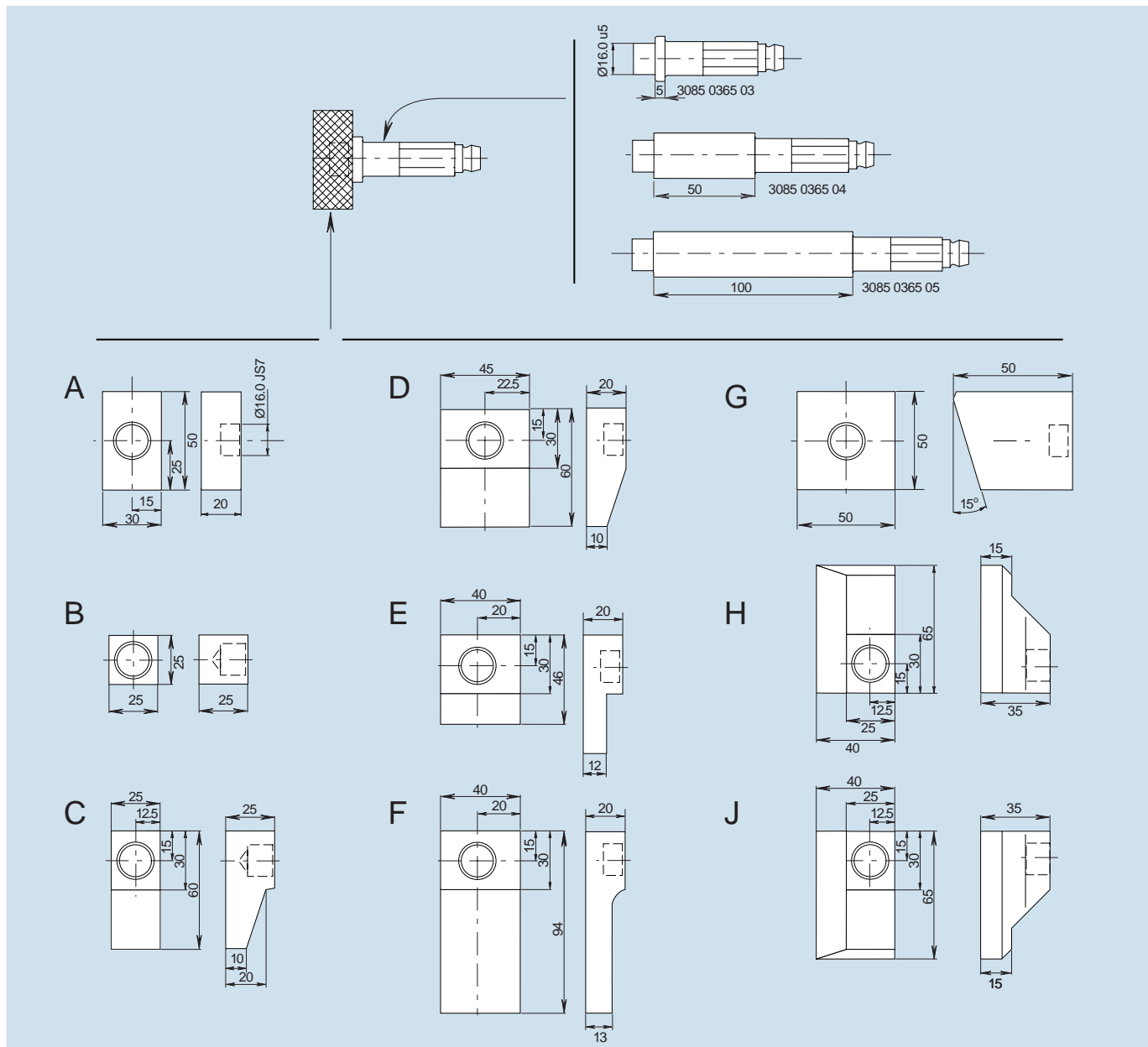

Drills



Contents	Page
Introduction.....	240
Pistol grip drills	242
Straight drills.....	246
Angle drills	248
Modular drills	252
Micro stop drills.....	254
Tappers.....	256
Screw-feed drills	258
Power feed drills.....	259

Reliable, productive and comfortable to work with

The handheld drills in Atlas Copco's wide range are of the highest quality and built to provide consistent reliability and performance in a wide range of applications. Their advanced ergonomic designs make your job easier, safer and more efficient.

From the time our first drill was produced in 1901, Atlas Copco has demonstrated a genuine understanding of customer needs. Our drills have evolved to meet changing customer demands over the years. Whatever the job, Atlas Copco has a drill to match your exact requirements.

Reliable

When you pick up an Atlas Copco drill, you can be confident that it will do the job over and over again.

Powerfully productive

Despite their compact designs, our drills consistently deliver all the power you need. Their high power-to-weight ratio ensures maximum material removal in the shortest possible time.

Ergonomic

Thanks to 50 years of focusing on ergonomics, Atlas Copco drills fit comfortably in your hand. Grips are anatomically shaped to keep your arm and wrist straight, reducing the risk of injury during long-term use. The light weight and perfect balance of each drill enables you to guide it smoothly and easily. Low noise and vibration levels make the tools comfortable to work with all day long.

Durable, low maintenance

The rugged, lubrication-free designs of our drills can withstand the toughest industrial situations and go on working day in, day out. Maintenance requirements are low.

Quality throughout the tools' life-cycle

Atlas Copco stands for quality, from the manufacture of critical drill components, through production and sales, to service and support throughout the tools' long life-cycle.



Regardless of which model you choose, you'll get a product with superior ergonomics and productivity.

- Quiet – Very low noise level.
- Comfortable grip – For high precision.
- Two-hand grip available – Gives even greater flexibility.
- Lubrication-free – For clean working environment and operator comfort.



Model	Free speed r/min	Chuck capacity mm	Weight with chuck		Air consumption at free speed		Hose size		Air inlet thread BSP	Power		With chuck Ordering No.	Without chuck	
			kg	lb	l/s	cfm	mm	in		W	hp		Model	Ordering No.
Non-reversible drills with air supply through handle														
LBB16 EP-003 ^b	300	10	0.7	1.5	8.0	17.0	6.3	1/4	1/4	290	0.4	8421 0108 01	003-U	8421 0108 02
LBB16 EP-005 ^b	500	10	0.7	1.5	8.0	17.0	6.3	1/4	1/4	290	0.4	8421 0108 06	005-U	8421 0108 07
LBB16 EP-010	1000	10	0.7	1.5	8.0	17.0	6.3	1/4	1/4	290	0.4	8421 0108 10	010-U	8421 0108 11
LBB16 EP-024 ^a	2400	6.5	0.6	1.2	8.0	17.0	6.3	1/4	1/4	290	0.4	8421 0108 20	024-U	8421 0108 21
LBB16 EP-033 ^a	3300	6.5	0.6	1.2	8.0	17.0	6.3	1/4	1/4	290	0.4	8421 0108 30	033-U	8421 0108 31
LBB16 EP-045 ^a	4500	6.5	0.6	1.2	8.0	17.0	6.3	1/4	1/4	290	0.4	8421 0108 40	045-U	8421 0108 41
LBB16 EP-060 ^a	6000	6.5	0.6	1.2	8.0	17.0	6.3	1/4	1/4	290	0.4	8421 0108 50	060-U	8421 0108 51
LBB16 EP-200 ^a	20000	6.5	0.6	1.2	8.0	17.0	6.3	1/4	1/4	290	0.4	8421 0108 60	200-U	8421 0108 61
LBB16 EPX-005 ^b	500	13	0.7	1.5	9.5	20.0	6.3	1/4	1/4	340	0.45	8421 0108 08	005-U	8421 0108 09
LBB16 EPX-010 ^b	1000	10	0.7	1.5	9.5	20	6.3	1/4	1/4	340	0.45	8421 0108 12	010-U	8421 0108 03
LBB16 EPX-024 ^a	2400	6.5	0.6	1.2	9.5	20.0	6.3	1/4	1/4	340	0.45	8421 0108 22	024-U	8421 0108 23
LBB16 EPX-033 ^a	3300	6.5	0.6	1.2	9.5	20.0	6.3	1/4	1/4	340	0.45	8421 0108 32	033-U	8421 0108 33
LBB16 EPX-045 ^a	4500	6.5	0.6	1.2	9.5	20.0	6.3	1/4	1/4	340	0.45	8421 0108 42	045-U	8421 0108 43
LBB16 EPX-060 ^a	6000	6.5	0.6	1.2	9.5	20.0	6.3	1/4	1/4	340	0.45	8421 0108 52	060-U	8421 0108 53
LBB16 EPX-200 ^a	20000	6.5	0.6	1.2	9.5	20	6.3	1/4	1/4	340	0.45	8421 0108 82	200-U	8421 0108 63
LBB26 EPX-003 ^b	300	13	0.82	1.8	14.5	31.8	10.0	3/8	1/4	500	0.7	8421 0500 00	003-U	8421 0500 01
LBB26 EPX-005 ^b	500	13	0.82	1.8	14.5	31.8	10.0	3/8	1/4	500	0.7	8421 0500 02	005-U	8421 0500 03
LBB26 EPX-007 ^b	700	13	0.82	1.8	14.5	31.8	10.0	3/8	1/4	500	0.7	8421 0500 04	007-U	8421 0500 05
LBB26 EPX-013 ^{ab}	1300	10	0.79	1.7	14.5	31.8	10.0	3/8	1/4	500	0.7	8421 0500 06	013-U	8421 0500 07
LBB26 EPX-019 ^a	1900	10	0.79	1.7	14.5	31.8	10.0	3/8	1/4	500	0.7	8421 0500 24	019-U	8421 0500 25
LBB26 EPX-026 ^a	2600	8	0.79	1.7	14.5	31.8	10.0	3/8	1/4	500	0.7	8421 0500 08	026-U	8421 0500 09
LBB26 EPX-033 ^a	3300	8	0.69	1.5	14.5	31.8	10.0	3/8	1/4	500	0.7	8421 0500 10	033-U	8421 0500 11
LBB26 EPX-045 ^a	4500	8	0.69	1.5	14.5	31.8	10.0	3/8	1/4	500	0.7	8421 0500 12	045-U	8421 0500 13
LBB26 EPX-060 ^a	6000	8	0.69	1.5	14.5	31.8	10.0	3/8	1/4	500	0.7	8421 0500 14	060-U	8421 0500 15
LBB36 H005 ^b	500	–	1.2	3.3	16.5	34.9	10	3/8	3/8	700	0.9	–	-H005U	8421 0408 03
LBB36 H007 ^b	700	13	1.6	3.5	16.5	34.9	10	3/8	3/8	700	0.9	8421 0408 07	-H007U	8421 0408 05
LBB36 H013 ^a	1300	10	1.5	3.3	16.5	34.9	10.0	3/8	3/8	700	0.9	8421 0408 15	-H013U	8421 0408 13
LBB36 H026 ^a	2600	10	1.2	2.5	16.5	34.9	10.0	3/8	3/8	700	0.9	8421 0408 33	-H026U	8421 0408 31
LBB36 H033 ^a	3300	10	1.2	2.5	16.5	34.9	10.0	3/8	3/8	700	0.9	8421 0408 41	-H033U	8421 0408 39
LBB36 H060 ^a	6000	6.5	1.2	2.5	16.5	34.9	10.0	3/8	3/8	700	0.9	8421 0408 49	-H060U	8421 0408 47
LBB36 H200 ^a	20000	6.5	1.0	2.2	16.5	34.9	10.0	3/8	3/8	700	0.9	8421 0408 55	-H200U	8421 0408 53
LBB37 H006	600	13	1.2	2.5	20.5	44.0	10.0	3/8	3/8	820	1.1	8421 0608 06	-H006U	8421 0608 14
LBB37 H015	1500	10	1.5	3.3	20.5	44.0	10.0	3/8	3/8	820	1.1	8421 0608 05	-H015U	8421 0608 15
LBB37 H037	3700	10	1.2	2.5	20.5	44.0	10.0	3/8	3/8	820	1.1	8421 0608 13	-H037U	8421 0608 16
LBB37 H065	6500	6.5	1.2	2.5	20.5	44.0	10.0	3/8	3/8	820	1.1	8421 0608 11	-H065U	8421 0608 17
LBB37 H230	23000	6.5	1.0	2.2	20.5	44.0	10.0	3/8	3/8	820	1.1	8421 0608 03	-H230U	8421 0608 18
LBB45 H004 ^b	400	16	4.3	9.3	10.0	21.0	10.0	3/8	1/4	700	0.9	8421 0501 16	–	–
LBB45 H006 ^b	600	16	4.3	9.3	10.0	21.0	10.0	3/8	1/4	700	0.9	8421 0501 24	-H006U	8421 0501 40
LBB45 H017 ^b	1700	16	4.2	9.3	10.0	21.0	10.0	3/8	1/4	700	0.9	8421 0501 32	–	–
ATEX certified models														
LBB26 EPX005-ATEX 500		13	0.82	1.8	14.5	31.8	10	3/8	1/4	500	0.7	8421 0500 22	–	–
LBB26 EPX007-ATEX 700		13	0.82	1.8	14.5	31.8	10	3/8	1/4	500	0.7	8421 0500 21	–	–
LBB26 EPX013-ATEX1300		10	0.79	1.7	14.5	31.8	10	3/8	1/4	500	0.7	8421 0500 20	–	–
LBB26 EPX026-ATEX2600		8	0.79	1.7	14.5	31.8	10	3/8	1/4	500	0.7	8421 0500 19	–	–

^a Including chuck guard.

^b Including support handle.

Dimensions

LBB EP/EPX/H

Model	L mm	H mm	C mm	D mm	E mm
LBB16 EP/EPX-200	177	131	16.5	31.4	13.8
LBB16 EP/EPX-060	177	131	16.5	31.4	13.8
LBB16 EP/EPX-045	177	131	16.5	31.4	13.8
LBB16 EP/EPX-033	177	131	16.5	31.4	13.8
LBB16 EP/EPX-024	177	131	16.5	31.4	13.8
LBB16 EP/EPX-010	190	131	16.5	31.4	27.0
LBB16 EP/EPX-005	190	131	16.5	31.4	27.0
LBB16 EP-003	190	131	16.5	31.4	27.0
LBB26 EPX-060	180	147	21	39	-
LBB26 EPX-045	180	147	21	39	-
LBB26 EPX-033	180	147	21	39	-
LBB26 EPX-026	180	147	21	39	-
LBB26 EPX-019	196	147	21	39	-
LBB26 EPX-013	196	147	21	39	-
LBB26 EPX-007	196	147	21	39	-
LBB26 EPX-005	196	147	21	39	-
LBB26 EPX-003	196	147	21	39	-
LBB36 H200	217	157	23	41.5	16.5
LBB36 H060	217	157	23	41.5	16.5
LBB36 H033	217	157	23	41.5	16.5
LBB36 H026	217	157	23	41.5	16.5
LBB36 H013	256	157	23	41.5	64.0
LBB36 H007	256	157	23	41.5	64.0
LBB36 H005	256	157	23	41.5	64.0
LBB37 H230	217	157	23	41.5	16.5
LBB37 H065	217	157	23	41.5	16.5
LBB37 H037	217	157	23	41.5	16.5
LBB37 H015	256	157	23	41.5	64.0
LBB37 H006	256	157	23	41.5	64.0
LBB45 H006	360	185	33	60	113
LBB45 H017	360	185	33	60	113
LBB45 H004	360	185	33	60	113

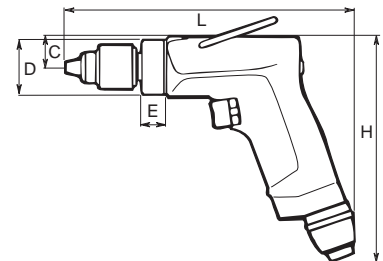

Accessories Included

Chuck, chuck key, hose nipple.

LBB16 and -36/37 with suspension yoke and with chuck guard where possible.

LBB16 and -36/37 have a 3/8" -24 UNF spindle thread.

LBB36 H005 and LBB37 H006 have a 1/2" -20 UNF thread.

LBB45 has a JT3 taper mount.

Optional Accessories

Quick chucks

Mount	Chuck dia mm	Chuck capacity mm	Ordering No.
3/8-24UNF	34	0.0- 6.5	4021 0400 00
3/8-24UNF	34	0.0- 8.0	4021 0401 00
3/8-24UNF	36	0.0-10.0	4021 0402 00
3/8-24UNF	36	2.0-13.0	4021 0403 00



Quick chuck

Support handles

For model	Ordering No.
LBB16	4110 1355 92
LBB26	4110 1355 95
LBB36/37	4110 1355 82
LBB45	4110 1355 84



Support handle

Optional Accessories

Collet chuck and collets

Designation	Capacity		Ordering No.	
	mm	in		
Collet	3		4150 0081 00	
	6		4150 0075 00	
	8	5/16		4150 0074 00
		1/8		4150 0082 00
		5/32		4150 0648 00
		3/16		4150 0649 00
		1/4		4150 0076 00
Collet holder			4110 0844 90	
Collet nut			4150 0760 00	



Collet chuck and collets

Flex connect

For model	Ordering No.
LBB16	4110 1601 80



Flex connect

Spot suction attachment

For model	Hose size in	Spot suction kit ^a Ordering No.	Hose kit Ordering No.
LBB16	1 1/4	4110 1715 80	4112 1227 00
LBB26	1 1/4	4110 1715 84	4112 1227 00
LBB36/37	1 1/4	4110 1716 80	4112 1227 00



Spot suction attachment

^a Spare part, nose piece kit, Ordering No. 4110 1700 90.
Other standard sizes of front nozzle available.

Power feed arm for extra feed force – LBB36 H005 and LBB37 H006

	Ordering No.
Adapter piece (SR295), lever arm (SR201), chain (SR202) and No. 2 Morse socket (SR206)	4110 1416 80
Two extension pieces (SR204-1 and SR204-2), 370 and 750 mm long	4110 1417 80
No. 2 Morse socket	4110 1416 01



Power feed arm

Chuck guards

For model	Max chuck dia mm	Ordering No.
LBB16 ^a	30	4110 1619 04
LBB26	36	4110 1728 02
LBB26	30	4110 1728 03
LBB36 ^b	36	4110 1415 00
LBB37 ^b	36	4110 1415 00

^a The guards do not fit 1000 r/min models, 500 r/min and 300 r/min models.

^b The chuck guards do not fit the 500 r/min, 600 r/min or 700 r/min models.



Chuck guard

Key chucks

Mount	Body diameter mm	Chuck capacity mm	Ordering No.		
			Chuck (key incl)	Key only	Key designation
1/2-20UNF	43	2.0-13.0	4021 0289 01	4021 0465 00	S2
3/8-24UNF	30	0.0- 6.5	4021 0283 00	4021 0293 00	S1
3/8-24UNF	30	0.5- 8.0	4021 0495 00	4021 0293 00	S1
3/8-24UNF	36	2.0-10.0	4021 0416 00	4021 0449 00	S8
3/8-24UNF	46	2.0-13.0	4021 0289 00	4021 0465 00	S2
JT3	59	3.0-16.0	4021 0423 00	4021 0301 00	S3



Key chuck

Optional accessories – LBB45

Designation	Ordering No.
Feed screw	4110 0976 80
No. 2 Morse socket	4130 1080 00

Productivity Kits

Model	Max air flow	Hose, 5m	Coupling	Lubrication	Ordering No.
For small drills with 1/8" BSP air inlet					
MIDI Optimizer F/RD EQ08-C06-1/8	6 l/s	Cablair 6 mm	ErgoQIC 08	Yes	8202 0850 10
MIDI Optimizer F/R EQ08-C06-1/8	6 l/s	Cablair 6 mm	ErgoQIC 08	No	8202 0850 19
For small drills with 1/4" BSP air inlet					
MIDI Optimizer F/RD EQ08-C06	6 l/s	Cablair 6 mm	ErgoQIC 08	Yes	8202 0850 06
For drills with 1/4" BSP air inlet					
MIDI Optimizer F/RD EQ08-C08	9 l/s	Cablair 8 mm	ErgoQIC 08	Yes	8202 0850 00
MIDI Optimizer F/R EQ08-C08	9 l/s	Cablair 8 mm	ErgoQIC 08	No	8202 0850 01
For drills with 3/8" BSP air inlet					
MIDI Optimizer F/RD EQ08-C10	16 l/s	Cablair 10 mm	ErgoQIC 08	Yes	8202 0850 07
For drills with 3/8" BSP air inlet					
MIDI Optimizer F/RD EQ10-C13	23 l/s	Cablair 13 mm	ErgoQIC 10	Yes	8202 0850 02
For drills with 1/4" BSP air inlet					
MIDI Optimizer F/RD EQ10-C13-1/4	23 l/s	Cablair 13 mm	ErgoQIC 10	Yes	8202 0850 11



Service Kits

LBB16	4081 0271 90
LBB26	4081 2028 90
LGB/LBV34	4081 0035 90
LBB36/37	4081 0194 90
LBB45	4081 0139 90

Atlas Copco straight drills are primarily intended for vertical drilling operations and for drilling in cramped spaces.

- Quiet – Very low noise level.
- Very high power to weight ratio.
- Adjustable exhaust – The exhaust air is directed away from the operator.
- Lubrication-free – LBB16 drills are lubrication-free for clean working environment and operator comfort.



LBB16

Model	Free speed ^a r/min	Chuck capacity mm	Weight		Air consumption at free speed		Hose size		Air inlet thread BSP	Power		With chuck Ordering No.	Without chuck	
			kg	lb	l/s	cfm	mm	in		W	hp		Model	Ordering No.
Drills with rear exhaust														
LBB16 S260	26000	6.5	0.55	1.1	8.0	17	6.3	1/4	1/4	350	0.47	8421 0210 00	S260-U	8421 0210 10
LBB16 S064	6400	6.5	0.55	1.1	8.0	17	6.3	1/4	1/4	350	0.47	8421 0210 01	S064-U	8421 0210 11
LBB16 S045	4500	6.5	0.55	1.1	8.0	17	6.3	1/4	1/4	350	0.47	8421 0210 02	S045-U	8421 0210 12
LBB16 S038	3800	6.5	0.55	1.1	8.0	17	6.3	1/4	1/4	350	0.47	8421 0210 03	S038-U	8421 0210 13
LBB16 S029	2900	8	0.60	1.2	8.0	17	6.3	1/4	1/4	350	0.47	8421 0210 04	S029-U	8421 0210 14
LBB16 S022	2200	10	0.70	1.5	8.0	17	6.3	1/4	1/4	350	0.47	8421 0210 05	S022-U	8421 0210 15
LBB16 S012	1200	10	0.70	1.5	8.0	17	6.3	1/4	1/4	350	0.47	8421 0210 06	S012-U	8421 0210 16

^a The free speed can be reduced to 50% of the maximum speed using the trim valve.

Dimensions

Model	L	H	A
LBB16 S260	196	39	146
LBB16 S064	196	39	146
LBB16 S045	196	39	146
LBB16 S038	196	39	146
LBB16 S029	196	39	146
LBB16 S022	219	39	159
LBB16 S012	219	39	159

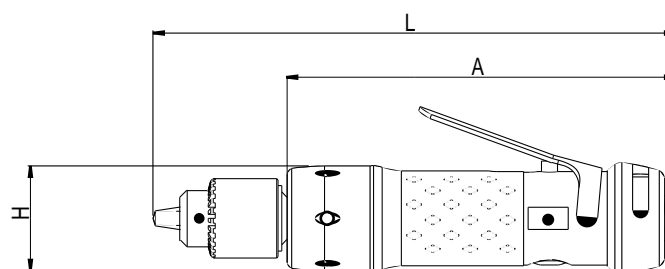

Accessories Included

Chuck, chuck key
Suspension yoke and chuck guard

Optional Accessories

Key chucks

Mount	Body diameter mm	Chuck capacity mm	Ordering No.		
			Chuck (key incl)	Key only	Key designation
1/2-20UNF	43	2.0-13.0	4021 0289 01	4021 0465 00	S2
3/8-24UNF	30	0.0- 6.5	4021 0283 00	4021 0293 00	S1
3/8-24UNF	30	0.5- 8.0	4021 0495 00	4021 0293 00	S1
3/8-24UNF	36	2.0-10.0	4021 0416 00	4021 0449 00	S8
3/8-24UNF	46	2.0-13.0	4021 0289 00	4021 0465 00	S2
JT3	59	3.0-16.0	4021 0423 00	4021 0301 00	S3



Key chuck

Quick chucks

Mount	Chuck dia mm	Chuck capacity mm	Ordering No.
3/8-24UNF	34	0.0- 6.5	4021 0400 00
3/8-24UNF	34	0.0- 8.0	4021 0401 00
3/8-24UNF	36	0.0-10.0	4021 0402 00
3/8-24UNF	36	2.0-13.0	4021 0403 00



Quick chuck

Collet chuck and collets

Designation	Capacity		Ordering No.
	mm	in	
Collet	3		4150 0081 00
	6		4150 0075 00
	8	5/16	4150 0074 00
		1/8	4150 0082 00
		5/32	4150 0648 00
		3/16	4150 0649 00
		1/4	4150 0076 00
	Collet holder		
Collet nut			4150 0760 00



Collet chuck and collets

Push button set

For model	Ordering No.
LBB16S	4110 1679 90



Push button set

Safety lever

For model	Ordering No.
LBB16S	4110 1787 80



Safety lever



Service Kits

LBB16 4081 0438 90

- Quiet – Very low noise level.
- Low air consumption – Good operating economy.
- Side exhaust – The air can be directed to suit the operator.
- Rear exhaust – The air is piped away through a pliant hose.
- Lubrication-free – For clean working environment and operator comfort.
- Collet chuck or threaded spindle.
- Multiple lever options.



Model	Free speed r/min	Setting range rpm	Collet or chuck capacity mm	Weight		Air consumption at free speed		Hose dimension mm	Air inlet thread		Power		Ordering No.
				kg	lb	l/s	cfm		in	BSP	W	hp	
30° angle head													
LBV11 S027-S30	2900	–	5	0.5	1.1	4.0	8.5	5.0	1/8	1/8	110	0.16	8421 0108 70
LBV16 032-30	3200	1500-3200	5	0.5	1.1	8.7	18.4	6.3	1/4	1/4	300	0.4	8421 0110 05
LBV16 032-S30	3200	1500-3200	5	0.45	1.0	8.7	18.4	6.3	1/4	1/4	300	0.4	8421 0110 04
LBV16 032-32	3200	1500-3200	°	0.5	1.1	8.7	18.4	6.3	1/4	1/4	300	0.4	8421 0110 07
LBV16 032-S32	3200	1500-3200	°	0.45	1.0	8.7	18.4	6.3	1/4	1/4	300	0.4	8421 0110 06
LBV36 S030-30 ^e	3000	–	5	1.0	2.2	17.0	36.0	10.0	3/8	1/4	510	0.73	8421 0414 70
45° angle head													
LBV16 032-45	3200	1500-3200	5	0.5	1.1	8.7	18.4	6.3	1/4	1/4	300	0.4	8421 0110 59
LBV16 032-46	3200	1500-3200	°	0.5	1.1	8.7	18.4	6.3	1/4	1/4	300	0.4	8421 0110 60
90° angle head													
LBV11 S025-S90	2900	–	5	0.5	1.1	4.0	8.5	5.0	1/8	1/8	110	0.16	8421 0109 79
LBV16 032-90	3200	1500-3200	5	0.5	1.1	8.7	18.4	6.3	1/4	1/4	300	0.4	8421 0110 00
LBV16 032-S90	3200	1500-3200	5	0.45	1.0	8.7	18.4	6.3	1/4	1/4	300	0.4	8421 0110 01
LBV16 032-92	3200	1500-3200	°	0.5	1.1	8.7	18.4	6.3	1/4	1/4	300	0.4	8421 0110 03
LBV16 032-S92	3200	1500-3200	°	0.45	1.0	8.7	18.4	6.3	1/4	1/4	300	0.4	8421 0110 02
LBV16 045-90	4500	3200-4500	5	0.5	1.1	8.7	18.4	6.3	1/4	1/4	300	0.4	8421 0110 20
LBV16 045-92	4500	3200-4500	°	0.5	1.1	8.7	18.4	6.3	1/4	1/4	300	0.4	8421 0110 21
LBV16 055-90	5500	4500-5500	5	0.5	1.1	8.7	18.4	6.3	1/4	1/4	300	0.4	8421 0110 23
LBV16 055-92	5500	4500-5500	°	0.5	1.1	8.7	18.4	6.3	1/4	1/4	300	0.4	8421 0110 24
LBV16 055-S92	5500	4500-5500	°	0.45	1.0	8.7	18.4	6.3	1/4	1/4	300	0.4	8421 0110 58
LBV36 S030-90 ^e	3000	–	5	1.0	2.2	17.0	36.0	10.0	3/8	1/4	510	0.73	8421 0414 60
LBV36 S030-S90 ^e	3000	–	5	0.9	2.0	17.0	36.0	10.0	3/8	1/4	510	0.73	8421 0414 61
LBV36 S030-92 ^e	3000	–	°	1.0	2.2	17.0	36.0	10.0	3/8	1/4	510	0.73	8421 0414 64
LBV36 S030-S92 ^e	3000	–	°	0.9	2.0	17.0	36.0	10.0	3/8	1/4	510	0.73	8421 0414 65
LBV36 S045-90 ^e	4500	–	5	1.0	2.2	17.0	36.0	10.0	3/8	1/4	510	0.73	8421 0414 62
LBV36 S045-S90 ^e	4500	–	5	0.9	2.0	17.0	36.0	10.0	3/8	1/4	510	0.73	8421 0414 63
360° angle head													
LBV16 032-90Z	3200	1500-3200	5	0.5	1.1	8.7	18.4	6.3	1/4	1/4	300	0.4	8421 0110 64
LBV16 032-92Z	3200	1500-3200	°	0.5	1.1	8.7	18.4	6.3	1/4	1/4	300	0.4	8421 0110 68
90° angle head – large angle head													
LBV16 005-91	500	200-500	6.6	0.6	1.2	8.7	18.4	6.3	1/4	1/4	300	0.4	8421 0110 11
LBV16 005-93	500	200-500	°	0.6	1.2	8.7	18.4	6.3	1/4	1/4	300	0.4	8421 0110 12
LBV16 010-91	1000	500-1000	6.6	0.6	1.2	8.7	18.4	6.3	1/4	1/4	300	0.4	8421 0110 16
LBV16 010-93	1000	500-1000	°	0.6	1.2	8.7	18.4	6.3	1/4	1/4	300	0.4	8421 0110 17
LBV16 018-91	1800	800-1800	6.6	0.55	1.2	8.7	18.4	6.3	1/4	1/4	300	0.4	8421 0110 18
LBV16 018-93	1800	800-1800	°	0.55	1.2	8.7	18.4	6.3	1/4	1/4	300	0.4	8421 0110 19
LBV16 032-91	3200	1500-3200	6.6	0.55	1.2	8.7	18.4	6.3	1/4	1/4	300	0.4	8421 0110 09
LBV16 032-93	3200	1500-3200	°	0.55	1.2	8.7	18.4	6.3	1/4	1/4	300	0.4	8421 0110 10
LBV16 032-S93	3200	1500-3200	°	0.45	1.2	8.7	18.4	6.3	1/4	1/4	300	0.4	8421 0110 39
LBV16 045-91	4500	3200-4500	6.6	0.55	1.2	8.7	18.4	6.3	1/4	1/4	300	0.4	8421 0110 38
LBV36 S030-91 ^e	3000	–	6.6	1.0	2.2	17.0	36.0	10.0	3/8	1/4	510	0.73	8421 0414 50
LBV36 S060-91 ^e	6000	–	6.6	1.0	2.2	17.0	36.0	10.0	3/8	1/4	510	0.73	8421 0414 51
LBV36 S030-93 ^e	3000	–	°	1.0	2.2	17.0	36.0	10.0	3/8	1/4	510	0.73	8421 0414 52
LBV36 S060-93 ^e	6000	–	°	1.0	2.2	17.0	36.0	10.0	3/8	1/4	510	0.73	8421 0414 53

Model	Free speed r/min	Setting range rpm	Collet or chuck capacity mm	Weight		Air consumption at free speed		Hose dimension mm	Air inlet thread		Power		Ordering No.
				kg	lb	l/s	cfm		in	BSP	W	hp	
90° angle head – Key chuck models													
LBV16 018-11	1800	800-1800	6.5 ^a	0.8	1.7	8.7	18.4	6.3	1/4	1/4	110	0.4	8421 0110 22
LBV34 S005 ^b	500	–	13 ^a	2.1	4.6	7.5	15.9	10.0	3/8	1/4	400	0.6	8421 0309 04
LBV34 S010 ^b	1000	–	10 ^a	2.0	4.4	7.5	15.9	10.0	3/8	1/4	400	0.6	8421 0309 12
LBV34 S040 ^b	4000	–	6.5 ^a	1.5	3.3	7.5	15.9	10.0	3/8	1/4	400	0.6	8421 0309 46
90° angle head – heavy-duty													
LBV37 030	3000	–	^c	1.1	2.4	22	46	10.0	3/8	3/8	820	1.1	8421 0414 54
LBV37 055	5500	–	^c	1.1	2.4	22	46	10.0	3/8	3/8	820	1.1	8421 0414 55
LBV37 HD030	3000	–	^d	1.1	2.4	22	46	10.0	3/8	3/8	820	1.1	8421 0414 56
LBV37 HD055	5500	–	^d	1.1	2.4	22	46	10.0	3/8	3/8	820	1.1	8421 0414 57

^a Spindle thread, male 3/8"-24 UNF.

^b Side exhaust.

^c Internal thread 1/4"-28.

^d Internal thread 5/16".

^e Short lever as standard.

Dimensions

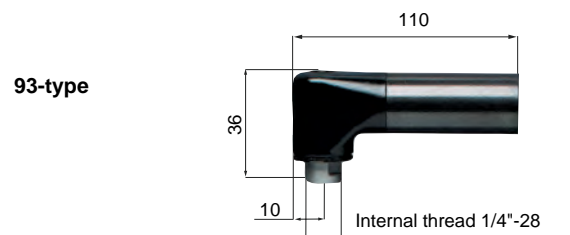
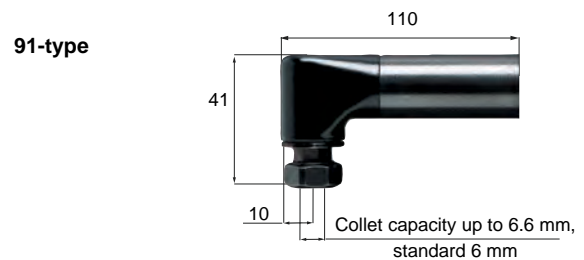
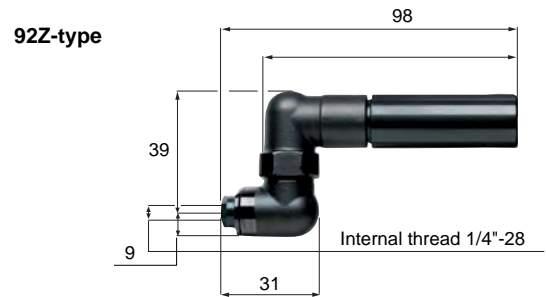
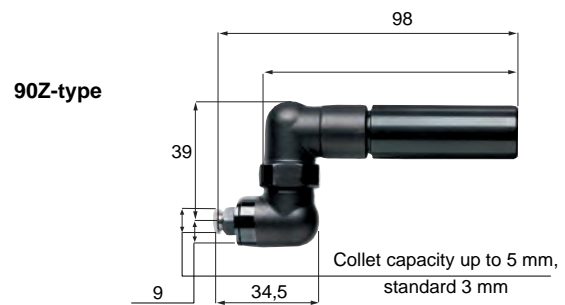
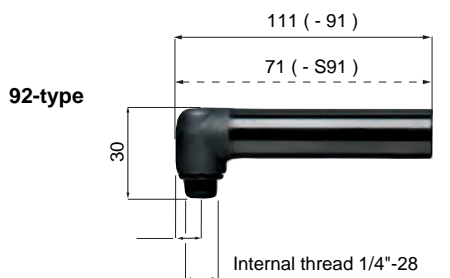
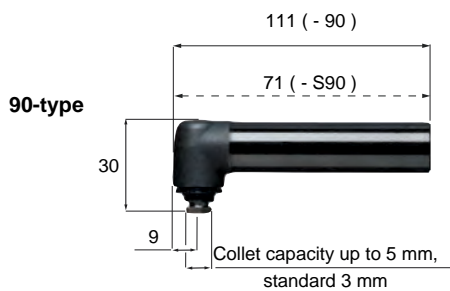
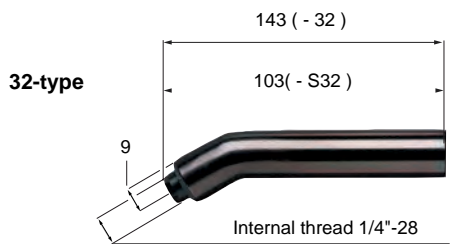
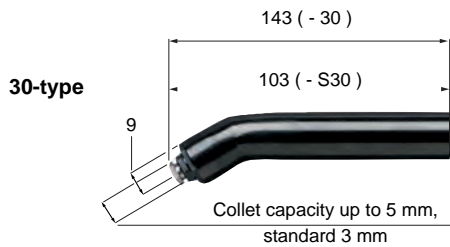

Dimensions

Drilling capacity

Model	Angle head mm				
	A	B	C	L	H
LBV11 S027-S30	59	25	18	224	30
LBV11 S025-S90	44	30	18	204	30
LBV16 032-S30	103	25	17	241	42
LBV16 032-30	143	25	17	281	42
LBV16 032-S32	103	25	17	241	42
LBV16 032-32	143	25	17	281	42
LBV16 032-90	111	30	17	248	42
LBV16 032-S90	71	30	17	209	42
LBV16 032-S92	71	30	17	209	42
LBV16 032-92	111	30	17	249	42
LBV16 032-90Z	145	48	17	283	42
LBV16 032-91	110	39	20	248	42
LBV16 032-93	110	36	20	248	42
LBV16 005-91	110	39	20	248	42
LBV16 005-93	110	36	20	248	42
LBV16 010-91	110	39	20	248	42
LBV16 010-93	110	36	20	248	42
LBV16 018-91	110	39	20	248	42
LBV16 018-93	110	36	20	248	42
LBV34 S040	92	97	20	255	43
LBV34 S010	92	114	20	290	43
LBV34 S005	92	120	20	290	43
LBV36 S030-91	92	41	20	252	43
LBV36 S060-91	92	41	20	252	43
LBV36 S030-93	92	36	20	252	43
LBV36 S060-93	92	36	20	252	43
LBV36 S030-30	122	26	18	281	43
LBV36 S045-30	122	26	18	281	43
LBV36 S030-90	112	30	18	272	43
LBV36 S030-S90	72	30	18	232	43
LBV36 S045-90	112	30	18	272	43
LBV36 S045-S90	72	30	18	232	43
LBV36 S030-92	112	30	18	272	43
LBV36 S030-S92	72	30	18	232	43
LBV37 030	55	39	23	262	43
LBV37 055	55	39	23	262	43
LBV37 HD030	55	39	23	262	43
LBV37 HD055	55	39	23	262	43

LBV11, -16, -36
30°

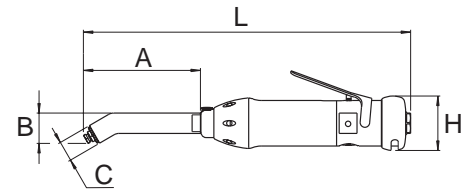

LBV11, -16, -36
90°

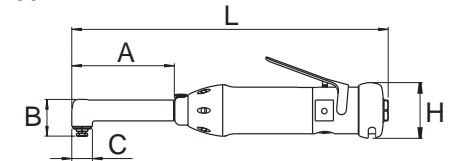

LBV16, -25
360°

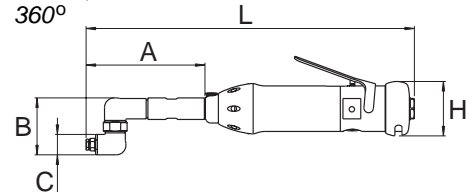

LBV34
90°

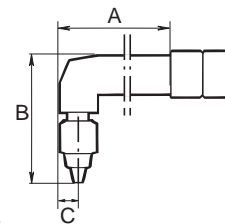

LBV37
90°

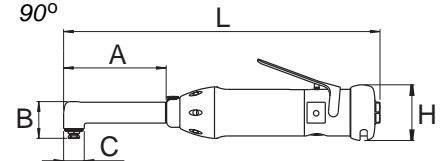

Accessories Included

Key wrenches

Collet or chuck with key
3 mm collet (5.0 collet capacity head)
6 mm collet (6.6 collet capacity head)

Optional Accessories

Safety levers

For model	Ordering No.
LBV16	4110 1787 80
LBV36/37	4150 1594 97



Safety lever

Push button set

For model	Ordering No.
LBV16	4110 1679 90



Push button set

Short levers

For model	Ordering No.
LBV16	4210 2306 04



Short lever

Collets for 5.0 mm capacity head LBV11, LBV16 – (-30, -90, -90Z) and LBV36 (-30, -90)

Capacity mm	Ordering No.	Capacity mm	Ordering No.	Capacity in	Ordering No.
1.0	4110 0438 01	3.4	4110 0438 33	1/16	4110 0438 19
1.5	4110 0438 02	3.5	4110 0438 13	3/32	4110 0438 20
1.8	4110 0438 28	3.6	4110 0438 24	1/8	4110 0438 21
2.0	4110 0438 03	3.7	4110 0438 34	5/32	4110 0438 22
2.1	4110 0438 29	3.8	4110 0438 14	3/16	4110 0438 23
2.2	4110 0438 04	3.9	4110 0438 35		
2.3	4110 0438 30	4.0	4110 0438 15		
2.4	4110 0438 05	4.1	4110 0438 25		
2.5	4110 0438 06	4.2	4110 0438 26		
2.6	4110 0438 07	4.3	4110 0438 36		
2.7	4110 0438 31	4.4	4110 0438 37		
2.8	4110 0438 32	4.5	4110 0438 16		
2.9	4110 0438 08	4.6	4110 0438 38		
3.0	4110 0438 09	4.7	4110 0438 39		
3.1	4110 0438 10	4.8	4110 0438 18		
3.2	4110 0438 11	4.9	4110 0438 40		
3.3	4110 0438 12	5.0	4110 0438 27		

Collets for 5.0 mm (Thread BSF 9/32 -40)

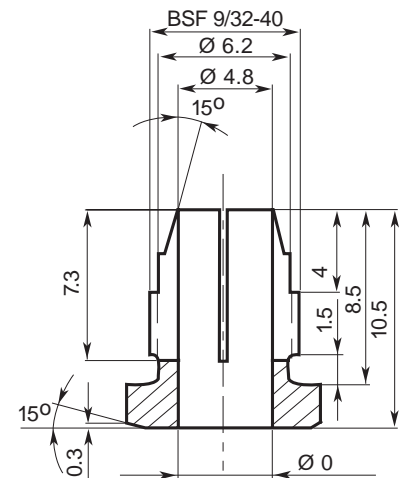

Collets for 6.6 mm capacity head LBV16 (-91) and LBV36 (-91)

Capacity mm	Ordering No.	Capacity mm	Ordering No.
1.6	4110 1411 01	4.2	4110 1411 14
1.8	4110 1411 02	4.4	4110 1411 15
2.0	4110 1411 03	4.6	4110 1411 16
2.2	4110 1411 04	4.8	4110 1411 17
2.4	4110 1411 05	5.0	4110 1411 18
2.6	4110 1411 06	5.2	4110 1411 19
2.8	4110 1411 07	5.4	4110 1411 20
3.0	4110 1411 08	5.6	4110 1411 21
3.2	4110 1411 09	5.8	4110 1411 22
3.4	4110 1411 10	6.0	4110 1411 23
3.6	4110 1411 11	6.2	4110 1411 24
3.8	4110 1411 12	6.4	4110 1411 25
4.0	4110 1411 13	6.6	4110 1411 26

Collets for 6.6 mm

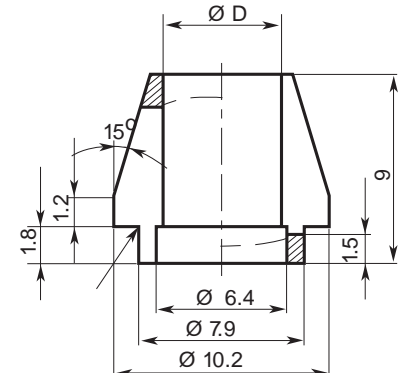

Collet nut 4110 1410 00, to be ordered separately.



Service Kits

LBV16	4081 0322 90
LBV24	4081 0005 90
LBV25	4081 0272 90
LGB/LBV34	4081 0035 90
LBV36 (30, 90/92)	4081 0263 90
LBV36 (91/93)	4081 0251 90
LBV37	4081 0251 90

The LBV16M is designed with the operator in focus. A lightweight tool with a powerful air motor combined with interchangeable angle heads equals excellent flexibility in any handheld drilling operation. Swap to a new head in a matter of seconds with the easy-to-use quick change mechanism. With the LBV16M you are always ready to take on any job in ever changing drilling applications.

- Quick change system – Easy-to-use and robust quick change design for high durability.
- Indexable head – The head can be positioned in any direction for maximum accessibility.
- High power lubrication free motor – No more oil aerosols, for a safer and cleaner working environment.



LBV16M 032/045/055



LBV16M 005/010/018

Model	Free speed ^a rpm	Motor speed ^b	Weight		Air consumption		Hose size		Air inlet thread BSP	Ordering No.
			kg	lb	l/s	cfm	mm	in		
Motor units										
LBV16M 005	500	600	0.57	1.25	8.7	18.4	6.3	1/4	1/4	8421 0120 60
LBV16M 010	1000	1200	0.57	1.25	8.7	18.4	6.3	1/4	1/4	8421 0120 50
LBV16M 018	1800	2100	0.57	1.25	8.7	18.4	6.3	1/4	1/4	8421 0120 40
LBV16M 032	3200	3600	0.45	1	8.7	18.4	6.3	1/4	1/4	8421 0120 00
LBV16M 045	4500	5100	0.45	1	8.7	18.4	6.3	1/4	1/4	8421 0120 10
LBV16M 055	5500	6200	0.45	1	8.7	18.4	6.3	1/4	1/4	8421 0120 30

^a The free speed is given when used with a 90° angle head.

^b Multiply this value with the Speed ratio to get the free speed of each angle head.

Model	Angle head	Weight		Collet capacity	Thread in	Speed ratio	Ordering No.
		kg	lb				
Angle heads with collet							
LBV16M AH90	90°	0.17	0.36	5.0	-	14:16	8421 0121 00
LBV16M AH45	45°	0.17	0.36	5.0	-	14:15	8421 0121 10
LBV16M AH30	30°	0.17	0.36	5.0	-	14:15	8421 0121 20
LBV16M AH90Z	360°	0.17	0.36	5.0	-	7:9	8421 0121 30
LBV16M AH91	90°	0.17	0.36	6.6	-	14:16	8421 0121 05
Angle head with internal thread							
LBV16M AH92	90°	0.17	0.36	-	1/4"-28	14:16	8421 0121 01
LBV16M AH46	45°	0.17	0.36	-	1/4"-28	14:15	8421 0121 11
LBV16M AH32	30°	0.17	0.36	-	1/4"-28	14:15	8421 0121 21
LBV16M AH92Z	360°	0.17	0.36	-	1/4"-28	7:9	8421 0121 31
LBV16M AH93	90°	0.17	0.36	-	1/4"-28	14:16	8421 0121 06
Straight head for chuck							
LBV16M AHS	Straight	0.11	0.25	-	3/8"-24	1:1	8421 0121 40



LBV16M AH90/92



LBV16M AH45/46



LBV16M AH30/32



LBV16M AH90Z/92Z



LBV16M AHS

Optional Accessories

Safety levers

For model	Ordering No.
LBV16M	4110 1787 80



Safety lever

Push button set

For model	Ordering No.
LBV16M	4110 1679 90



Push button set

Short levers

For model	Ordering No.
LBV16M	4210 2306 04



Short lever

Collets for 5.0 mm capacity angle head LBV16M AH(-30, -45, -90, -90Z)

Capacity mm	Ordering No.	Capacity mm	Ordering No.	Capacity in	Ordering No.
1.0	4110 0438 01	3.4	4110 0438 33	1/16	4110 0438 19
1.5	4110 0438 02	3.5	4110 0438 13	3/32	4110 0438 20
1.8	4110 0438 28	3.6	4110 0438 24	1/8	4110 0438 21
2.0	4110 0438 03	3.7	4110 0438 34	5/32	4110 0438 22
2.1	4110 0438 29	3.8	4110 0438 14	3/16	4110 0438 23
2.2	4110 0438 04	3.9	4110 0438 35		
2.3	4110 0438 30	4.0	4110 0438 15		
2.4	4110 0438 05	4.1	4110 0438 25		
2.5	4110 0438 06	4.2	4110 0438 26		
2.6	4110 0438 07	4.3	4110 0438 36		
2.7	4110 0438 31	4.4	4110 0438 37		
2.8	4110 0438 32	4.5	4110 0438 16		
2.9	4110 0438 08	4.6	4110 0438 38		
3.0	4110 0438 09	4.7	4110 0438 39		
3.1	4110 0438 10	4.8	4110 0438 18		
3.2	4110 0438 11	4.9	4110 0438 40		
3.3	4110 0438 12	5.0	4110 0438 27		

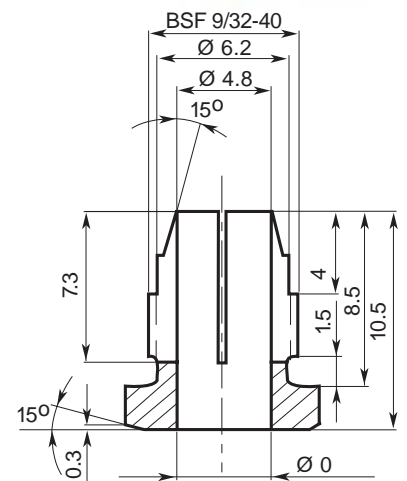

Collets for 5.0 mm (Thread BSF 9/32 -40)

Collets for 6.6 mm capacity angle head LBV16M AH91

Capacity mm	Ordering No.	Capacity mm	Ordering No.
1.6	4110 1411 01	4.2	4110 1411 14
1.8	4110 1411 02	4.4	4110 1411 15
2.0	4110 1411 03	4.6	4110 1411 16
2.2	4110 1411 04	4.8	4110 1411 17
2.4	4110 1411 05	5.0	4110 1411 18
2.6	4110 1411 06	5.2	4110 1411 19
2.8	4110 1411 07	5.4	4110 1411 20
3.0	4110 1411 08	5.6	4110 1411 21
3.2	4110 1411 09	5.8	4110 1411 22
3.4	4110 1411 10	6.0	4110 1411 23
3.6	4110 1411 11	6.2	4110 1411 24
3.8	4110 1411 12	6.4	4110 1411 25
4.0	4110 1411 13	6.6	4110 1411 26

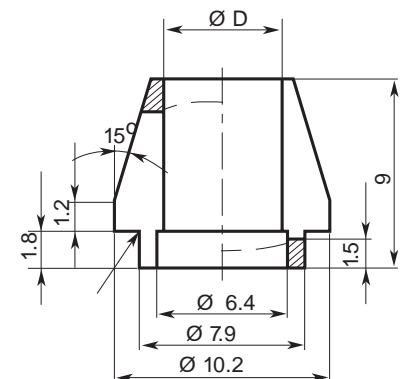

Collets for 6.6 mm

Collet nut 4110 1410 00, to be ordered separately.



Service Kits

LBV16M

4081 0322 90

The Atlas Copco LBS36 drill is equipped with an integrated micro stop. It is designed for the aerospace industry where the focus is on high-precision drilling, reaming and countersinking.

- **Accurate** – The integrated micro stop function makes the LBS36 unique for high-precision drilling of rivet holes and other fasteners. Minimized spindle run-out is achieved by eliminating standard drill chuck.
- **Ergonomic handle design** – The integrated micro stop function makes the tool shorter and lighter in weight.
- **Flexible** – Can be used for drilling, reaming, countersinking and, in certain applications, a combined operation using a form bit.
- **Dust extraction** – Equipped with a specially designed spot suction system for working in composite materials.
- **Lubrication-free** – For clean working environment and operator comfort.



LBS36

Model	Free speed r/min	Spindle thread in/mm	Stroke		Setting range ±		Weight		Hose size		Air consumption		Air inlet thread BSP	Ordering No.
			mm	in	mm	in	kg	lb	mm	in	l/s	cfm		
LBS36 H033-40	3300	1/4"-28	40	1.6	6	1/4	1.2	2.6	10	3/8	16.5	34.9	3/8	8421 0220 80
LBS36 H013-40	1300	1/4"-28	40	1.6	6	1/4	1.5	3.3	10	3/8	16.5	34.9	3/8	8421 0220 90

Dimensions

Model	L mm	H mm	C mm
LBS36 H033-40	281	157	21
LBS36 H013-40	314	157	21

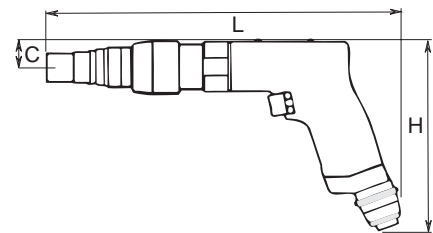

Accessories Included

Hose nipple
2x2 mm Allen wrenches

Optional Accessories

Designation		Attachment	Ordering No.
Plain base, dia 24 mm	Fig 1	M 20x1	4110 1521 00
Plain base for nylon ring (attached with thread M35x1)	Fig 2	M 20x1	4110 1522 00
Separate nylon ring for above base, outer dia 40 mm, thread M35x1	Fig 3	M 20x1	4110 1523 00
Plain base, dia 14.5 mm	Fig 4	M 20x1	4110 1520 00
Tripod, nylon supported	Fig 5	Dia 22 mm	4110 1524 00
Spot suction attachment for drilling in composite, to be used in combination with plain base, dia 24 mm			4110 1529 90

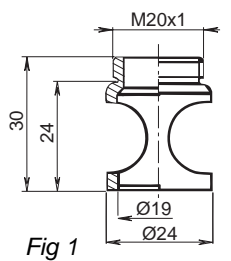

Fig 1

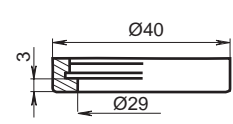

Fig 3

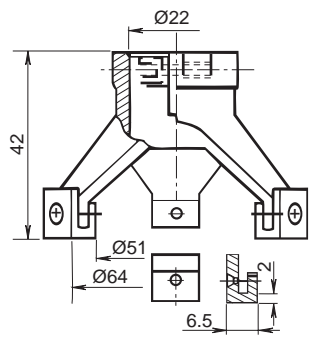

Fig 5

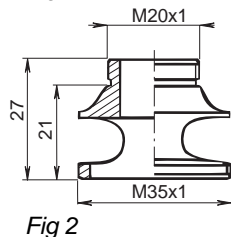

Fig 2

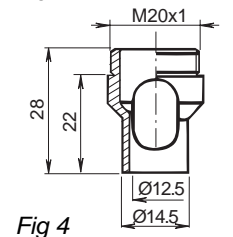

Fig 4



Service Kits

LBS 4081 0005 90

Atlas Copco tappers are designed for tapping and thread-cleaning operations with thread taps. The tools are fitted with a tap chuck as standard.

- Comfortable and effective – The ergonomically designed handle gives a comfortable grip and maximum performance.
- Higher productivity – Double speed when you withdraw the machine.
- Low noise level – Rear-directed exhaust gives a lower noise level.
- Lubrication-free – For a clean working environment and operator comfort.
- Quick change system – Upgrade your old tool, or order a new one with this system. Various tap holders can be used to change a broken tap or to change to a different tap size.
- Lower cost – The efficient air motor, together with interchangeable components from our standard drills, cut your costs.



Model	Free speed		Tapping capacity mm	Weight		Hose dimension		Air inlet thread BSP	Air consumption		With chuck Ordering No.	Without chuck	
	Forward r/min	Reverse r/min		kg	lb	mm	in		l/s	cfm		Model	Ordering No.
Pistol-grip tappers with air supply through handle													
LGB34 H007	700	1400	10	1.8	4.0	10.0	3/8	1/4	7.5	15.9	8421 0311 66	-U	8421 0311 68
LGB34 H007Q ^a	700	1400	10	1.8	4.0	10.0	3/8	1/4	7.5	15.9	8421 0311 76	-	-
LGB36 H007Q ^a	700	1400	12	2.0	4.4	10.0	3/8	3/8	16.5	34.9	8421 0411 00	-	-
Straight tappers													
LGB34 S007	700	1400	10	1.8	4.0	10.0	3/8	1/4	7.5	15.9	8421 0311 72	-U	8421 0311 74

^a Quick change system.
Taper: Jacob 1

Dimensions

Model	L mm	H mm	C mm
LGB34 H007	300	156	20
LGB34 S007	293	43	21
LGB36 H007	335	157	20

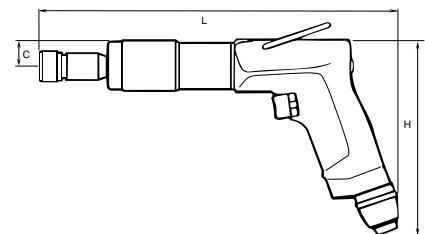

Accessories Included

Non Quick change system

LGB34 Chuck complete with collet 6.4-10 mm 4021 0469 00

Quick change system

Chuck plus one tap holder with collet for M6 shank Ø 6.3 mm.

Optional Accessories

Collets for non Quick change system

Model	Capacity mm	Ordering No.
LGB34	3.5- 6.5	4021 0337 00
	4.5- 8.0	4021 0336 00
	6.4-10.0	4021 0456 00

Collets for Quick change system

Collets for tap size mm	Shank dia mm	Ordering No.
M2.2/M2.5	2.8	4021 0414 01
M3	3.15	4021 0414 02
M3.5	3.5	4021 0414 03
M4	4.0	4021 0414 04
M4.5	4.5	4021 0414 05
M5	5.0	4021 0414 06
M5.5	5.6	4021 0414 07
M6	6.4	4021 0414 08
M6 (DIN)	6.0	4021 0414 13
M7	7.1	4021 0414 09
M8/M11	8.0	4021 0414 10
M9/M12	9.0	4021 0414 11
M10	10.0	4021 0414 12

Completing existing equipment with Quick change system

Accessories	Length mm	Ordering No.
Quick change chuck	47	4021 0406 90
Tap holder	58	4021 0408 00



Service Kits

LGB34 4081 0035 90
LGB36 4081 0194 90

Atlas Copco screw-feed drills are ideal for heavy-duty drilling operations requiring high feed forces. They can also be used for reaming and tube-rolling.

- **Reliable** – Simple, reliable design.
- **Constant speed** – The speed governor keeps the drilling speed constant and reduces air consumption as power is reduced.
- **Safer** – The safety catch prevents accidental starting. The throttle is also self-closing.



Model	Forward	Reverse
RAB9	0.85 kW (1.14 hp)	0.55 kW (0.74 hp)
RAB12	1.5 kW (2.0 hp)	1.1 kW (1.5 hp)

Model	Free speed r/min	Capacity				Morse taper No.	Length feed mm	Height		Weight		Hose dimension		Air consumption max output		Distance centre to side mm	Air inlet thread BSP	Ordering No.
		Drill- ing mm	Ream- ing mm	Tapp- ing mm	mm			in	kg	lb	mm	in	l/s	cfm				
RAB9 VR003	300	23	23	16	2	75	265	10.4	9.5	20.9	13	1/2	22	47	40	1/2	8421 5109 37	
RAB9 VR006	600	23	23	12	2	75	265	10.4	9.5	20.9	13	1/2	23	49	40	1/2	8421 5109 45	
RAB12 L150	140	51	40	32	4	90	385	15.2	14.9	32.8	16	5/8	30	64	50	1/2	8421 5112 08	
RAB12 L250	240	51	40	30	4	90	385	13.2	14.9	32.8	16	5/8	33	70	50	1/2	8421 5112 16	
RAB12 L450	475	32	32	24	3	90	340	13.4	12.9	28.4	16	5/8	32	68	50	1/2	8421 5112 24	

Accessories Included

Hose nipple

Optional Accessories

Square drive adapter

Morse taper No.	Square drive in	Ordering No.
3	1	4021 0394 00
4	1	4021 0395 00



Square drive adapter

Portable drilling precision for the aerospace industry

More automation in your drilling operations

In most traditional industries, close tolerance holes can be successfully drilled with a CNC machine. However, because a significant number of aircraft components are too large, too complex and too irregularly shaped to be taken to a machining center, portable drill motors must be taken to the plane itself. The wide range of hole sizes, the critically close tolerances required of those holes and the variety of materials used in the aerospace manufacturing industry demand that these portable precision drill motors be available with a broad range of cutter speeds and feed rate combinations.

As a rule of thumb Positive Feed Drills are used for holes larger than 4.8 mm / 3/16". These drills are significantly more versatile than CNC machinery but still more precise and productive than manual drills. Due to the torques generated when drilling large holes, it is not ergonomic, productive or safe to drill holes of this size manually.

PFD1500 – a useful, versatile drill

PFD1500 is a Positive Feed Drill in Right Angle execution, which is suitable for drilling critical and close tolerance holes with medium to large diameters. This drill is used all around the aircraft but is particularly useful in stacked materials and in assembly of structural parts, such as

fuselage, wing box, wing box assembly, pylon, landing gear and rudder. It is approved for use in all materials typically found in aerospace manufacturing, such as titanium, CFRP, aluminum and inco-nel.



- Governed air motor for consistent power under load, which significantly reduces cycle time.
- Double needle bearings for both feed- and drive gears ensures outstanding service life.
- The modular concept allows quick set-up, configuration and maintenance.
- The overload clutch ensures safe operation.
- The small angle head radius allows the tool to be used also in the most cramped locations around the air-plane.
- The integrated air logic controls the tool from one easily accessible button set.
- Low air consumption reduces cost for energy.
- The rapid advance option reduces cycle time.



Designation	Ordering No.
Base tool without rapid advance	
PFD1500RA-100	8440 1500 00
PFD1500RA-140	8440 1500 01
PFD1500RA-180	8440 1500 02
PFD1500RA-200	8440 1500 03
PFD1500RA-270	8440 1500 04
PFD1500RA-360	8440 1500 05
PFD1500RA-400	8440 1500 06
PFD1500RA-530	8440 1500 07
PFD1500RA-670	8440 1500 08
PFD1500RA-700	8440 1500 09
PFD1500RA-900	8440 1500 10
PFD1500RA-1200	8440 1500 11
PFD1500RA-1330	8440 1500 12
PFD1500RA-1770	8440 1500 13
PFD1500RA-2360	8440 1500 14
Base tool with rapid advance	
PFD1500RA-38-R	8440 1500 33
PFD1500RA-50-R	8440 1500 34
PFD1500RA-67-R	8440 1500 35
PFD1500RA-100-R	8440 1500 36
PFD1500RA-140-R	8440 1500 37
PFD1500RA-180-R	8440 1500 38
PFD1500RA-200-R	8440 1500 39
PFD1500RA-270-R	8440 1500 40
PFD1500RA-360-R	8440 1500 41
PFD1500RA-400-R	8440 1500 42
PFD1500RA-530-R	8440 1500 43
PFD1500RA-670-R	8440 1500 44
PFD1500RA-700-R	8440 1500 45
PFD1500RA-900-R	8440 1500 46

NOTE: Base tool needs to be combined with accessories shown on separate page.

Complete system

- Base tool Item 1-6
- Feed cassette Item 7
- Spindle Item 8
- Spindle guard Item 9
- Tool nose Item 11

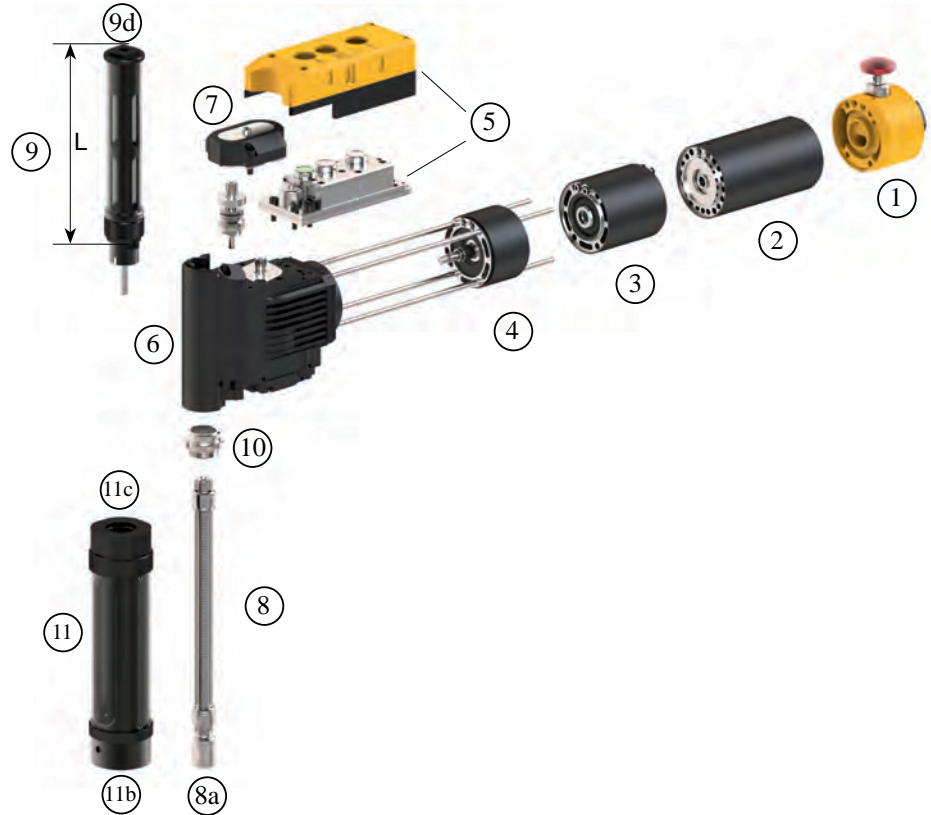

Tool noses (Item 11, b, c)

Length in	For bushing	Thread to tool (c)	Thread to bushing (b)	Ordering No.
For cutter up to 3/4"				
5	22000	Internal 1"-14	Internal 1"-14	4141 0261 90
8	22000	Internal 1"-14	Internal 1"-14	4141 0261 91
12	22000	Internal 1"-14	Internal 1"-14	4141 0261 92
3.25	23000	Internal 1"-14	Internal 1 1/4"-12	4141 0251 93
5	23000	Internal 1"-14	Internal 1 1/4"-12	4141 0251 90
8	23000	Internal 1"-14	Internal 1 1/4"-12	4141 0251 91
12	23000	Internal 1"-14	Internal 1 1/4"-12	4141 0251 92
3.75	24000	Internal 1"-14	Internal 1 1/2"-12	4141 0245 93
5	24000	Internal 1"-14	Internal 1 1/2"-12	4141 0245 92
8	24000	Internal 1"-14	Internal 1 1/2"-12	4141 0245 90
12	24000	Internal 1"-14	Internal 1 1/2"-12	4141 0245 91
8	25000	Internal 1"-14	Internal 2"-16	4141 0257 90
12	25000	Internal 1"-14	Internal 2"-16	4141 0257 91
For cutter up to 1 1/4"				
5IN-1-1-2-E	24000	External 1 9/16"-20 thread	Internal 1 1/2"-12	4141 0312 90
5IN-1-1-2-E	24000	External 1 9/16"-20 thread	Internal 1 1/2"-12	4141 0312 91
5IN-1-1-2-E	24000	External 1 9/16"-20 thread	Internal 1 1/2"-12	4141 0312 92
8IN-2-E	25000	External 1 9/16"-20 thread	Internal 2"-16	4141 0313 90
12IN-2-E	25000	External 1 9/16"-20 thread	Internal 2"-16	4141 0313 91

Spindles (Item 8, a)

	Length		Stroke		Thread (a)	Ordering No.
	in		in	mm		
7.5IN-3-8	7.5		2.7	69	3/8"-24	4141 0256 94
10IN-3-8	9.8		5.2	132	3/8"-24	4141 0256 90
12IN-3-8	11.8		7.2	183	3/8"-24	4141 0256 91
14IN-3-8	13.8		9.2	234	3/8"-24	4141 0256 92
16IN-3-8	15.7		11.2	284	3/8"-24	4141 0256 93
7.5IN-9-16	7.5		2.7	69	9/16"-18	4141 0004 94
9IN-9-16	8.8		4.2	107	9/16"-18	4141 0004 95
10IN-9-16	9.8		5.2	132	9/16"-18	4141 0004 90
12IN-9-16	11.8		7.2	183	9/16"-18	4141 0004 91
14IN-9-16	13.8		9.2	234	9/16"-18	4141 0004 92
16IN-9-16	15.7		11.2	284	9/16"-18	4141 0004 93
7.5IN-5-8	7.5		2.7	69	5/8"-18	4141 0224 94
9IN-5-8	8.8		4.2	107	5/8"-18	4141 0224 95
10IN-5-8	9.8		5.2	132	5/8"-18	4141 0224 90
12IN-5-8	11.8		7.2	183	5/8"-18	4141 0224 91
14IN-5-8	13.8		9.2	234	5/8"-18	4141 0224 92
16IN-5-8	15.7		11.2	284	5/8"-18	4141 0224 93

Spindle guard (Item 9, d)

For spindle	Length (L1)		Ordering No.
	in	mm	
7.5IN	3.9	99	4141 0068 94
9.0IN	5.4	137	4141 0068 95
10IN	6.4	163	4141 0068 90
12IN	8.3	211	4141 0068 91
14IN	10.3	262	4141 0068 92
16IN	12.3	313	4141 0068 93

Thread to coolant coupling 1/8" NPT (See illustration 9d)

Feed cassettes (Item 7)

Primary feed IPR	Secondary feed IPR	Ordering No.
0.001	0.016	4141 0034 91
0.002	0.015	4141 0034 92
0.003	0.014	4141 0034 93
0.004	0.013	4141 0034 94
0.006	0.010	4141 0034 95
0.008	0.008	4141 0034 96
0.010	0.006	4141 0034 97
0.013	0.004	4141 0034 98

Product accessories

Designation	Description	Ordering No
Indexer 1", adds 1.6 in of length to the tool	Indexer interface to tool nose: External 1"-20 thread	4141 0150 93
Indexer 1 9/16", adds 1.6 in of length to the tool	Indexer interface to tool nose: Internal 1 9/16"-20 thread	4141 0306 90
PFD1500 handle		4141 0302 90
Rapid advance retrofit kit		4141 0309 90
Motor valve with port	Port for connecting an external onboard dispenser or other device	4141 0098 92
Nose adapter		
for internal nose thread 2 1/4"	For nose with internal thread 2 1/4"	4141 0032 03
for internal nose thread 1.825"	For nose with internal thread 1.825"	4141 0032 07
for external nose thread 1 9/16"	For nose with external thread 1 9/16"	4141 0032 04
for 1 9/16" external to 2 1/4" external	To be used with 2 1/4" internal thread tool noses with indexer 1 9/16"	4141 0307 00
Tool nose extension 1"	Thread 1"-20	4141 0274 90
Range gear, rpm		
38/50/67		4141 0043 95
100/140/180		4141 0043 92
200/270/360		4141 0043 90
400/530/700		4141 0043 94
670/900/1200		4141 0043 93
1330/1770/2360		4141 0043 91
Chuck system		
Collet chuck for DA100 collets	External 9/16"-18 thread	4141 0282 90
Adapter 9/16" to 3/8"	For 3/8" jaw chuck mount	4141 0254 00
DA100 collet		
3/16"		4141 0300 10
15/64"		4141 0300 13
1/4"		4141 0300 14
5/16"		4141 0300 18
11/32"		4141 0300 20
3/8"		4141 0300 22
7/16"		4141 0300 26
15/32"		4141 0300 28
1/2"		4141 0300 30
9/16"		4141 0300 34
4.5 mm		4141 0305 05
5.5 mm		4141 0305 07
6.5 mm		4141 0305 09
7.0 mm		4141 0305 10
8.0 mm		4141 0305 12
9.5 mm		4141 0305 15

Vacuum device

For nose	Bushing series	Ordering No.
5	22000	4141 0250 91
8	22000	4141 0250 92
12	22000	4141 0250 94
5	23000	4141 0250 93
8	23000	4141 0250 95
12	23000	4141 0250 96
5	24000	4141 0330 90
8	24000	4141 0250 90
12	24000	4141 0250 97
8	25000	4141 0250 98
12	25000	4141 0250 99



Vacuum device



Range gear

Service Kits

Service kit for	Ordering No.
Feed cassette	4082 0037 90
Spindle guard	4081 0460 90
Head part 1	4081 0452 90
Head part 2	4081 0453 90
Head part 3	4081 0455 90
Range gear	4081 0458 90
Motor	4081 0457 90
Motor valve	4081 0456 90



Vacuum device with tool nose



Handle

NOTE: Please see the product information sheet (PI) available at <http://servaidweb.atlascopco.com> for a complete list of spare parts.



Automatic Drilling and Tapping Units

Contents	Page
Automatic drilling and tapping units	265
Dimension sketches	268

More mechanization in your drilling operations

Simple and cost effective, Atlas Copco automatic drilling and tapping units cut costs by reducing machining time in ancillary equipment, or in highly automated special machines. Modular designs allow the units to be easily replaced, transferred to other machines, or combined to form new special-purpose machines.



Selection Guide

Dimensions in mm



Steel



Aluminum

LBL45

025	015	010	007	003
—	7.0	10.0	14.0 (M8)	20.0 (M12)
10.0	14.0	16.0	22.0 (M12)	32.0 (M16)

LBL35

054	030	014	007
3.0	5.0	8.0 (M4)	11.0 (M8)
5.0	7.0	10.0 (M5)	13.0 (M10)

LBL25

220	049	022	011
1.2	3.2	5.0	8.0
2.0	5.0	6.5	10.0

These units are available in three sizes, LBL25, LBL35 and LBL45, each size covering a specific diameter range, totally up to 32 mm in aluminium.

The basic units can be fitted with different chucks, twin heads for simultaneous drilling of two holes and attachments for chip removal and tapping.

- **Highly dependable** – LBL drilling and tapping units feature quick and precise clamping, making them highly dependable.
- **Easy to build together** – Several holes can be drilled in a single operation since several of these compact units can easily be built together.
- **Low noise level** – The units have a low noise level as the exhaust air is discharged through silencers inside the protective casing.



Model	Capacity		Feed force N	Max output		Feed stroke mm	Free speed r/min	Weight		Air consumption				Ordering No.
	Steel mm	Alumi- num mm		kW	hp			kg	lb	Max output		Free speed		
LBL25E 220	1.2	2.0	350	0.22	0.3	80	21000	3	6.6	5.2	11	5.8	12	8421 9208 47
LBL25E 049	3.2	5.0	350	0.22	0.3	80	4600	3	6.6	5.2	11	5.8	12	8421 9208 55
LBL25E 022	5.0	6.5	350	0.22	0.3	80	2100	3	6.6	5.2	11	5.8	12	8421 9208 63
LBL25E 011	8.0	10.0	350	0.22	0.3	80	1100	3	6.6	5.2	11	5.8	12	8421 9208 71
LBL35E 007	11.0 ^c	13.0 ^d	1050	0.33	0.5	80	700	7	15.0	9.5	21	10.6	22	8421 9308 04
LBL35E 014	8.0 ^a	10.0 ^b	1050	0.33	0.5	80	1400	7	15.0	9.5	21	10.6	22	8421 9308 12
LBL35E 030	5.0	7.0	1050	0.33	0.5	80	3000	7	15.0	9.5	21	10.6	22	8421 9308 38
LBL35E 054	3.0	5.0	1050	0.33	0.5	80	5400	7	15.0	9.5	21	10.6	22	8421 9308 46
LBL45E 003	20.0 ^e	32.0 ^f	2500	0.80	1.1	120	320	16	35.0	20.0	44	9.0	19	8421 9408 03
LBL45E 007	14.0 ^c	22.0 ^d	2500	0.80	1.1	120	700	16	35.0	20.0	44	9.0	19	8421 9408 29
LBL45E 010	10.0	16.0	2500	0.80	1.1	120	1000	16	35.0	20.0	44	9.0	19	8421 9408 37
LBL45E 015	7.0	14.0	2500	0.80	1.1	120	1500	16	35.0	20.0	44	9.0	19	8421 9408 45
LBL45E 025	-	10.0	2500	0.80	1.1	120	2500	16	35.0	20.0	44	9.0	19	8421 9408 52

Recommended max tapping size: ^aM4 ^bM5 ^cM8 ^dM10 ^eM12 ^fM16

Optional Accessories

LBL25

Designation	Ordering No.
Hydraulic damper (feed stroke 65 mm)	4130 1844 80
Key chuck (0-6.5 mm)	4021 0283 00
Key chuck (2-10 mm)	4021 0416 00



Hydraulic damper

LBL35

Designation	Ordering No.
Hydraulic damper (feed stroke 65 mm)	4130 1844 80
Key chuck (2.0-13.0 mm)	4021 0452 00
Sleeve chuck (2.0-9.5 mm)	4021 0459 00
Twin spindle head, speed ratio 1:1, center to center adjustment range 12.7-63.5 mm	4130 1363 84
Other multiple heads on request	
Tapping unit, M2-M7 SPD3, Taper socket J33	4130 1938 00
Holder for tapping unit SPD3	4130 1787 00
Collet 2.5-5 mm	4021 0412 00
Collet 5-6.3 mm	4021 0413 00
Tapping unit, M3-M12 SPD5, Tapping Socket J33	4130 1939 00
Holder for tapping unit SPD5	4130 1860 00
Collet 3.3-6.8 mm	4021 0337 00
Collet 4.5-8.7 mm	4021 0336 00
Collet 6-10 mm	4021 0456 00



Key chuck



Sleeve chuck

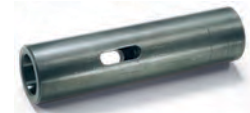

Morse taper socket

LBL45

Designation	Ordering No.
Hydraulic damper (feed stroke 110 mm)	4130 1895 80
Key chuck (3.2-16.0 mm)	4021 0423 00
Sleeve chuck (2.0-9.5 mm)	4021 0458 00
No. 2 Morse taper socket	4130 1080 00
No. 3 Morse taper socket	4130 1079 00
Twin spindle head, speed ratio 1:1, center to center adjustment range 19-95 mm	4130 1364 82
Other multiple heads on request	
Tapping unit, M15-M18 SPD7, Taper socket, J3	4130 1940 00
Holder for tapping unit SPD7	4130 1773 00
Collet 6-10 mm	4023 1059 00



Tapping unit



Twin spindle head

Optional Accessories

Programmed damping device

Model	Ordering No.
LBL35, -45	4130 1961 80

To be used together with the hydraulic damper.

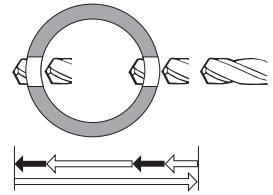

Programmed damping device

Collets for Sleeve chuck LBL35/45 Twin head LBL45

Size mm	Ordering No.
3.5	4130 1561 15
3.6	16
3.7	17
4.0	4130 1561 20
4.6	26
5.0	4130 1561 30
5.5	35
6.0	4130 1561 40
6.4	44
6.5	45
6.7	47
6.9	49
7.0	4130 1561 50
8.0	4130 1561 60
8.5	65
9.0	4130 1561 70
9.5	75

Collets for Twin head LBL35

Size mm	Ordering No.
2.1	4130 1367 11
3.2	4130 1367 22
4.0	4130 1367 30
5.0	4130 1367 40
5.1	4130 1367 41
6.2	4130 1367 52
6.5	4130 1367 55

Mountings

Ref. No.	Designation	Ordering No.	
		LBL25, LBL35	LBL45
1	Base plate	4140 0077 80	4140 0081 80
2	Base plate	4140 0080 80	4140 0084 80
8	Locking bar	4140 0078 00 ^a	4140 0082 00 ^a
9	Locking bar	4140 0079 00 ^a	4140 0083 00 ^a

^a Two per unit.

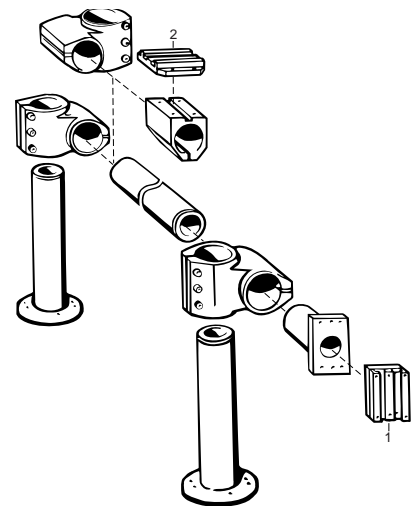

Optional Accessories

Tip mount

Model	Max stroke	Dimensions, mm			Ordering No.
		L	D	M	
LBL35	73	159	60	M56x1.5L	4140 0090 80
LBL45	110	215	80	M56x1.5L	4140 0092 80

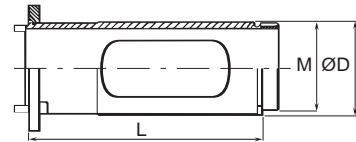

Drill guide (Screw mount)

A ^a	B	C	D	Dimensions, mm					Ordering No.
				E	F	G	H	I	
8	M56x1.5L	60	39	25	6.2	-	-	-	4140 0044 08
10	M56x1.5L	60	39	25	6.2	-	-	-	4140 0044 10
12	M56x1.5L	60	39	25	6.2	-	-	-	4140 0044 12

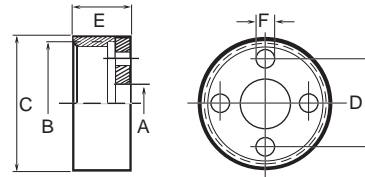

^a Dimensions mentioned under A refer to the outside diameter for drill guide bushings.

Drill guide (Bayonet mount)

A ^a	B	C	D	Dimensions, mm					Ordering No.
				E	F	G	H	I	
4	M56x 1.5L	60	30	37	-	-	40h8	6.2	4140 0058 04
18	M56x 1.5L	60	30	37	-	-	40h8	6.2	4140 0058 18

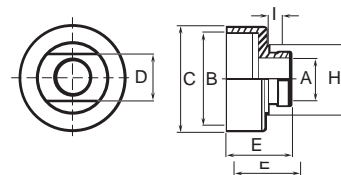

^a Dimensions mentioned under A refer to the outside diameter for drill guide bushings.

Drill guide (Bayonet mount)

A ^a	B	C	D	Dimensions, mm					Ordering No.
				E	F	G	H	I	
-	-	56	36	15	6.5	67	40F8	-	4140 0059 80

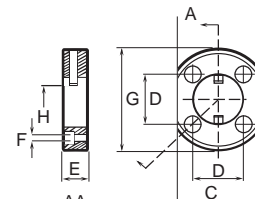

^a Dimensions mentioned under A refer to the outside diameter for drill guide bushings.

Dimensions

Dimension sketch – LBL25

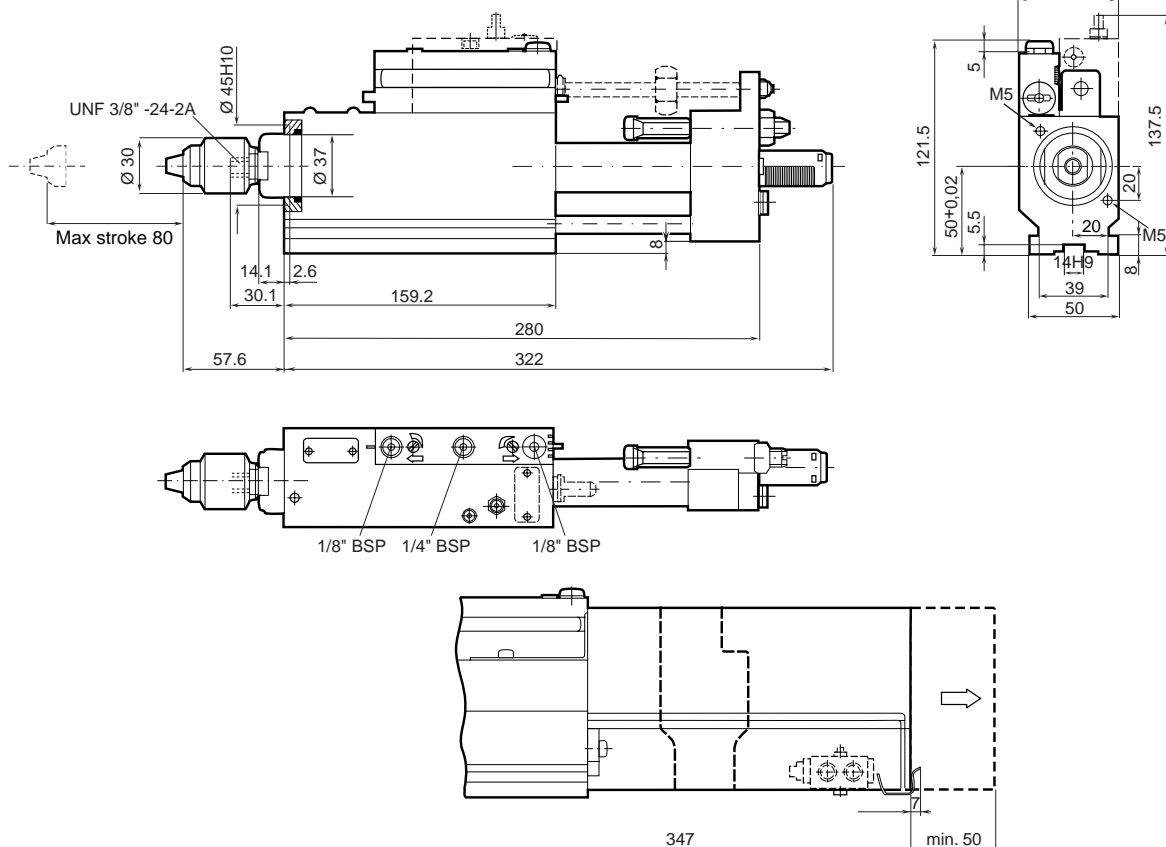

Dimension sketch – LBL35

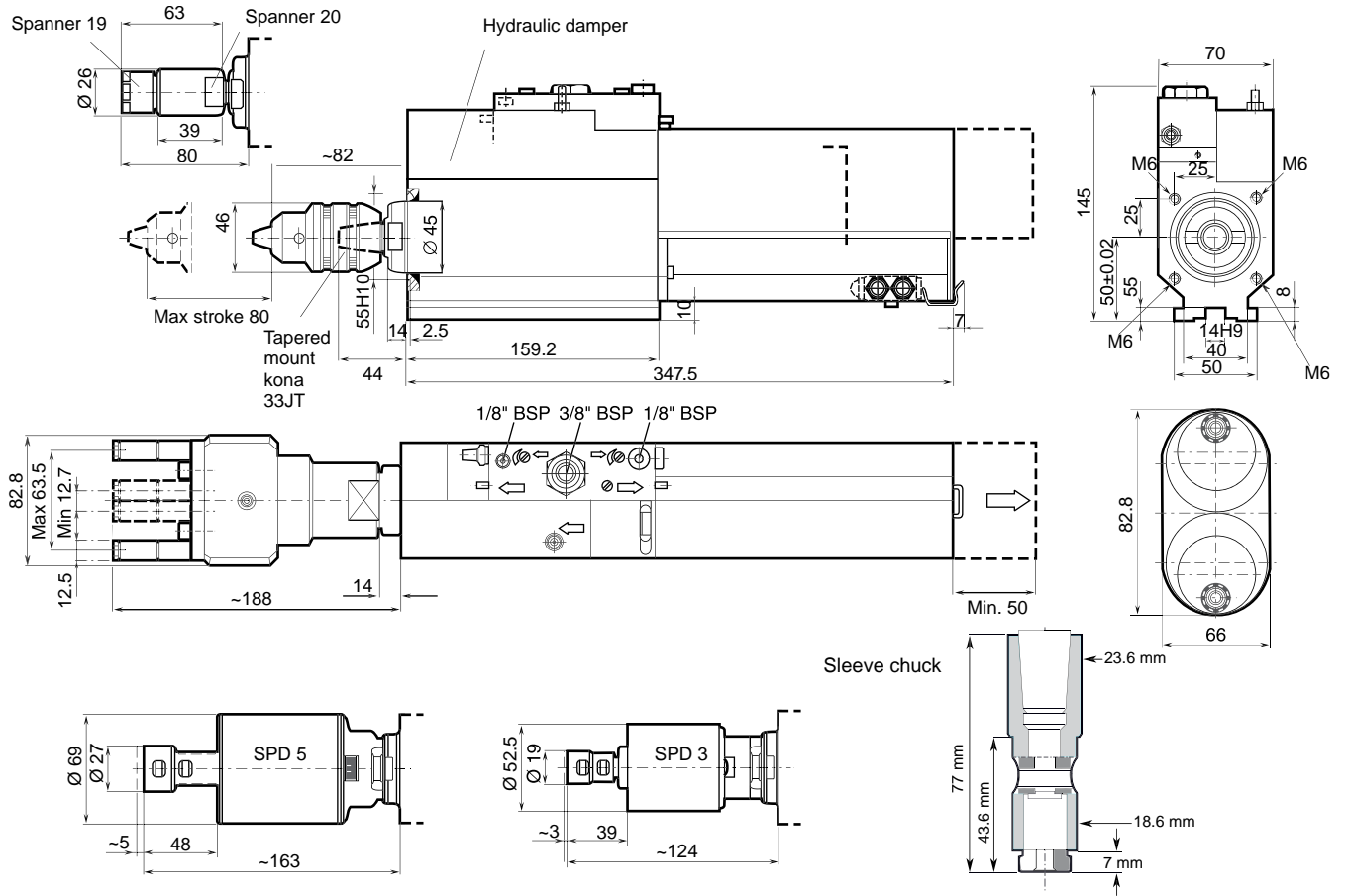

Dimension sketch – LBL45

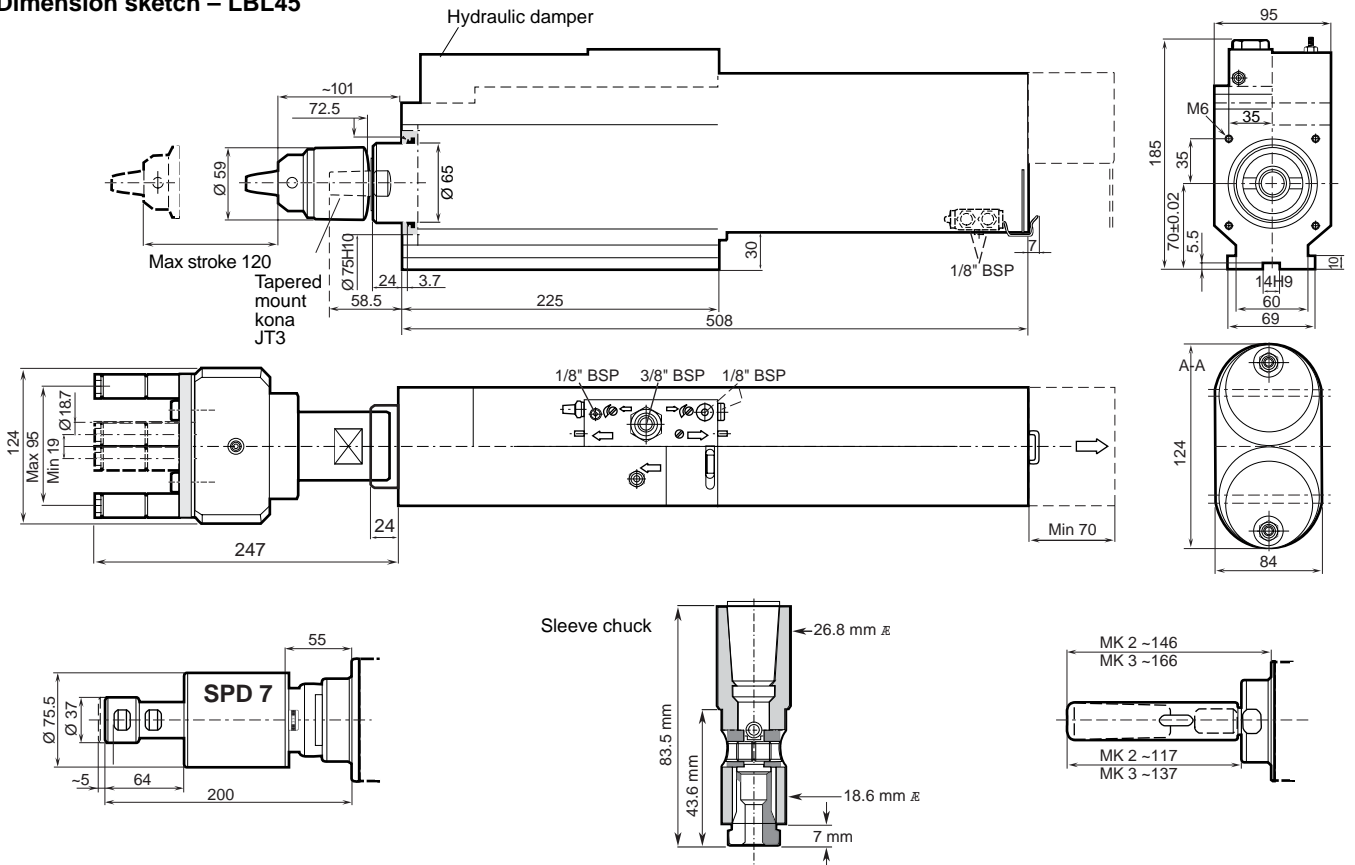

Dimension sketch – Mountings for LBL25E and -35E

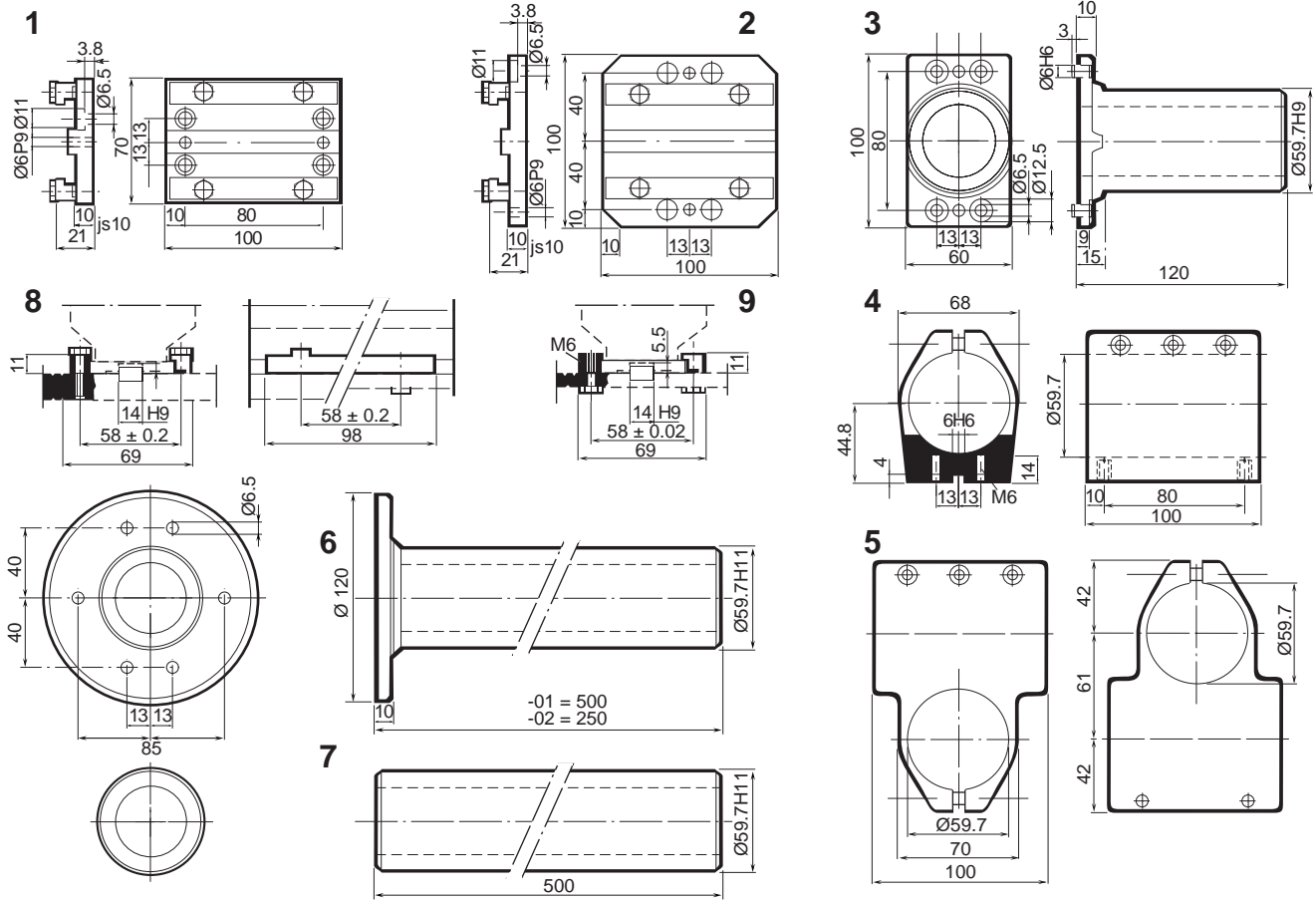

Dimension sketch – Mountings for LBL45E

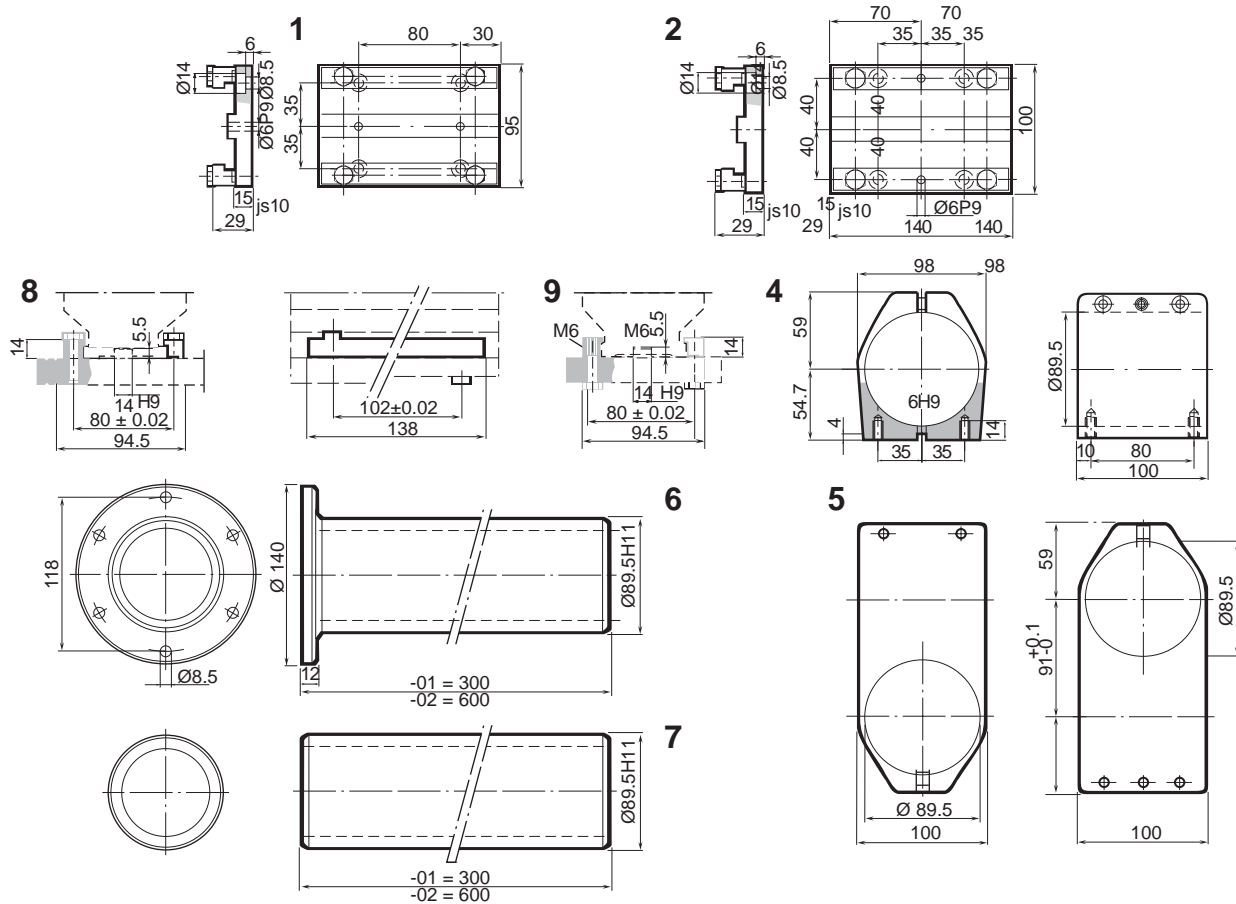

Air Line Accessories



Contents

Page

Introduction.....	272
Product safety.....	273
Air preparation units	274
Optimizer air tool oil.....	281
Direct lubrication units	282
Quick couplings	284
Claw couplings	308
Ball valves	309
Swivel connectors.....	310
Fittings	311
Blow protector.....	314
Hoses	315
Spiral hoses.....	320
Productivity kits.....	321
Pre-mounted hose kits.....	322
Hose reels	323
Balancers.....	327
Blow guns.....	330
Test equipment	331
AIRnet.....	332

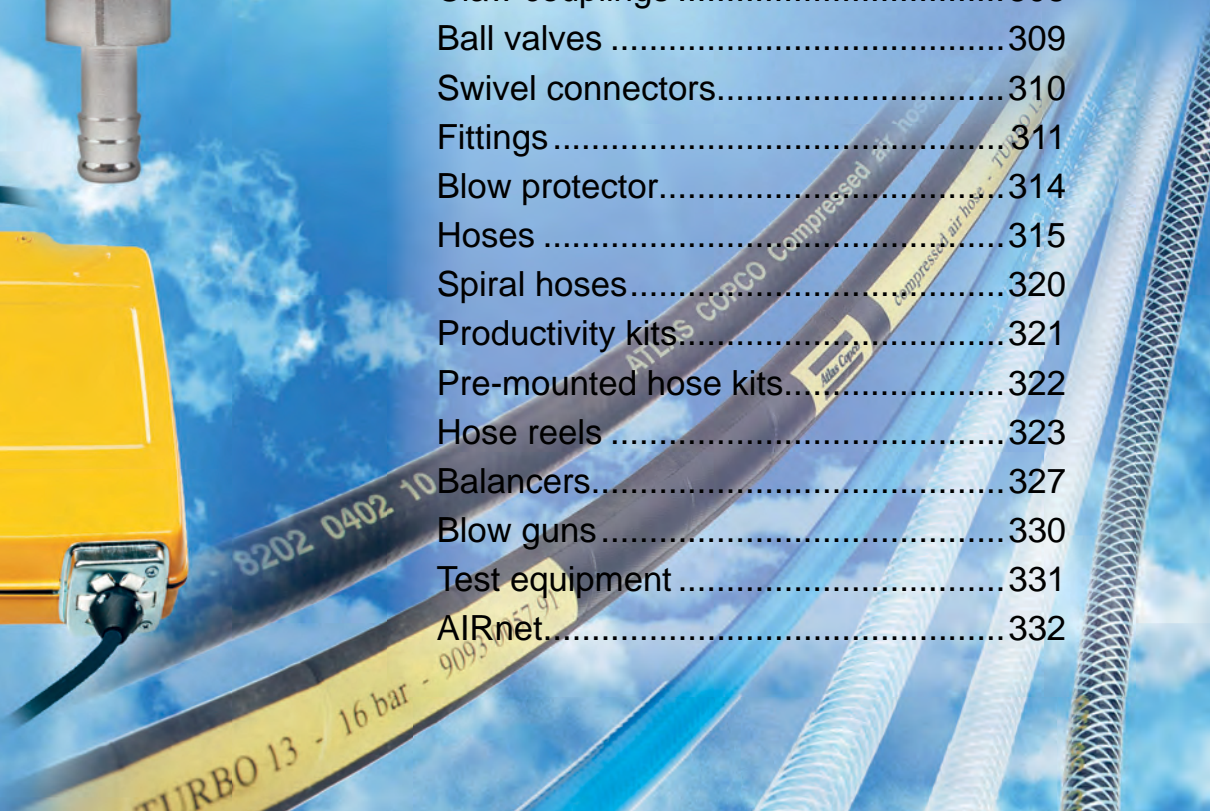

Ensure that your tools achieve their full potential

To ensure that you benefit from the full potential power of your tools, Atlas Copco has developed a full range of air line accessories for use with Atlas Copco tools and air motors. All accessories can be used for other applications and pneumatic equipment.

Productivity

By using Atlas Copco's air line accessories you ensure that you have a correct air line installation for your tool. This will provide the correct air flow to the tool, ensuring that you benefit from its full potential power, and that you reach the correct torque in torque-controlled tools. By using the recommended accessories you will also minimize the service requirements of the tool.

Energy efficiency

With a correct installation you will not only achieve the tool's full potential power, you will also reduce energy costs. All Atlas Copco accessories are designed for minimum pressure drop, which ensures that the compressor is not "working overtime".

Safety

All accessories are designed to meet the highest demands for a safe working environment. Atlas Copco has developed a wide range of safety couplings, balancers, blow protectors and hose reels to meet today's high standards in terms of workplace safety.

Ergonomics

Operator health and well-being are important factors. Atlas Copco accessories, such as torque arms, balancers, screw presenters and reaction bars, enable you to configure ergonomically correct workstations for your operators.

Quality

All Atlas Copco accessories are made of the highest quality materials for long production cycles and to withstand rough treatment. Choose Atlas Copco accessories and you will be sure of high quality products.

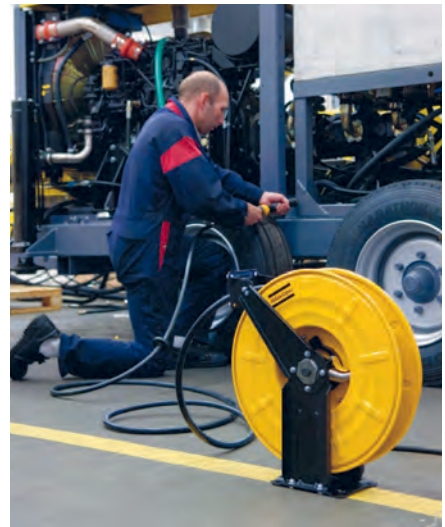

All local safety regulations with respect to installation, operation and overhaul must always be followed. Please read the separate instructions regarding safety which are supplied with all products in order to improve your own safety!

Ball valve

- Switch off the compressed air with the ball valve when you are not working (see fig. 1).
- Open all ball valves gently in order to discover improperly tightened devices (see fig. 5).

Air preparation units

- Please check for solvents which change the structure of polycarbonate^a bowls.

These solvents make the polycarbonate brittle so it can break. Normally polycarbonate is not easy to break. If you need to use aggressive solvents, please contact us and we will help you choose the right equipment.

- Use bowl guard.

An easy way to eliminate this type of accident is to use a bowl guard on MINI and MIDI units. The MAXI unit has an aluminum bowl with a new, more chemical resistant plastic on the inside as standard.

Check that the bowls are properly tightened and that all units are fitted together before switching on the compressed air with the ball valve.

Quick safety couplings

To increase the safety and reduce the risk of operator injuries we recommend you to always buy couplings with a safety function. Couplings with a safety function are disconnected in two stages in order to vent the coupling and minimize the risk of sudden component separation, which has the potential to cause operator injury.

Follow this order when working with claw couplings.

How to open a claw coupling:

- 1 Close the ball valve.



- 2 Run the tool so the air ventilates out.



- 3 Release the claw coupling.



How to close a claw coupling:

- 4 Make sure that the two claw couplings are mounted together. Use claw couplings with lock nut (LNH) or use a lock spring for safer locking.



Never open a quick coupling with a screwdriver in order to ventilate the air.

Claw couplings

- Be very careful (see fig. 1+2+3).

They are always open and must be used very carefully. To increase safety when using claw couplings, we recommend the claw LNH claw coupling with a lock nut.

Clamps and connections

- Avoid screwdrivers when tightening.

Check that they are properly tightened. Avoid screwdrivers when tightening, they can easily slip and damage your hand. Use a wrench. If you need to use a screwdriver, mount the clamp in a vice.

Hoses

When mounting hoses on hose connections, use water and soap in order to make the hose slip on to the connection. Do not use oil. Water and soap will dry up. Remove leaking hoses. A small leakage can quickly become a large hole.

Blow protector (see fig. 6+7).

A dangerous situation can arise with a hose that is accidentally blowing compressed air in an uncontrolled way, causing it to whip.

Blow guns

- Use the safety version. It eliminates the risk of air at high pressure coming into direct contact with skin.

^a Polycarbonate has good chemical resistance to all solvents except chemicals containing acetone, benzol, glycerine, some hydraulic and synthetic oils, chloroform, methyl alcohol, carbon tetrachloride (and similar solvents), carbon disulphide, perchloroethylene, toluene, trichloroethylene, xylene (nitrocellulose, thinner), acetic acid.

- 5 Open the ball valve gently.



Use of blow protector:

- 6 This dangerous situation can be avoided by using a blow protector.

A BLOCK blow protector shuts off the air flow so the risk of personal injuries is minimized.



- 7 We strongly recommend the use of blow protector BLOCK when using claw couplings.

When a broken hose has been replaced and the compressed air is switched on again, the BLOCK is automatically reset.

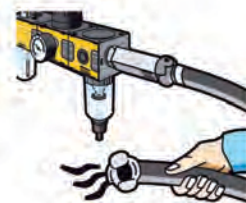

Get maximum productivity from your tools

Atlas Copco air preparation units are designed to help you get maximum productivity from your tools. They ensure minimal pressure drop and thus minimum energy losses in the air distribution system, benefiting the environment and cutting your operating costs. The lifetimes of your tools will be extended by using air preparation units and with that comes lower repair costs and less downtime. A correct air installation ensures productivity and good total economy.

Filter – FIL

Water and dirt in your compressed air system will cause extensive corrosion damage and wear.

Productivity

Atlas Copco filters are equipped with a cyclone system. Using centrifugal force, this separates out a high percentage of the heavier solid water particles, while the filter ensures that the amount of dirt entering your tool is kept to a minimum. This means longer working cycles for the tools and minimum service time.

Regulator – REG

Atlas Copco regulators ensure optimal flow at the specific flow rates required by Atlas Copco tools, or any other pneumatic tools.

Energy efficiency

By installing a regulator you will ensure that there will not be any unnecessary consumption of compressed air. The regulators reduce a variable primary pressure to a practically constant secondary pressure with a minimum of pressure drop.

Productivity

The regulator will optimize the performance of your tool, ensure torque accuracy and boost productivity.

Lubricator – DIM

Atlas Copco oil lubricators ensure a long, efficient and trouble-free life for your pneumatic tools and components.

Productivity

The use of a lubricator will increase the power in vane motors by about 10-15%.

Energy efficiency

With the use of a lubricator you will prolong the lifetime of a vane motor up to three times and the motor will work much more efficiently, and with less friction.



Filter – FIL



Regulator – REG



Lubricator – DIM

Air preparation unit MINI-K's main application is to prepare the air for pneumatic components. MINI-K units have a 1/4" BSP connection thread, a composite housing made of polyamide 66 and the bowls are made of polycarbonate.

Working temperature

0°C to +50°C at 10 bar

Operating pressure

Inlet pressure 0-10 bar

Outlet pressure 0.5-8 bar

Standard filter

30 µm

Pressure gauge

1/8" BSP



Model	Economical air flow l/s	Maximum air flow l/s	Bowl	Filter condensate drainage	Max condensate capacity cm ³	Max oil capacity cm ³	Weight kg	Ordering No.
Filters								
MINI FIL 08K-B	12	30	Polycarbonate	Manual	12	-	0.1	9092 0000 01
Regulators								
MINI REG 08K	10	20	-	-	-	-	0.11	9092 0000 61
Lubricators								
MINI DIM 08K	9	23	Polycarbonate	-	-	35	0.09	9092 0000 91
Filter/regulator								
MINI F/R 08K	12	17	Polycarbonate	Manual	12	-	0.12	9092 0001 21
Filter/regulator+lubricator								
MINI F/RD 08K	9	14	Polycarbonate	Manual	12	35	0.32	9092 0001 51

NOTE: **Economical air flow:** 8 bar inlet pressure, 6.3 bar outlet pressure, 0.2 bar pressure drop.

Maximum air flow: 10 bar inlet pressure, 6.3 bar outlet pressure, 1 bar pressure drop.

All separate units, mounting brackets, assembly kits and pressure gauges need to be ordered separately. MINI-K F/RD unit is delivered complete with mounting bracket, assembly kit and pressure gauge.

Air preparation unit MINI-B's main application is to prepare the air for pneumatic components and tools with low air consumption. MINI-B has a 1/4" BSP connection thread and the housing is made of diecast zinc. The bowls are made of polycarbonate or the unit has metal bowls in zinc.

Working temperature

0°C to +50°C at 10 bar

Operating pressure

Inlet pressure 0-16 bar

Outlet pressure 0.5-8 bar

Standard filter

30 µm

Pressure gauge

1/8" BSP



Model	Economical air flow l/s	Maximum air flow l/s	Bowl	Filter condensate drainage	Max condensate capacity cm ³	Max oil capacity cm ³	Weight kg	Ordering No.
Filters								
MINI FIL 08B-B	12	24	Polycarbonate	Semi/automatic	22	-	0.25	9093 0032 11
MINI FIL 08B-C	12	24	Polycarbonate	Manual	22	-	0.25	9093 0032 41
MINI FIL 08B-D	13	24	Metal	Manual	22	-	0.25	9093 0032 71
Regulators								
MINI REG 08B	9	47.5	-	-	-	-	0.30	9093 0033 01
MINI REG 08B-LP	9	47.5	-	-	-	-	0.30	9093 0073 21
MINI REG 08P	8	47.5	-	-	-	-	0.30	9093 0000 31
Lubricators								
MINI DIM 08B	12	23	Polycarbonate	-	-	45	0.25	9093 0033 31
MINI DIM 08B-D	12	23	Metal	-	-	45	0.25	9093 0033 61
Filter/regulator								
MINI F/R 08B-B	9	38	Polycarbonate	Semi/automatic	22	-	0.35	9093 0033 91
MINI F/R 08B-C	9	38	Polycarbonate	Manual	22	-	0.35	9093 0034 21
Filter/regulator+lubricator								
MINI F/RD 08B-B	9	14.8	Polycarbonate	Semi/automatic	22	45	0.75	9093 0034 51
MINI F/RD 08B-C	9	14.8	Polycarbonate	Manual	22	45	0.75	9093 0034 81
Filter+regulator+lubricator								
MINI FRD 08B-B	9	13.8	Polycarbonate	Semi/automatic	22	45	0.95	9093 0062 11
MINI FRD 08B-C	9	13.8	Polycarbonate	Manual	22	45	0.95	9093 0062 41

NOTE: Economical air flow: 8 bar inlet pressure, 6.3 bar outlet pressure, 0.2 bar pressure drop.

Maximum air flow: 10 bar inlet pressure, 6.3 bar outlet pressure, 1 bar pressure drop.

All separate units, mounting brackets, assembly kits and pressure gauges need to be ordered separately. The MINI F/RD and FRD units are delivered complete with mounting bracket, assembly kit and pressure gauge.

The MIDI Optimizer is suitable for more than 90% of the Atlas Copco tool range and is the best choice for assembly tools, percussive tools, drills, nibblers and grinders up to Turbo. The MIDI Optimizer has a 1/2" BSP connection thread and a housing and bowl of high-tech polymer. The bowl has a highly chemical resistant polypropylene insert and the bowl is directly screwed to the housing for easy handling.

MIDI Optimizer self-regulating nano-lubricator

Adjusts automatically to the flow demand and ensures that the right amount of oil is supplied to the motor at all flow rates. This minimizes the lubrication needed. The nano oil mist, with a particle size of 200 nm, can be transported by the air stream up to 40 m. This means there is no oil in the hose and direct lubrication is not necessary. The lubricator can be refilled during operation. EP-versions are adjusted for use with impulse tools.



Working temperature

-40°C to +60°C at 10 bar
+2°C to +60°C at 10 bar for filters

NOTE: For dry compressed air, ice formation must be avoided.

Operating pressure

Inlet pressure 0-16 bar
Outlet pressure 0.5-8 bar
Outlet pressure, HP versions 0.5-16 bar

Standard filter

30 µm

Pressure gauge

1/4" BSP
Included in F/RD and FRD units

Model	Economical air flow l/s	Maximum air flow l/s	Bowl	Filter condensate drainage	Max condensate capacity cm ³	Max oil capacity cm ³	Weight kg	Ordering No.
Filters								
MIDI Optimizer FIL A	-	117	Polymer, plastic insert	Automatic	60	-	0.3	9093 0021 01
MIDI Optimizer FIL M/S	-	117	Polymer, plastic insert	Manual/semi auto	60	-	0.3	9093 0021 02
Regulators								
MIDI Optimizer REG	-	97	-	-	-	-	0.35	9093 0021 05
MIDI Optimizer REG LP	-	97	-	-	-	-	0.35	9093 0021 06
MIDI Optimizer REG HP	-	97	-	-	-	-	0.35	9093 0021 30
Lubricators								
MIDI Optimizer DIM	31	120	Polymer, plastic insert	-	-	90	0.3	9093 0021 10
MIDI Optimizer DIM EP	31	120	Polymer, plastic insert	-	-	90	0.3	9093 0021 33
Filter/regulator								
MIDI Optimizer F/R A	-	90	Polymer, plastic insert	Automatic	60	-	0.5	9093 0021 12
MIDI Optimizer F/R M/S	-	90	Polymer, plastic insert	Manual/semi auto	60	-	0.5	9093 0021 13
MIDI Optimizer F/R M/S HP	-	90	Polymer, plastic insert	Manual/semi auto	60	-	0.5	9093 0021 31
MIDI Optimizer F/R HP A	-	90	Polymer, plastic insert	Automatic	60	-	0.5	9093 0021 32
Filter/regulator+lubricator								
MIDI Optimizer F/RD A	31	55	Polymer, plastic insert	Automatic	60	90	1.0	9093 0021 16
MIDI Optimizer F/RD M/S	31	55	Polymer, plastic insert	Manual/semi auto	60	90	1.0	9093 0021 17
MIDI Optimizer F/RD A EP	31	55	Polymer, plastic insert	Automatic	60	90	1.0	9093 0021 35
MIDI Optimizer F/RD M/S EP	31	55	Polymer, plastic insert	Manual/semi auto	60	90	1.0	9093 0021 36
Filter+regulator+lubricator								
MIDI Optimizer FRD A	31	55	Polymer, plastic insert	Automatic	60	90	1.1	9093 0021 24
MIDI Optimizer FRD M/S	31	55	Polymer, plastic insert	Manual/semi auto	60	90	1.1	9093 0021 25

NOTE: **Economical air flow:** 8 bar inlet pressure, 6.3 bar outlet pressure, 0.2 bar pressure drop.

Maximum air flow: 10 bar inlet pressure, 6.3 bar outlet pressure, 1 bar pressure drop.

All separate units, mounting brackets, assembly kits and pressure gauges need to be ordered separately. The MIDI Optimizer F/RD and FRD units are delivered complete with mounting bracket, assembly kit and pressure gauge.

EP For pulse tools, lubricator adjusted for impulsing tools
A Automatic
M/S Manual/semi automatic
HP High pressure regulator
LP Lockable regulator

The MIDI Optimizer is suitable for more than 90% of the Atlas Copco tool range and is the best choice for assembly tools, percussive tools, drills, nibblers and grinders up to Turbo. The MIDI Optimizer has a 3/4" BSP connection thread and a housing and bowl of high-tech polymer. The bowl has a highly chemical resistant polypropylene insert and the bowl is directly screwed to the housing for easy handling.

MIDI Optimizer self-regulating nano-lubricator

Adjusts automatically to the flow demand and ensures that the right amount of oil is supplied to the motor at all flow rates. This minimizes the lubrication needed. The nano oil mist, with a particle size of 200 nm, can be transported by the air stream up to 40 m. This means there is no oil in the hose and direct lubrication is not necessary. The lubricator can be refilled during operation. EP-versions are adjusted for use with impulse tools.



Working temperature

-40°C to +60°C at 10 bar
+2°C to +60°C at 10 bar for filters

NOTE: For dry compressed air, ice formation must be avoided.

Operating pressure

Inlet pressure 0-16 bar
Outlet pressure 0.5-8 bar
Outlet pressure, HP versions 0.5-16 bar

Standard filter

30 µm

Pressure gauge

1/4" BSP
Included in F/RD and FRD units

Model	Economical air flow l/s	Maximum air flow l/s	Bowl	Filter condensate drainage	Max condensate capacity cm ³	Max oil capacity cm ³	Weight kg	Ordering No.
Filters								
MIDI Optimizer 3/4" FIL A	-	117	Polymer, plastic insert	Automatic	60	-	0.3	9093 0021 40
MIDI Optimizer 3/4" FIL M/S	-	117	Polymer, plastic insert	Manual/semi auto	60	-	0.3	9093 0021 41
Regulators								
MIDI Optimizer 3/4" REG	-	97	-	-	-	-	0.35	9093 0021 42
MIDI Optimizer 3/4" REG LP	-	97	-	-	-	-	0.35	9093 0021 43
MIDI Optimizer 3/4" REG HP	-	97	-	-	-	-	0.35	9093 0021 44
Lubricators								
MIDI Optimizer 3/4" DIM	31	120	Polymer, plastic insert	-	-	90	0.3	9093 0021 45
MIDI Optimizer 3/4" DIM EP	31	120	Polymer, plastic insert	-	-	90	0.3	9093 0021 54
Filter/regulator								
MIDI Optimizer 3/4" F/R A	-	90	Polymer, plastic insert	Automatic	60	-	0.5	9093 0021 46
MIDI Optimizer 3/4" F/R M/S	-	90	Polymer, plastic insert	Manual/semi auto	60	-	0.5	9093 0021 47
MIDI Optimizer 3/4" F/R M/S HP	-	90	Polymer, plastic insert	Manual/semi auto	60	-	0.5	9093 0021 48
MIDI Optimizer F/R 3/4" HP A	-	90	Polymer, plastic insert	Automatic	60	-	0.5	9093 0021 49
Filter/regulator+lubricator								
MIDI Optimizer 3/4" F/RD A	31	55	Polymer, plastic insert	Automatic	60	90	1.0	9093 0021 50
MIDI Optimizer 3/4" F/RD A EP	31	55	Polymer, plastic insert	Automatic	60	90	1.0	9093 0021 55
MIDI Optimizer 3/4" F/RD M/S	31	55	Polymer, plastic insert	Manual/semi auto	60	90	1.0	9093 0021 56
MIDI Optimizer 3/4" F/RD M/S EP	31	55	Polymer, plastic insert	Manual/semi auto	60	90	1.0	9093 0021 51
Filter+regulator+lubricator								
MIDI Optimizer 3/4" FRD A	31	55	Polymer, plastic insert	Automatic	60	90	1.1	9093 0021 52
MIDI Optimizer 3/4" FRD M/S	31	55	Polymer, plastic insert	Manual/semi auto	60	90	1.1	9093 0021 53

NOTE: **Economical air flow:** 8 bar inlet pressure, 6.3 bar outlet pressure, 0.2 bar pressure drop.

Maximum air flow: 10 bar inlet pressure, 6.3 bar outlet pressure, 1 bar pressure drop.

All separate units, mounting brackets, assembly kits and pressure gauges need to be ordered separately. The MIDI Optimizer F/RD and FRD units are delivered complete with mounting bracket, assembly kit and pressure gauge.

EP For pulse tools, lubricator adjusted for impulsing tools
A Automatic
M/S Manual/semi automatic
HP High pressure regulator
LP Lockable regulator

The high flow MAXI-B air preparation unit's main application is to prepare the air for pneumatic tools which are large air consumers when long distribution hoses and multi connectors are used. A good example is Atlas Copco Turbo grinders. The MAXI-B has a diecast zinc housing and aluminum bowls with polypropylene inserts and the bowl is directly screwed to the housing for easy handling.

Working temperature

-10°C to +50°C at 10 bar

NOTE: For dry compressed air, ice formation must be avoided.

Operating pressure

Inlet pressure 0-17.5 bar

Outlet pressure 0.5-12 bar

Standard filter

30 µm

Pressure gauge

1/4" BSP



Model	Economical air flow l/s	Maximum air flow l/s	Bowl	Filter condensate drainage	Max condensate capacity cm ³	Max oil capacity cm ³	Weight kg	Ordering No.
Filters								
MAXI FIL 25B-B	106	190 ^a	Metal	Semi/automatic	130	-	0.9	9093 0074 21
Regulators								
MAXI REG 25B	85	333	-	-	-	-	1.2	9093 0074 61
MAXI REG 25B-LP	85	333	-	-	-	-	1.2	9093 0074 81
Lubricators								
MAXI DIM 25B	87	295	Metal	-	-	500	0.8	9093 0075 21
Filter/regulator								
MAXI F/R 25B-B	84	316	Metal	Semi/automatic	130	-	1.5	9093 0075 51
Filter/regulator+lubricator								
MAXI F/RD 25B-B	82	244	Metal	Semi/automatic	130	500	2.8	9093 0075 81
MAXI FRD 25B-B	81	209	Metal	Semi/automatic	130	500	3.3	9093 0076 01

^a 8 bar inlet pressure, 1 bar pressure drop.

NOTE: **Economical air flow:** 8 bar inlet pressure, 6.3 bar outlet pressure, 0.2 bar pressure drop.

Maximum air flow: 10 bar inlet pressure, 6.3 bar outlet pressure, 1 bar pressure drop.

All separate units, mounting brackets, assembly kits and pressure gauges need to be ordered separately. The MAXI F/RD and FRD units are delivered complete with mounting bracket, assembly kit and pressure gauge.

Optional Accessories

Common accessories

Designation	Ordering No.			
	MINI-K	MINI-B	MIDI OPTIMIZER	MAXI-B
Mounting bracket kit	9090 1902 00	9092 0063 01	9093 0022 01	9093 0076 15
Assembly kit	9090 1901 90	9092 0062 71	9093 0022 02	9093 0076 31

Are included in combination units (FD, FTD, F/RD and FRD)

Common accessories have to be ordered separately for separate units.

Filter (FIL) accessories (30 µm filter element is included with all filters)

Designation	Ordering No.			
	MINI-K	MINI-B	MIDI OPTIMIZER	MAXI-B
Filter element				
30 µm	9090 1898 00	9092 0063 31	9093 0023 04	9093 0076 61
5 µm		9092 0063 61	9093 0023 05	9093 0076 71
Bowl guard		9092 0063 91		

Regulator (REG) accessories

Designation	Ordering No.			
	MINI-K	MINI-B	MIDI OPTIMIZER	MAXI-B
Pressure gauge				
0-10 bar				
∅ 40 mm	9090 1907 00	9090 1907 00		
∅ 50 mm		9090 1172 00	9090 2052 00	
Metal housing			9090 2052 01	
0-16 bar				
∅ 49 mm			9090 0239 00	9090 0239 00
∅ 50 mm		9090 1657 00		
Panel mounting pressure gauge				
0-10 bar				
∅ 50 mm		9090 1173 00	9090 1173 00	
0-16 bar				
∅ 63 mm				9093 0076 43
Key lock for regulator -LP		9092 0074 11	9092 0074 11	9092 0074 11

Pressure gauge 0-10 bar is included in the combination units (F/RD and FRD)

Pressure gauge has to be ordered separately for separate units.

Lubricator (DIM) accessories

Designation	Ordering No.				
	MINI-K	MINI-B	MIDI Optimizer		MAXI-B
			MIDI 1/2"	MIDI 3/4"	
Air distribution block kit	9090 1900 90	9092 0064 51	9093 0022 03	9093 0022 04	9093 0076 41
Bowl guard		9092 0063 91			
Glass sight dome		9090 1121 00			9090 1873 00

FRL stand

Designation	Ordering No.
Suits all models	9090 2101 00

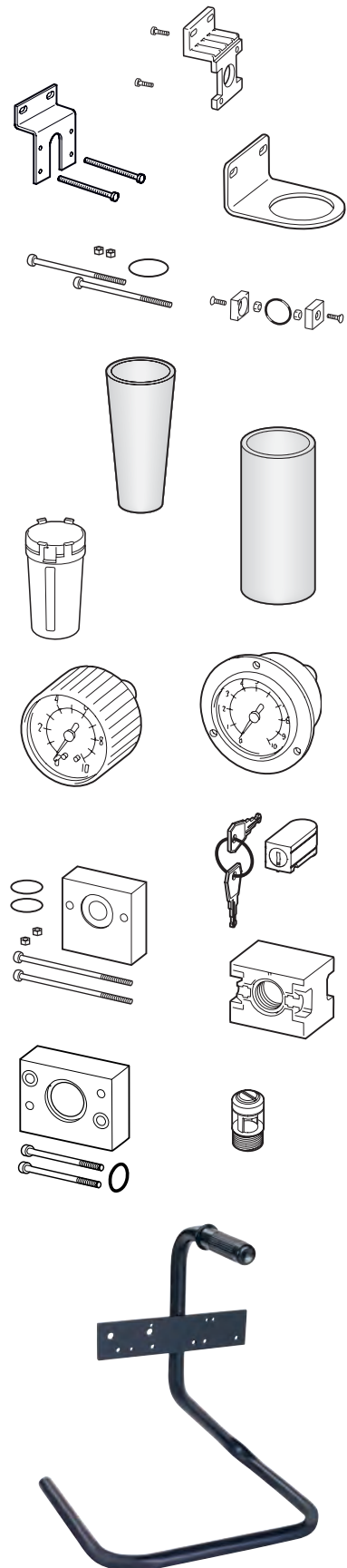

Optimizer air tool oil

Atlas Copco Optimizer air tool oil is a white, oil based lubricant for pneumatic tools. It has excellent antiwear properties and contains additives preventing oxidation and foaming. Optimizer air tool oil provides a better working environment, compared to conventional mist lubrication oils and is recommended when stringent demands are placed on the working environment.

- Provides a better working environment.
- Excellent antiwear properties.
- Minimizes wear on components.



Technical Data

Temperature range	-25°C to +70°C
Density at 15°C	869 kg/m ³
Viscosity at 40°C	22 mm ² /s
Pour point	-48°C
Flash point COC	>170°C

Model	Ordering No.
Optimizer 0.5 liter	9090 0000 02
Optimizer 1 liter	9090 0000 04
Optimizer 4 liter	9090 0000 06

Single point lubricator DOSOL

Accurate lubrication for tools in intermittent service.

The Atlas Copco DOSOL system for direct lubrication is based on an injector pump which meters out the oil in exact doses, actuated by pulses of compressed air. The oil dosage can be regulated from a fraction of a drop to a full drop.

- **Exact amount** – Precision injector, adjustable for exact amount of oil.
- **Oil directly at the tool** – The oil is conveyed through a capillary tube directly to the lubrication point.

A single-point lubricator (SPL) consists of an injector pump fitted to a valve body, converting interruptions in compressed air flow into pulses. In the majority of cases, an oil bowl is fitted on each lubricator.

Every DOSOL SPL unit can be finely tuned to inject from 1 to 1/10 of a drop of oil in 40 steps (30 to 3 mm³). Every DOSOL SPL unit includes as standard a counter with a switch that allows the lubricator to operate every first, fifth or tenth tool cycle.

The adjusting knob features a positive stop at both maximum and minimum settings, which means that a zero setting is not possible.

The preset quantity of oil is supplied to the tool through a small-bore nylon tube inside the air hose. 7.5 m of oil-filled nylon tubing is included as standard.



Multiple-point lubricator DOSOL

For supplying lubricant to an unlimited number of lubrication points on a machine or in a pneumatic system.

The DOSOL multiple-point lubricator (MPL) consists of a number of JECT 01 oil metering pumps assembled into a "package" with a common BASE baseplate. A stack may contain up to ten JECT 01 units. Several such assemblies may be used together.

- All oil pumps are supplied with oil via the BASE from an oil container or central oil reservoir. A line for pneumatic signals from the equipment to be lubricated is also connected to the BASE.
- The lubricant is conveyed through small-bore nylon tubing which should be ended with check valves.
- With the TEN counter the lubricator can be actuated every first, fifth or tenth tool cycle.

Every DOSOL MPL unit can be finely tuned to inject from 1 to 1/10 drop of oil in 40 steps (30 to 3 mm³). This helps to minimize the oil dose. The adjusting knob features a positive stop at both maximum and minimum settings, which means that zero setting is not possible.

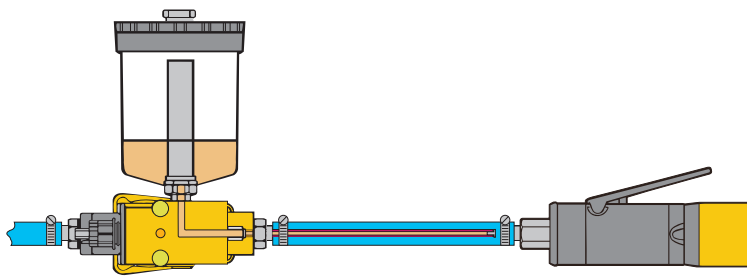

Single-point lubricator, DOS

Model	Connection thread BSP in	Air flow l/s		Working pressure bar		Temperature range °C		Ordering No.
		min	max ^a	min	max	min	max	
DOS 15B-C ^b	1/2	2.3	45	3.2	10	-30°	+60°	8202 4201 73
DOS 15B-CR ^c	1/2	2.3	45	3.2	10	-30°	+60°	8202 4202 72
DOS 20B-C ^b	3/4	2.3	53	3.2	10	-30°	+60°	8202 4201 81
DOS 20B-CR ^c	3/4	2.3	53	3.2	10	-30°	+60°	8202 4202 80

^a At 6 bar and DP = 0.2 bar.

^b With counter and 7.5 m oil-filled nylon tubing.

^c With 0.3 l oil container counter and 7.5 m oil-filled nylon tubing.

Optional Accessories

FOR SINGLE POINT LUBRICATOR DOSOL

Designation	Ordering No.
Nylon tubing 3.2 mm outside diameter	
7.5 m, oil-filled	9090 1418 00
7.5 m, without oil	9090 1419 00
100 m, with oil	9090 1420 00
Barbed nipple for joining of 3.2 mm tubes	9090 1423 00
Check valve for outer end of nylon tubing, dia ext. 3.2 mm	9090 2050 00

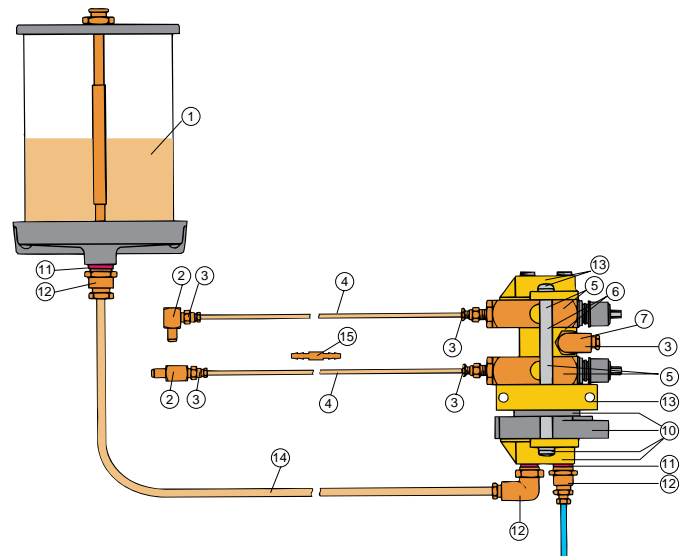

NOTE: When the counter TEN is used in MPL installations an intermediate, black plastic part is used (supplied with all TEN counters) between BASE and TEN.

FOR MULTI POINT LUBRICATOR DOSOL

Multiple-point lubricator, BASE, JECT 01

Designation		BSP in	Ordering No.
BASE baseplate	Plate	Oil port	1/4
		Air port	1/4
	Clamp	Oil port	1/4
		Air port	1/4
JECT 01 oil pump	Oil delivery port	1/8	8202 4203 10

TEN-counter

When lubricating equipment with a very low air consumption or very short time in operation it may be difficult to set a sufficiently small dose of oil. In such cases a counter is connected underneath the base plate BASE. The oil pumps will then be actuated only on each, every fifth or every tenth air pulse. The air signal is connected to the clamp underneath the counter. Ordering No. 8202 4206 03

Side-ported air block kit

If all pumps are not to be actuated simultaneously, a signal block is installed between the oil pumps in the stack. The pumps below the signal block will then be actuated via the base plate BASE and those above it from a separate signal via the signal block.

Ordering No. 8202 4206 03

Ref No. in figure	Designation	Ordering No.
1	Oil container	
	0.3 l for direct mounting	9090 1415 00
	0.95 l for wall mounting (1/4" BSP female)	9090 1416 00
	1.9 l for wall mounting (1/4" BSP female)	9090 1417 00
2	Check valve	
	1/8" BSPT 90° elbow male x 1/8" BSP female	9090 1427 00
	1/8" BSPT, straight male x 1/8" BSP female	9090 1426 00
3	Male adapter 1/8" BSPT, straight for tube outer diameter 3.2 mm	9090 1425 00
4	Capillary tubing	
	7.5 m, outer dia. 3.2 mm prefilled with oil	9090 1418 00
	7.5 m, outer dia. 3.2 mm without oil	9090 1419 00
	100 m, outer dia. 3.2 mm with oil	9090 1420 00
5	JECT 01 kit ^a	8202 4203 10
6	Side-ported air block kit	9090 1424 00
7	Fiber packing for 1/8" BSP	0657 5742 00
10	Counter TEN kit	8202 4206 03
11	Fiber packing for 1/4" BSP	0657 5764 00
12	Male adapter 1/4" BSP, straight for tube outer diameter 8 mm	9090 0715 00
13	BASE kit	8202 4205 04
14	Nylon tube, outer diameter 8 mm (sold by the meter)	9030 0060 00
15	Barbed nipple for joining of nylon tubes outer diameter 3.2 mm	9090 1423 00
16	Nylon tube outer diameter 5 mm (sold by the meter)	9030 0059 00

^a With high temperature Viton seals 8202 4203 15.

Simply the best choice!

Whenever tools or pneumatic equipment need to be changed, or you need to make quick connections of hoses to an air outlet, Atlas Copco couplings are simply the best choice.

Energy efficiency

All Atlas Copco couplings are designed for a minimum pressure drop to reduce energy consumption.

Productivity

Exceptionally high air flow will guarantee full power in the tools.

Quality

The bodies of the couplings are made of hardened steel with a no-leakage design for long service life and heavy duty applications.

Ergonomics

Compact dimensions and low weight.

Safety

ErgoQIC and QIC S are vented safety versions to minimize the risk of sudden

component separation and sound bang. The safety features are according to EN 983 and ISO 4414.

The range

The range consists of 23 different types, ErgoQIC 08/E/US/ARO, ErgoQIC 10/ASIA/US/AC, ErgoQIC 15E/US, QIC 08/S, QIC 10/S/E/SE/ASIA/US, QIC 15/S/SE/US and CLAW. The ErgoQIC system is a ball valve coupling with a safety feature offering a higher flow than ordinary coupling systems. The QIC system is a normal quick coupling system with high air flow. The QIC S and QIC SE are quick couplings with a safety function. The Claw coupling is a large bore claw coupling system offering a very high air flow.

For assembly tools, riveting hammers and drills it is recommended that

a smaller sized coupling such as QIC 10/S/E/SE, ErgoQIC 08/E and ErgoQIC 10US is used, but for assembly tools and drills with higher air consumption than 20 l/s it is recommended that QIC 15/S/SE, ErgoQIC 10 or ErgoQIC 15US are used. For grinders and percussive tools it is recommended that the bigger sized couplings QIC 15/S/SE and ErgoQIC 10 and Claw are used. For smaller grinders with air consumption below 10 l/s ErgoQIC 08/E, QIC 10/S/E/SE and ErgoQIC 10US can be used.

Pocket coupling selector available, Ordering No. 9833 1648 08

Selection Guide

Standard Type Market	GLOBAL		EU standard		ISO 6150-B (former US)			ARO 210	EU	EU	ASIA
			7.6 (7.4)	10.4	1/4" Benelux, France, US, Norway, Switzerland	3/8"	1/2"	Benelux, US	Australia		Italy, SA
Atlas Copco ErgoQIC	08	10	08E	15E	08US	10US	15US	08AR	10AC		10 ASIA
Atlas Copco QIC			10E	15E	08	10US	15US		10	15	10 ASIA
Atlas Copco QIC Safety			10SE	15SE	08S				10S	15S	
CEJN			320	410	310	430	550	300			315
Oetiker			SC C		SC B1	SC E	SC H	SC A1			SC D
Tema			1600	1700	1400				1650	1750	
Rectus			25/26	27	23/24	30	37	14/22	33	34	13
Prevost			ESC/ERC07		IRC/ISC06	IRC/ISC08	ISG 11	ARM06			ORG
Nitto Kohki											20/30/40
ARO					102	103/203	104/204	210			
Amflo					C20B	C26	C10	C38			
Bosch			7.2								
Parker				55	30 / B23	25F	17	50 / B53			
Foster					3003	4404	5205	210			
Camozzi			508/5180								
Dynaquip					1/4"	3/8"					
EWO			x								
Festo			KD								
Gromelle					600	900		GD16600			
Hansen					22/3000	400/4000	500/5000	20/4 RO			
Ingersoll Rand			7S7		A2/MS/102	A3/103/203	A4/104/204	210/AN6/AS6			
Kaeser			x								
Legris			25/26	27	23/24	30		14/22			13
Tomco					180	4000	5000	100			

Atlas Copco Global standard

ErgoQIC 08

The ErgoQIC 08 is a full flow quick coupling with no air restriction inside the coupling. It is suitable for assembly tools, drills and small grinders. Upgrading any air system with ErgoQIC 08 will give the benefits of productivity and energy efficiency.

- Full flow coupling.
- Ergonomic design, small size and low weight.
- Strong and durable.
- Safety feature according to EN 983 / ISO 4414.
- Main market: Global.



Technical Data

Max flow capacity 29 l/s (0.5 bar ΔP)
 Economical air flow 18 l/s (0.2 bar ΔP)
 Max working pressure 16 bar
 Temperature range -10°C to +70°C

Flow chart. ErgoQIC 08 M15 and ErgoNIP 08 M10

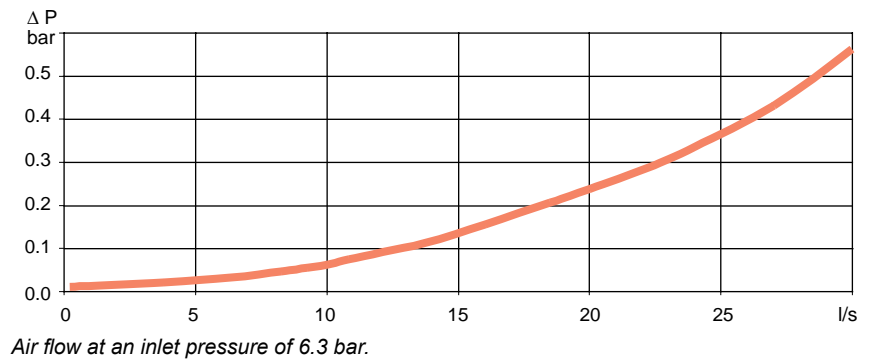

ErgoQIC 08 and ErgoNIP 08, 18 l/s (recommended air flow at 6.3 bar pressure)

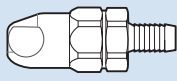
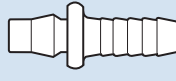
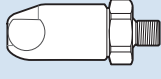
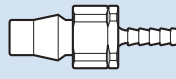
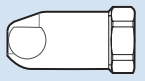
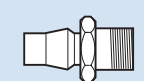
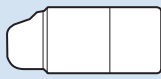
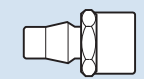
Connection type	Coupling ErgoQIC 08	Ordering No.	Size		Connection type	Nipple ErgoNIP 08	Ordering No.	Size	
			mm	in				mm	in
H – Hose 	H06	8202 1110 04	6.3	1/4	H – Hose 	H05	8202 1210 33	5	3/16
	H08	8202 1110 12	8	5/16		H06	8202 1210 37	6.3	1/4
	H10	8202 1110 38	10	3/8		H08	8202 1210 45	8	5/16
	H13	8202 1110 40	12.5	1/2		H10	8202 1210 52	10	3/8
M – Male 	M08	8202 1110 61	1/4 BSP	SH – Safety Hose^a 	SH06	8202 1210 39	6.3	1/4	
	M10	8202 1110 79	3/8 BSP		SH08	8202 1210 47	8	5/16	
	M15	8202 1110 87	1/2 BSP		SH10	8202 1210 50	10	3/8	
						SH13	8202 1210 55	12.5	1/2
F – Female 	F08	8202 1110 90	1/4 BSP	M – Male 	M06	8202 1210 03	1/8 BSP		
	F10	8202 1110 95	3/8 BSP		M08	8202 1210 11	1/4 BSP		
	F15	8202 1110 96	1/2 BSP		M10	8202 1210 29	3/8 BSP		
						M15	8202 1210 31	1/2 BSP	
Protective cover		9090 1940 00							
				F – Female 	F08	8202 1210 60	1/4 BSP		
					F10	8202 1210 62	3/8 BSP		

^a For joining hoses longer than 3 meters.

Atlas Copco Global standard

ErgoQIC 10

The ErgoQIC 10 is a full flow coupling with no air restriction inside the coupling. It is suitable for assembly tools, drills and grinders. Upgrading any air system with ErgoQIC 10 will give the benefits of productivity and energy efficiency.

- Extreme full flow coupling.
- Strong and durable.
- Minimized connection force.
- Safety feature according to EN 983 / ISO 4414.
- Main market: Global.



Nipple profile

Technical Data

Max flow capacity 60 l/s (0.5 bar ΔP)
 Economical air flow 40 l/s (0.2 bar ΔP)
 Max working pressure 16 bar
 Temperature range -10°C to +70°C

Flow chart. ErgoQIC 10 M15 and ErgoNIP 10 M15

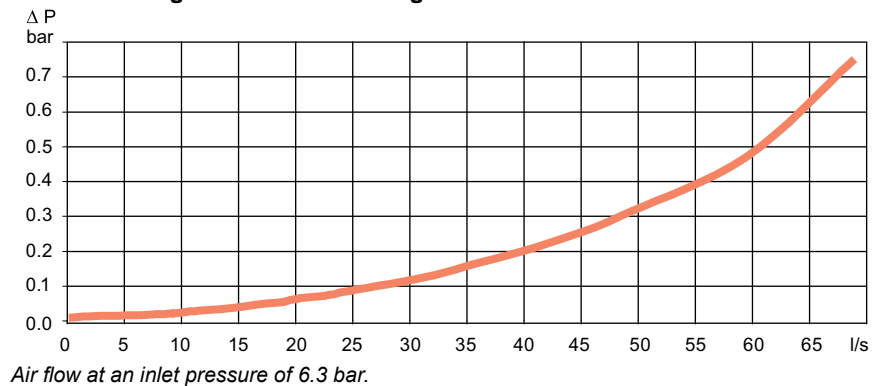

ErgoQIC 10 and ErgoNIP 10, 40 l/s (recommended air flow at 6.3 bar pressure)

Connection type	Coupling ErgoQIC 10	Ordering No.	Size		Connection type	Nipple ErgoNIP 10	Ordering No.	Size	
			mm	in				mm	in
	H06	8202 1120 30	6.3	1/4		H06	8202 1220 35	6.3	1/4
	H08	8202 1120 40	8	5/16		H08	8202 1220 43	8	5/16
	H10	8202 1120 02	10	3/8		H10	8202 1220 50	10	3/8
	H13	8202 1120 10	12.5	1/2		H13	8202 1220 68	12.5	1/2
	H16	8202 1120 50	16	5/8		H16	8202 1220 76	16	5/8
	H20	8202 1120 60	19	3/4		H20	8202 1220 77	19	3/4
	M08	8202 1120 85	1/4	BSP		SH06	8202 1220 37	6.3	1/4
	M10	8202 1120 93	3/8	BSP		SH08	8202 1220 45	8	5/16
	M15	8202 1120 97	1/2	BSP		SH10	8202 1220 52	10	3/8
	M20	8202 1120 98	3/4	BSP		SH13	8202 1220 70	12.5	1/2
	M25	8202 1120 99	1	BSP		SH16	8202 1220 74	16	5/8
	F08	8202 1121 00	1/4	BSP		M08	8202 1220 01	1/4	BSP
	F10	8202 1121 05	3/8	BSP		M10	8202 1220 19	3/8	BSP
	F15	8202 1121 10	1/2	BSP		M15	8202 1220 27	1/2	BSP
	Protective cover	9090 1931 00					F08	8202 1220 84	1/4
				F10	8202 1220 86		3/8	BSP	
				F15	8202 1220 88		1/2	BSP	

^a For joining hoses longer than 3 meters.

Eurostandard 7.6 (7.4)

ErgoQIC 08E

The ErgoQIC 08E is a full flow quick coupling with no air restriction inside the coupling. It is suitable for assembly tools, drills and small grinders. Upgrading any air system using Eurostandard nipples with ErgoQIC 08E couplings will give the benefits of productivity and energy efficiency.

- Full flow coupling.
- Ergonomic design, small size and low weight.
- Strong and durable.
- Safety feature according to EN 983 / ISO 4414.
- Main market: Europe.

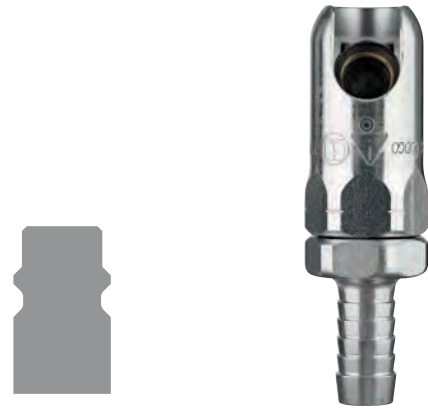

Nipple profile



Technical Data

Max flow capacity 38 l/s (0.5 bar ΔP)
 Economical air flow 24 l/s (0.2 bar ΔP)
 Max working pressure 16 bar
 Temperature range -10°C to +70°C

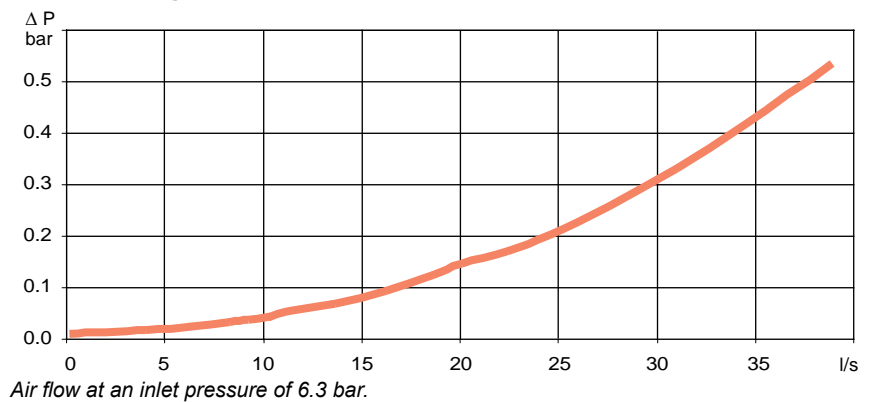
Flow chart. ErgoQIC 08E and NIP EU 7.6

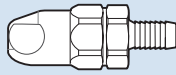

ErgoQIC 08E and NIP EU 7.6, 25 l/s (recommended air flow at 6.3 bar pressure)

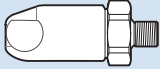
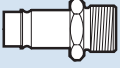
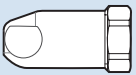
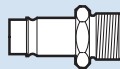
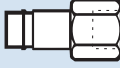
Connection type	Coupling ErgoQIC 08E		Size		Connection type	Nipple NIP EU 7.6		Size	
		Ordering No.	mm	in			Ordering No.	mm	in
H – Hose 	H06	8202 1106 00	6.3	1/4	H – Hose 	H05	8202 1204 00	5	3/16
	H08	8202 1106 01	8	5/16		H06	8202 1204 05	6.3	1/4
	H10	8202 1106 02	10	3/8		H08	8202 1204 10	8	5/16
	H13	8202 1106 03	12.5	1/2		H10	8202 1204 15	10	3/8
M – Male thread 	M08	8202 1106 04	1/4	BSP	M – Male thread 	M06	8202 1204 25	1/8	BSP
	M10	8202 1106 05	3/8	BSP		M08	8202 1204 30	1/4	BSP
	M15	8202 1106 06	1/2	BSP		M10	8202 1204 35	3/8	BSP
F – Female 	F08	8202 1106 07	1/4	BSP	MT – Male taper thread 	MT08	8202 1204 40	1/4	BSPT
	F10	8202 1106 08	3/8	BSP		MT10	8202 1204 45	3/8	BSPT
	F15	8202 1106 09	1/2	BSP		MT15	8202 1204 50	1/2	BSPT
					F – Female 	F08	8202 1204 55	1/4	BSP
						F10	8202 1204 60	3/8	BSP

Eurostandard 7.6 (7.4)

QIC 10E

The QIC 10E coupling is easy to handle and suitable for assembly tools and drills. The QIC 10E is compatible with eurostandard nipples. QIC 10E has a wide range of connections available.

- High flow coupling.
- One-hand operation.
- Low connection force.
- Main market: Europe.





Technical Data

Max flow capacity 32 l/s (0.5 bar ΔP)
 Economical air flow 20 l/s (0.2 bar ΔP)
 Max working pressure 16 bar
 Temperature range -20°C to +80°C

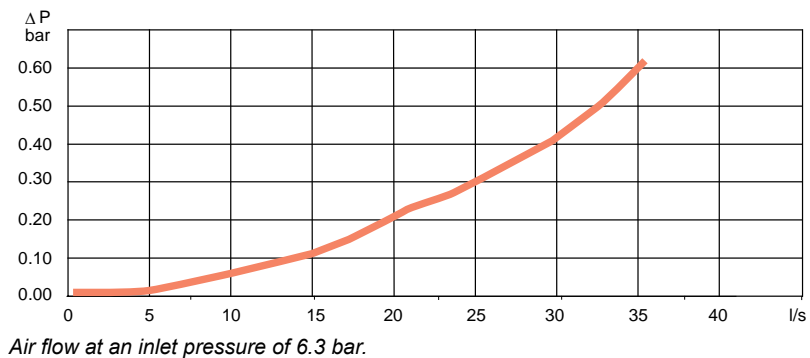
Flow chart. QIC 10E M10 and NIP EU 7.6

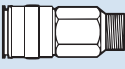
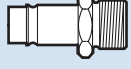
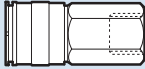
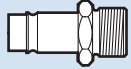
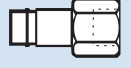

QIC 10E and NIP EU 7.6, 20 l/s (recommended air flow at 6.3 bar pressure)

Connection type	Coupling QIC 10E	Ordering No.	Size		Connection type	Nipple NIP EU 7.6	Ordering No.	Size	
			mm	in				mm	in
H – Hose 	H06	8202 1303 80	6.3	1/4	H – Hose 	H05	8202 1204 00	5	3/16
	H08	8202 1303 81	8	5/16		H06	8202 1204 05	6.3	1/4
	H10	8202 1303 82	10	3/8		H08	8202 1204 10	8	5/16
	H13	8202 1303 83	13	1/2		H10	8202 1204 15	10	3/8
						H13	8202 1204 20	12.5	1/2
MT – Male taper thread 	MT08	8202 1303 84	1/4 BSPT		M – Male thread 	M06	8202 1204 25	1/8 BSP	
	MT10	8202 1303 85	3/8 BSPT			M08	8202 1204 30	1/4 BSP	
	MT15	8202 1303 86	1/2 BSPT			M10	8202 1204 35	3/8 BSP	
F – Female 	F08	8202 1303 87	1/4 BSP	MT – Male taper thread 	MT08	8202 1204 40	1/4 BSPT		
	F10	8202 1303 88	3/8 BSP		MT10	8202 1204 45	3/8 BSPT		
						MT15	8202 1204 50	1/2 BSPT	
				F – Female 	F08	8202 1204 55	1/4 BSP		
					F10	8202 1204 60	3/8 BSP		

Eurostandard 7.6 (7.4)

QIC 10SE

The QIC 10SE safety coupling is easy to handle and suitable for assembly tools and drills. The QIC 10SE is compatible with eurostandard nipples. QIC 10SE has a wide range of connections available.

- High flow coupling.
- One-hand operation.
- Safety feature according to EN 983 / ISO 4414.
- Main market: Europe.

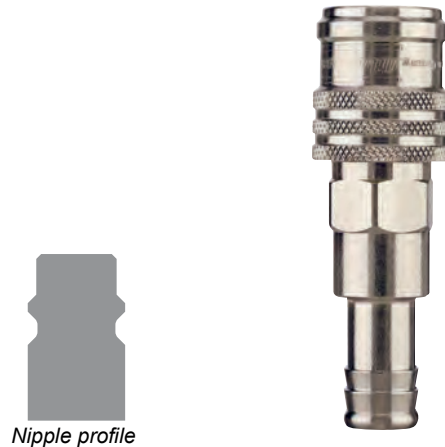

Technical Data





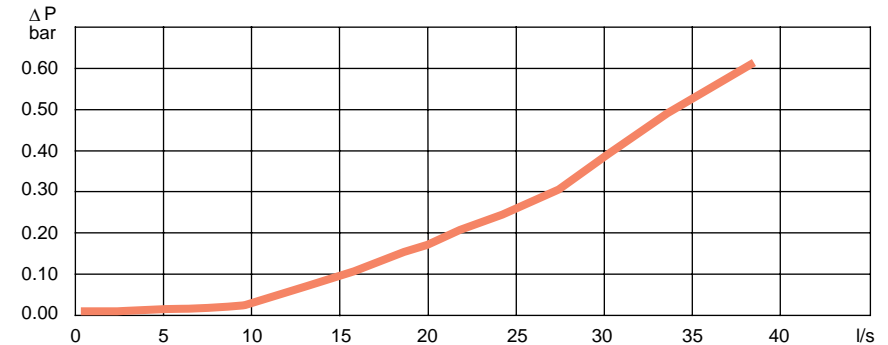

Max flow capacity 34 l/s (0.5 bar ΔP)
 Economical air flow 22 l/s (0.2 bar ΔP)
 Max working pressure 16 bar
 Temperature range -20°C to +80°C

Flow chart. QIC 10SE M10 and NIP EU 7.6

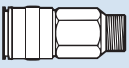
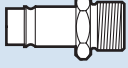

Air flow at an inlet pressure of 6.3 bar.

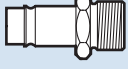
QIC 10SE and NIP EU 7.6, 22 l/s (recommended air flow at 6.3 bar pressure)

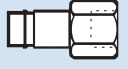
Connection type	Coupling QIC 10SE		Size		Connection type	Nipple NIP EU 7.6		Size	
		Ordering No.	mm	in			Ordering No.	mm	in
H – Hose 	H06	8202 1303 60	6.3	1/4	H – Hose 	H05	8202 1204 00	5	3/16
	H08	8202 1303 61	8	5/16		H06	8202 1204 05	6.3	1/4
	H10	8202 1303 62	10	3/8		H08	8202 1204 10	8	5/16
	H13	8202 1303 63	12.5	1/2		H10	8202 1204 15	10	3/8
M – Male thread 	M08	8202 1303 64	1/4	BSP	M – Male thread 	M06	8202 1204 25	1/8	BSP
	M10	8202 1303 65	3/8	BSP		M08	8202 1204 30	1/4	BSP
	M15	8202 1303 66	1/2	BSP		M10	8202 1204 35	3/8	BSP
MT – Male taper thread 	MT15	8202 1303 67	1/2	BSPT	MT – Male taper thread 	MT08	8202 1204 40	1/4	BSPT
						MT10	8202 1204 45	3/8	BSPT
						MT15	8202 1204 50	1/2	BSPT
F – Female 	F08	8202 1303 68	1/4	BSP	F – Female 	F08	8202 1204 55	1/4	BSP
	F10	8202 1303 69	3/8	BSP		F10	8202 1204 60	3/8	BSP
	F15	8202 1303 70	1/2	BSP					

Euro standard 10.4

ErgoQIC 15E

The ErgoQIC 15E is a full flow coupling with no air restriction inside the coupling suitable for large air consuming assembly tools, drills and grinders. Upgrading any air system with ErgoQIC 15E will give the benefit of productivity and energy efficiency.

- Extreme full flow coupling.
- Strong and durable.
- Minimized connection force.
- Safety feature according to EN 983 / ISO 4414.
- Main market: Europe.



Technical Data





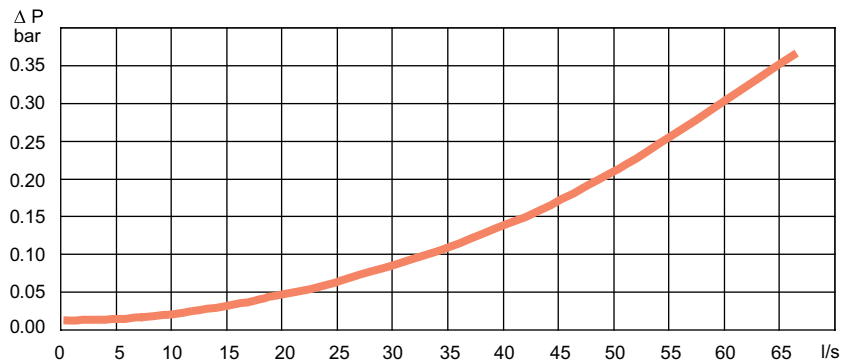

Max flow capacity 76 l/s (0.5 bar ΔP)
 Economical air flow 49 l/s (0.2 bar ΔP)
 Max working pressure 16 bar
 Temperature range -20°C to +80°C

Flow chart. ErgoQIC 15E and NIP 15E

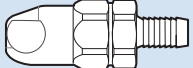

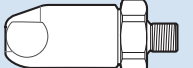
Air flow at an inlet pressure of 6.3 bar.

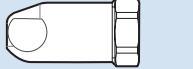
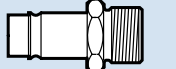
ErgoQIC 15E and NIP 15E, 49 l/s (recommended air flow at 6.3 bar pressure)

Connection type	Coupling ErgoQIC 15E	Ordering No.	Size		Connection type	Nipple NIP 15E	Ordering No.	Size		
			mm	in				mm	in	
	H10	8202 1106 50	10	3/8		H06	8202 1253 00	6.3	1/4	
	H13	8202 1106 51	12.5	1/2		H08	8202 1253 05	8	5/16	
	H16	8202 1106 52	16	5/8		H10	8202 1253 10	10	3/8	
	H20	8202 1106 53	19	3/4		H13	8202 1253 15	12.5	1/2	
	M10	8202 1106 60	3/8	BSP			M10	8202 1253 25	3/8	BSP
	M15	8202 1106 61	1/2	BSP			M15	8202 1253 30	1/2	BSP
	M20	8202 1106 62	3/4	BSP	M20		8202 1253 34	3/4	BSP	
	M25	8202 1106 63	1	BSP						
	F10	8202 1106 70	3/8	BSP		MT08	8202 1253 35	1/4	BSPT	
	F15	8202 1106 71	1/2	BSP		MT10	8202 1253 40	3/8	BSPT	
						MT15	8202 1253 45	1/2	BSPT	
						F08	8202 1253 50	1/4	BSP	
				F10		8202 1253 55	3/8	BSP		
				F15		8202 1253 60	1/2	BSP		
				F20		8202 1253 63	3/4	BSP		

Euro standard 10.4

QIC 15E

The QIC 15E quick coupling is suitable for assembly tools, grinders and drills. The QIC 15E has a wide range of connections available and it is interchangeable with eurostandard nipples.

- Exceptionally high flow.
- One-hand operation.
- Strong and durable.
- Main market: Europe.



Nipple profile



Technical Data



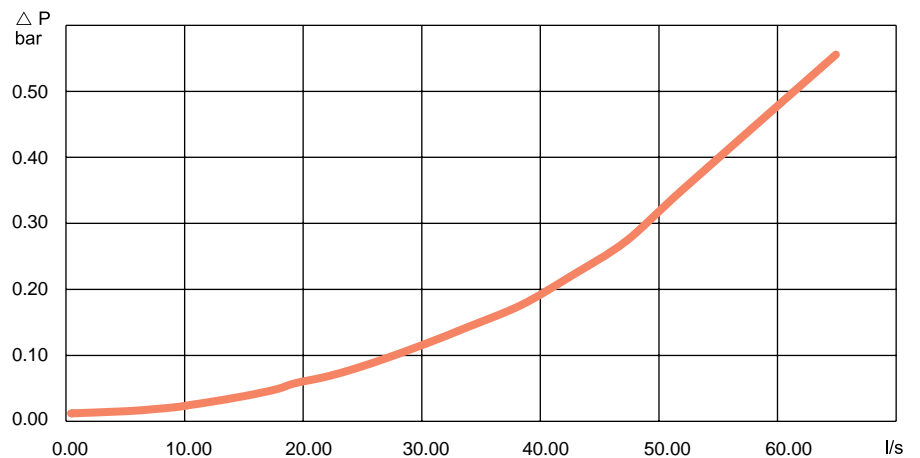

Max flow capacity 62 l/s (0.5 bar ΔP)
 Economical air flow 40 l/s (0.2 bar ΔP)
 Max working pressure 10 bar
 Temperature range -20°C to +80°C

Flow chart. QIC 15E and NIP EU 10.4

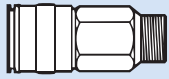
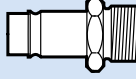

Air flow at an inlet pressure of 6.3 bar.

QIC 15E and NIP EU 10.4, 40 l/s (recommended air flow at 6.3 bar pressure)

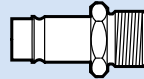
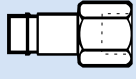
Connection type	Coupling QIC 15E	Ordering No.	Size		Connection type	Nipple NIP EU 10.4	Ordering No.	Size	
			mm	in				mm	in
H – Hose 	H10	8202 1304 81	10	3/8	H – Hose 	H06	8202 1253 00	6.3	1/4
	H13	8202 1304 82	12.5	1/2		H08	8202 1253 05	8	5/16
	H16	8202 1304 90	16	5/8		H10	8202 1253 10	10	3/8
	H20	8202 1304 83	19	3/4		H13	8202 1253 15	12.5	1/2
MT – Male taper thread 	MT10	8202 1304 84	3/8	BSPT	M – Male 	M10	8202 1253 25	3/8	BSP
	MT15	8202 1304 85	1/2	BSPT		M15	8202 1253 30	1/2	BSP
	MT20	8202 1304 86	3/4	BSPT		M20	8202 1253 34	3/4	BSP
F – Female 	F10	8202 1304 87	3/8	BSP	MT – Male taper thread 	MT08	8202 1253 35	1/4	BSPT
	F15	8202 1304 88	1/2	BSP		MT10	8202 1253 40	3/8	BSPT
	F20	8202 1304 89	3/4	BSP		MT15	8202 1253 45	1/2	BSPT
					F – Female 	F08	8202 1253 50	1/4	BSP
				F10		8202 1253 55	3/8	BSP	
				F15		8202 1253 60	1/2	BSP	
				F20		8202 1253 63	3/4	BSP	

Eurostandard 10.4

QIC 15SE

The QIC 15SE safety coupling is suitable for assembly tools, grinders and drills. The QIC 15SE is interchangeable with eurostandard nipples and can withstand rough handling.

- Exceptionally high flow.
- One-hand operation.
- Safety feature according to EN 983 / ISO 4414.
- Main market: Europe.



Technical Data

Max flow capacity 63 l/s (0.5 bar ΔP)
 Economical air flow 41 l/s (0.2 bar ΔP)
 Max working pressure 10 bar
 Temperature range -20°C to +80°C

Flow chart. QIC 15SE M15 and NIP 15E F15

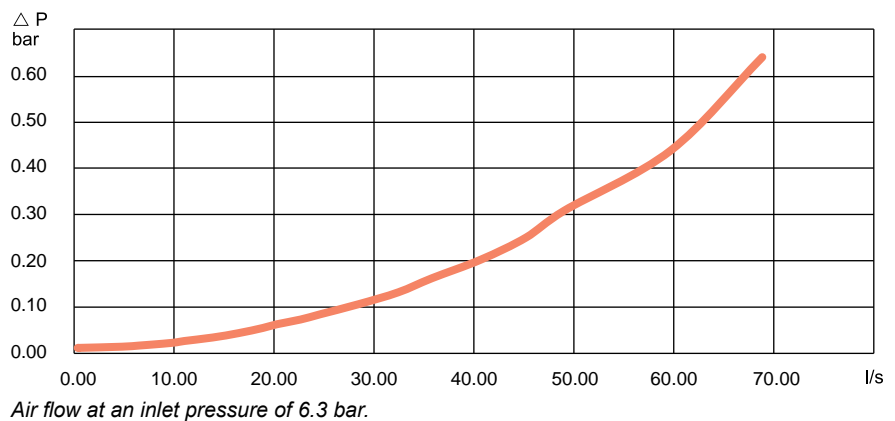

QIC 15SE and NIP 15E, 41 l/s (recommended air flow at 6.3 bar pressure)

Connection type	Coupling QIC 15SE	Ordering No.	Size		Connection type	Nipple NIP 15E	Ordering No.	Size	
			mm	in				mm	in
H – Hose 	H10	8202 1305 30	10	3/8	H – Hose 	H06	8202 1253 00	6.3	1/4
	H13	8202 1305 31	12.5	1/2		H08	8202 1253 05	8	5/16
	H16	8202 1305 32	16	5/8		H10	8202 1253 10	10	3/8
M – Male thread 	M08	8202 1305 33	1/4	BSP		H13	8202 1253 15	12.5	1/2
	M10	8202 1305 34	3/8	BSP		H16	8202 1253 20	16	5/8
	M15	8202 1305 35	1/2	BSP		H20	8202 1253 23	19	3/4
F – Female thread 	F15	8202 1305 36	1/2	BSP	M – Male thread 	M10	8202 1253 25	3/8	BSP
						M15	8202 1253 30	1/2	BSP
						M20	8202 1253 34	3/4	BSP
MT – Male taper thread 	F15	8202 1305 36	1/2	BSP	MT – Male taper thread 	MT08	8202 1253 35	1/4	BSPT
						MT10	8202 1253 40	3/8	BSPT
						MT15	8202 1253 45	1/2	BSPT
F – Female thread 	F15	8202 1305 36	1/2	BSP	F – Female thread 	F08	8202 1253 50	1/4	BSP
						F10	8202 1253 55	3/8	BSP
						F15	8202 1253 60	1/2	BSP
						F20	8202 1253 63	3/4	BSP

ISO 6150-B/US standard

ErgoQIC 08US

The ErgoQIC 08US is a full flow quick coupling with no air restriction inside the coupling suitable for assembly tools, drills and small grinders. Upgrading any air system with ErgoQIC 08US will give the benefit of productivity and energy efficiency.

- Full flow coupling.
- Ergonomic design, small size and low weight.
- Strong and durable.
- Safety feature according to EN 983 / ISO 4414.
- Main market: North America, France, Norway and Spain.

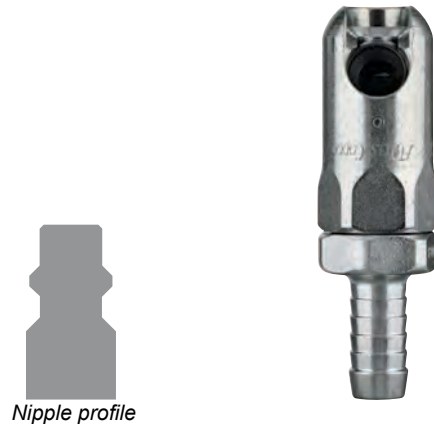



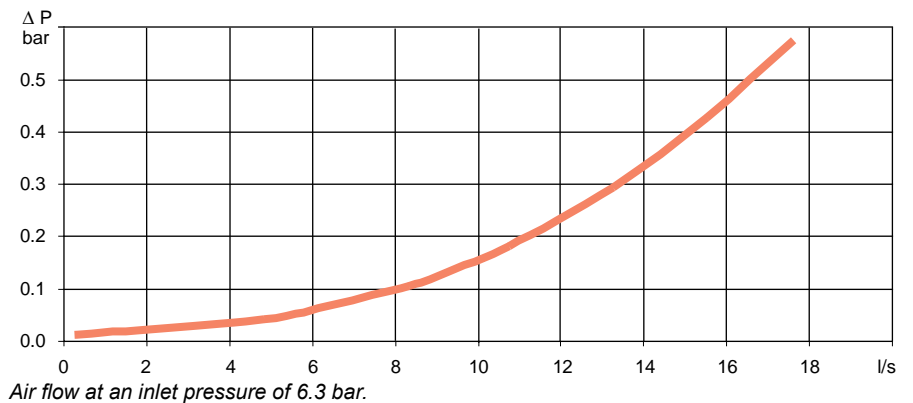

Technical Data

Max flow capacity 17 l/s (0.5 bar ΔP)
 Economical air flow 11 l/s (0.2 bar ΔP)
 Max working pressure 16 bar
 Temperature range -20°C to 80°C

Flow chart. ErgoQIC 08US and NIP 08

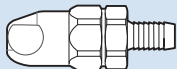
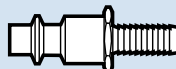

ErgoQIC 08US and NIP 08, 11 l/s (recommended air flow at 6.3 bar pressure)

Connection type	Coupling ErgoQIC 08US		Size		Connection type	Nipple NIP 08		Size	
		Ordering No.	mm	in			Ordering No.	mm	in
H – Hose 	H06	8202 1103 00	6.3	1/4	H – Hose 	H06	8202 1205 18	6.3	1/4
	H08	8202 1103 01	8	5/16		H08	8202 1205 26	8	5/16
	H10	8202 1103 02	10	3/8		H10	8202 1205 34	10	3/8
	H13	8202 1103 03	12.5	1/2		H13	8202 1208 03	12.5	1/2
M – Male 	M08	8202 1103 05	1/4	BSP	M – Male 	M06	8202 1205 42	1/8	BSP
	M10	8202 1103 07	3/8	BSP		M08	8202 1205 59	1/4	BSP
	M15	8202 1103 09	1/2	BSP		M10	8202 1205 67	3/8	BSP
F – Female 	F08	8202 1103 11	1/4	BSP	F – Female 	F06	8202 1208 10	1/8	BSP
	F10	8202 1103 13	3/8	BSP		F08	8202 1205 83	1/4	BSP
							F10	8202 1205 91	3/8

ISO 6150-B/US standard

QIC 08

The QIC 08 coupling is suitable for small screwdrivers and drills. Its lightweight, compact design makes the QIC 08 coupling easy to work with.

- High flow coupling.
- One-hand operation.
- Low connection force.
- Main market: North America, France, Norway and Spain.



Nipple profile

Technical Data

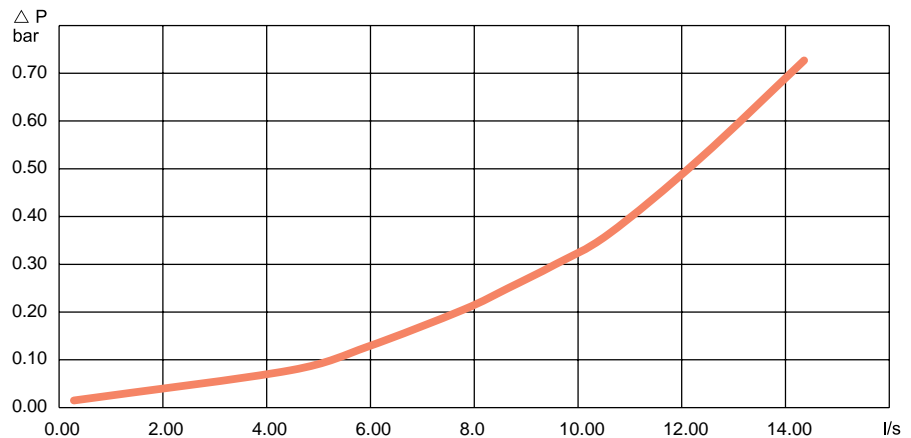

Max flow capacity	12 l/s (0.5 bar ΔP)
Economical air flow	8 l/s (0.2 bar ΔP)
Max working pressure	16 bar
Temperature range	-20°C to +80°C

Flow chart. QIC 08 M08 and NIP 08 F08



Air flow at an inlet pressure of 6.3 bar.

QIC 08 and NIP 08, 8 l/s (recommended air flow at 6.3 bar pressure)

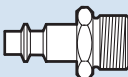
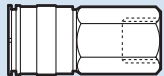
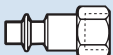
Connection type	Coupling QIC 08	Ordering No.	Size		Connection type	Nipple NIP 08	Ordering No.	Size	
			mm	in				mm	in
H – Hose 	H06	8202 1300 04	6.3	1/4	H – Hose 	H06	8202 1205 18	6.3	1/4
	H08	8202 1300 12	8	5/16		H08	8202 1205 26	8	5/16
	H10	8202 1300 20	10	3/8		H10	8202 1205 34	10	3/8
M – Male thread 	M08	8202 1300 38	1/4	BSP	M – Male thread 	M06	8202 1205 42	1/8	BSP
	M10	8202 1300 46	3/8	BSP		M08	8202 1205 59	1/4	BSP
							M10	8202 1205 67	3/8
F – Female thread 	F08	8202 1300 53	1/4	BSP	F – Female thread 	F08	8202 1205 83	1/4	BSP
	F10	8202 1300 61	3/8	BSP		F10	8202 1205 91	3/8	BSP

ISO 6150-B/US standard

QIC 08S

The QIC 08S is a compact safety coupling suitable for small screwdrivers and drills. The light, compact design of QIC 08S couplings makes them easy to work with.

- High flow coupling.
- One-hand operation.
- Safety feature according to EN 983 / ISO 4414.
- Main market: North America, France, Norway and Spain.





Technical Data

Max flow capacity 12 l/s (0.5 bar ΔP)
 Economical air flow 8 l/s (0.2 bar ΔP)
 Max working pressure 16 bar
 Temperature range -20°C to +80°C

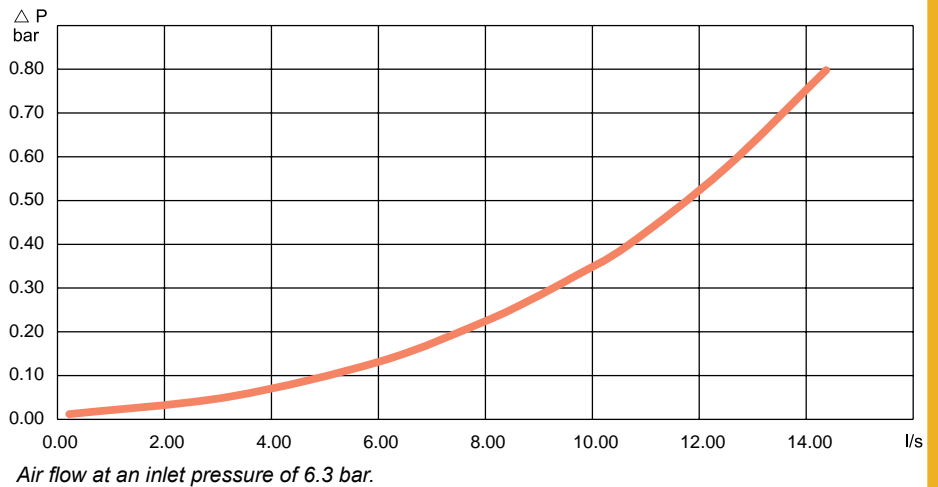
Flow chart. QIC 08S M08 and NIP 08 F08

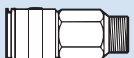
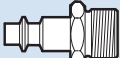
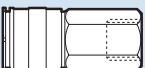
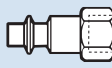

QIC 08S and NIP 08, 8 l/s (recommended air flow at 6.3 bar pressure)

Connection type	Coupling QIC 08S	Ordering No.	Size		Connection type	Nipple NIP 08	Ordering No.	Size	
			mm	in				mm	in
H – Hose 	H06	8202 1300 09	6.3	1/4	H – Hose 	H06	8202 1205 18	6.3	1/4
	H08	8202 1300 18	8	5/16		H08	8202 1205 26	8	5/16
	H10	8202 1300 28	10	3/8		H10	8202 1205 34	10	3/8
M – Male thread 	M08	8202 1300 43	1/4	BSP	M – Male thread 	M06	8202 1205 42	1/8	BSP
	M10	8202 1300 45	3/8	BSP		M08	8202 1205 59	1/4	BSP
F – Female thread 	F08	8202 1300 58	1/4	BSP	F – Female thread 	F10	8202 1205 83	3/8	BSP
	F10	8202 1300 68	3/8	BSP		F08	8202 1205 91	1/4	BSP

ISO 6150-B/US standard

ErgoQIC 10US

The ErgoQIC 10US is a full flow quick coupling with no air restriction inside the coupling suitable for assembly tools, drills and small grinders. Upgrading any air system with ErgoQIC 10US couplings will give the benefit of productivity and energy efficiency.

- Full flow coupling.
- Ergonomic design, small size and low weight.
- Strong and durable.
- Safety feature according to EN 983 / ISO 4414.
- Main market: North America, France, Norway and Spain.





Technical Data

Max flow capacity 43 l/s (0.5 bar ΔP)
 Economical air flow 27 l/s (0.2 bar ΔP)
 Max working pressure 16 bar
 Temperature range -20°C to 80°C

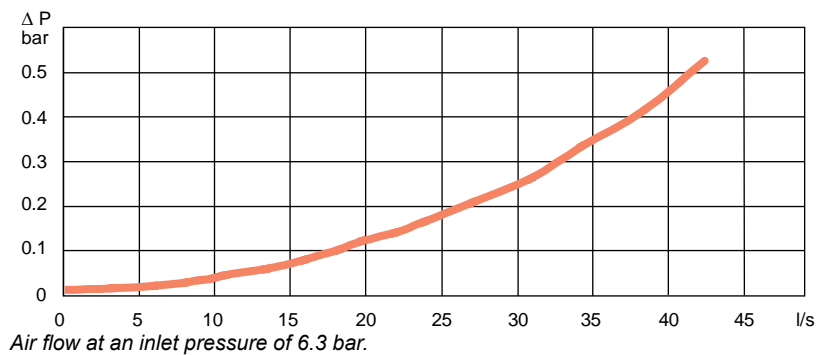
Flow chart. ErgoQIC 10US and NIP 10US

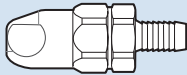

ErgoQIC 10US and NIP 10US, 27 l/s (recommended air flow at 6.3 bar pressure)

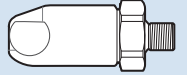
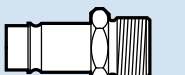
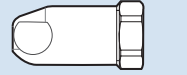
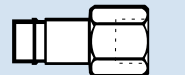
Connection type	Coupling ErgoQIC 10US		Size		Connection type	Nipple NIP 10US		Size	
		Ordering No.	mm	in			Ordering No.	mm	in
H – Hose 	H08	8202 1107 01	8	5/16	H – Hose 	H08	8202 1210 70	8	5/16
	H10	8202 1107 02	10	3/8		H10	8202 1210 71	10	3/8
	H13	8202 1107 03	12.5	1/2		H13	8202 1210 72	12.5	1/2
	H16	8202 1107 04	16	5/8		H16	8202 1210 73	16	5/8
	H20	8202 1107 05	19	3/4		H20	8202 1210 74	19	3/4
M – Male 	M08	8202 1107 07	1/4	BSP	M – Male 	M08	8202 1210 75	1/4	BSP
	M10	8202 1107 09	3/8	BSP		M10	8202 1210 76	3/8	BSP
	M15	8202 1107 11	1/2	BSP		M15	8202 1210 77	1/2	BSP
F – Female 	F08	8202 1107 13	1/4	BSP	F – Female 	F08	8202 1210 81	1/4	BSP
	F10	8202 1107 15	3/8	BSP		F10	8202 1210 82	3/8	BSP
	F15	8202 1107 17	1/2	BSP		F15	8202 1210 83	1/2	BSP

ISO 6150-B/US standard

QIC 10US

The QIC 10US quick coupling is suitable for assembly tools, drills and small grinders. The QIC 10US has a wide range of connections available and it is interchangeable with US 3/8" standard nipples.

- High flow.
- One-hand operation.
- Strong and durable.
- Main market: Global.



Nipple profile



Technical Data

Max flow capacity 19 l/s (0.5 bar ΔP)
 Economical air flow 12 l/s (0.2 bar ΔP)
 Max working pressure 10 bar
 Temperature range -20°C to 80°C

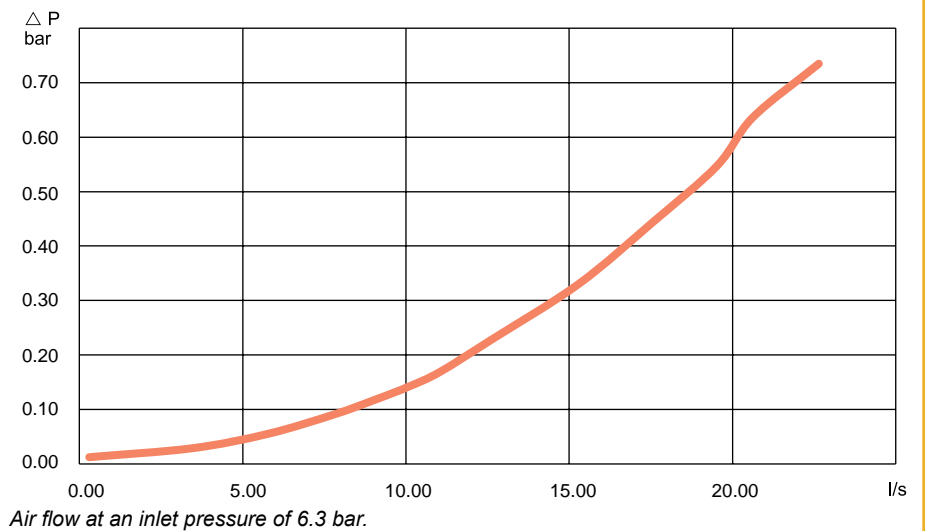
Flow chart. QIC 10US and NIP 10US

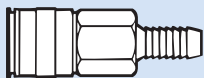

QIC 10US and NIP 10US, 12 l/s (recommended air flow at 6.3 bar pressure)

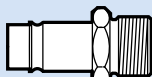
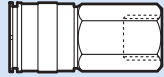
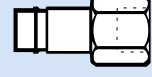
Connection type	Coupling QIC 10US	Ordering No.	Size		Connection type	Nipple NIP 10US	Ordering No.	Size	
			mm	in				mm	in
H – Hose 	H08	8202 1307 01	8	5/16	H – Hose 	H08	8202 1210 70	8	5/16
	H10	8202 1307 02	10	3/8		H10	8202 1210 71	10	3/8
	H13	8202 1307 03	12.5	1/2		H13	8202 1210 72	12.5	1/2
M – Male 	M08	8202 1307 10	1/4	BSP	M – Male 	M08	8202 1210 75	1/4	BSP
	M10	8202 1307 11	3/8	BSP		M10	8202 1210 76	3/8	BSP
	M15	8202 1307 12	1/2	BSP		M15	8202 1210 77	1/2	BSP
F – Female 	F08	8202 1307 13	1/4	BSP	F – Female 	F08	8202 1210 81	1/4	BSP
	F10	8202 1307 14	3/8	BSP		F10	8202 1210 82	3/8	BSP
	F15	8202 1307 15	1/2	BSP		F15	8202 1210 83	1/2	BSP

ISO 6150-B/US standard

ErgoQIC 15US

The ErgoQIC 15US is a full flow coupling with no air restriction inside the coupling suitable for large air consuming assembly tools, drills and grinders. Upgrading any air system with ErgoQIC 15US will give the benefit of productivity and energy efficiency.

- Extreme full flow coupling.
- Strong and durable.
- Minimized connection force.
- Safety feature according to EN 983 / ISO 4414.
- Main market: North America, France, Norway and Spain.



Nipple profile





Technical Data

Max flow capacity 77 l/s (0.5 bar ΔP)
 Economical air flow 52 l/s (0.2 bar ΔP)
 Max working pressure 16 bar
 Temperature range -20°C to +80°C

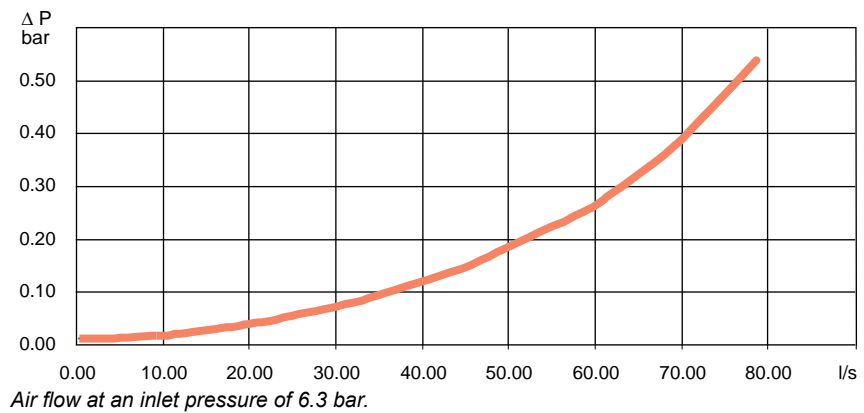
Flow chart. ErgoQIC 15US and NIP 15US

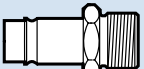
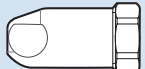
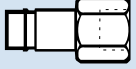

ErgoQIC 15US and NIP 15US, 52 l/s (recommended air flow at 6.3 bar pressure)

Connection type	Coupling ErgoQIC 15US	Ordering No.	Size		Connection type	Nipple NIP 15US	Ordering No.	Size	
			mm	in				mm	in
 H – Hose	H10	8202 1108 02	10	3/8	 H – Hose	H10	8202 1215 40	10	3/8
	H13	8202 1108 03	12.5	1/2		H13	8202 1215 41	12.5	1/2
	H16	8202 1108 04	16	5/8		H16	8202 1215 42	16	5/8
	H20	8202 1108 05	19	3/4		H20	8202 1215 43	19	3/4
 M – Male	M10	8202 1108 09	3/8	BSP	 M – Male	M08	8202 1215 44	1/4	BSP
	M15	8202 1108 11	1/2	BSP		M10	8202 1215 45	3/8	BSP
	M20	8202 1108 18	3/4	BSP		M15	8202 1215 46	1/2	BSP
	M25	8202 1108 20	1	BSP		M20	8202 1215 47	3/4	BSP
 F – Female	F10	8202 1108 15	3/8	BSP	 F – Female	F10	8202 1215 52	3/8	BSP
	F15	8202 1108 17	1/2	BSP		F15	8202 1215 53	1/2	BSP

ISO 6150-B/US standard

QIC 15US

The QIC 15US quick coupling is suitable for assembly tools, drills and grinders. The QIC 15US has a wide range of connections available and it is interchangeable with US 3/8" standard nipples.

- Exceptional high flow.
- One-hand operation.
- Strong and durable.
- Main market: Global.



Nipple profile





Technical Data

Max flow capacity 40 l/s (0.5 bar ΔP)
 Economical air flow 22 l/s (0.2 bar ΔP)
 Max working pressure 10 bar
 Temperature range -20°C to +80°C

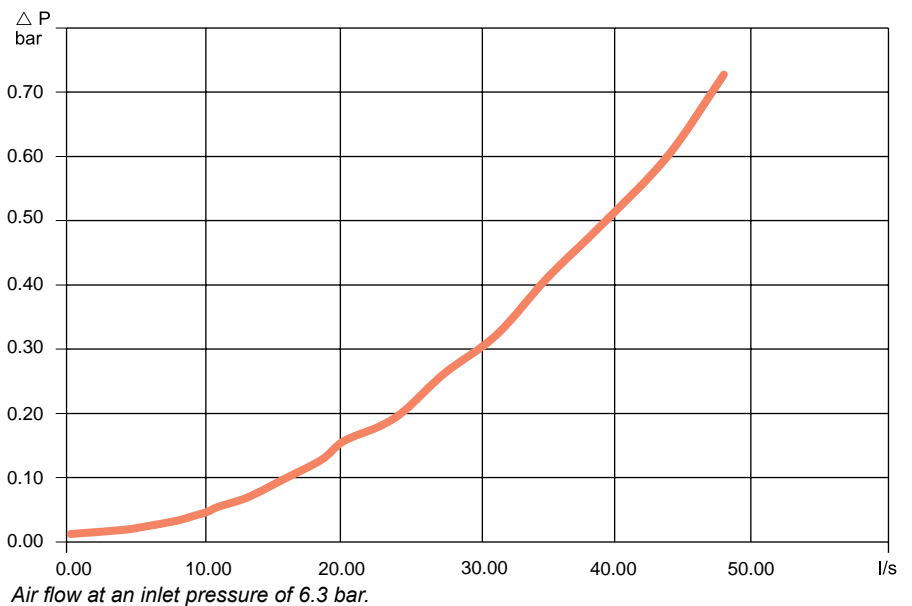
Flow chart. QIC 15US and NIP 15US

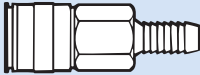

QIC 15US and NIP 15US, 22 l/s (recommended air flow at 6.3 bar pressure)

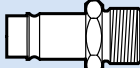
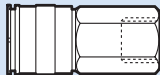
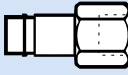
Connection type	Coupling QIC 15US	Ordering No.	Size		Connection type	Nipple NIP 15US	Ordering No.	Size	
			mm	in				mm	in
H – Hose 	H13	8202 1308 02	12.5	1/2	H – Hose 	H10	8202 1215 40	10	3/8
	H16	8202 1308 20	16	5/8		H13	8202 1215 41	12.5	1/2
	H20	8202 1308 03	19	3/4		H16	8202 1215 42	16	5/8
M – Male 	M10	8202 1308 10	3/8 BSP		M – Male 	M08	8202 1215 44	1/4 BSP	
	M15	8202 1308 11	1/2 BSP			M10	8202 1215 45	3/8 BSP	
	M20	8202 1308 12	3/4 BSP			M15	8202 1215 46	1/2 BSP	
F – Female 	F10	8202 1308 13	3/8 BSP		F – Female 	F10	8202 1215 52	3/8 BSP	
	F15	8202 1308 14	1/2 BSP			F15	8202 1215 53	1/2 BSP	
	F20	8202 1308 15	3/4 BSP						

ARO standard

ErgoQIC 08AR

The ErgoQIC 08AR is a full flow quick coupling with no air restriction inside the coupling suitable for assembly tools and small drills. Upgrading any air system with ErgoQIC 08AR will give the benefit of productivity and energy efficiency.

- Full flow coupling.
- Ergonomic design, small size and low weight.
- Strong and durable.
- Safety feature according to EN 983 / ISO 4414.
- Main market: Global.



Nipple profile



Technical Data

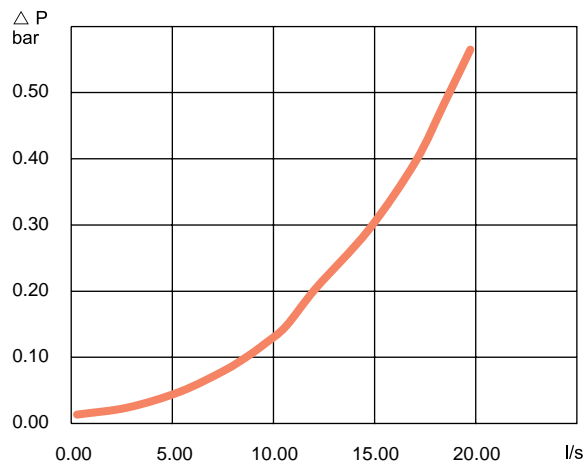

Max flow capacity 19 l/s (0.5 bar ΔP)
 Economical air flow 12 l/s (0.2 bar ΔP)
 Max working pressure 16 bar
 Temperature range -10°C to +70°C

Flow chart. ErgoQIC 08AR and NIP 08AR

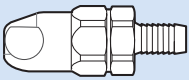

Air flow at an inlet pressure of 6.3 bar.

ErgoQIC 08AR and NIP 08AR, 12 l/s (recommended air flow at 6.3 bar pressure)

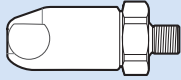
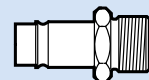
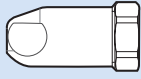
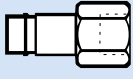
Connection type	Coupling ErgoQIC 08AR		Size		Connection type	Nipple NIP 08AR		Size	
		Ordering No.	mm	in			Ordering No.	mm	in
H – Hose 	H06	8202 1106 40	6.3	1/4	H – Hose 	H06	8202 1206 00	6.3	3/8
	H08	8202 1106 41	8	5/16		H08	8202 1206 01	8	1/2
	H10	8202 1106 42	10	3/8		H10	8202 1206 02	10	5/8
	H13	8202 1106 43	12.5	1/2		H13	8202 1206 03	12.5	3/4
M – Male 	M08	8202 1106 44	1/4	BSP	MT – Male taper thread 	MT08	8202 1206 04	1/4	BSPT
	M10	8202 1106 45	3/8	BSP		MT10	8202 1206 05	3/8	BSPT
	M15	8202 1106 46	1/2	BSP		MT15	8202 1206 06	1/2	BSPT
F – Female 	F08	8202 1106 47	1/4	BSP	F – Female 	F08	8202 1206 07	1/4	BSP
	F10	8202 1106 48	3/8	BSP		F10	8202 1206 08	3/8	BSP
						F15	8202 1206 09	1/2	BSP

Atlas Copco standard EU

ErgoQIC 10AC

The ErgoQIC 10AC is a full flow quick coupling with no air restriction inside the coupling suitable for assembly tools, drills and small grinders. Upgrading any air system with ErgoQIC 10AC will give the benefit of productivity and energy efficiency.

- Full flow coupling.
- Ergonomic design, small size and low weight.
- Strong and durable.
- Safety feature according to EN 983 / ISO 4414.
- Main market: Nordic, Benelux and Italy.



Nipple profile

Technical Data



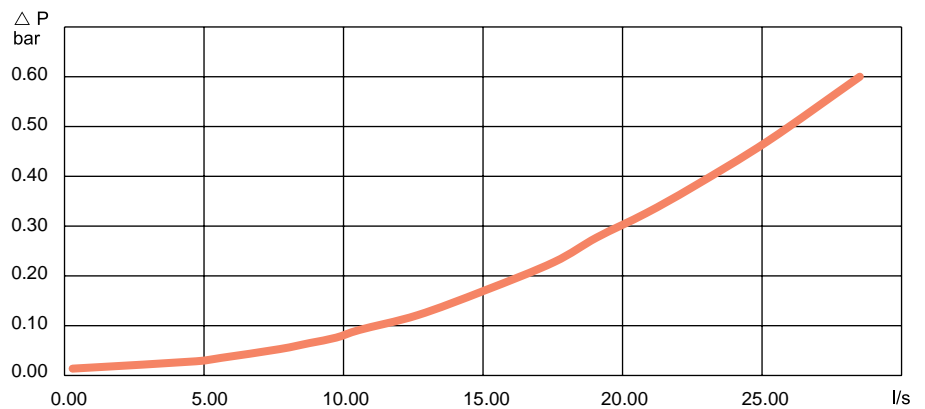

Max flow capacity 26 l/s (0.5 bar ΔP)
 Economical air flow 17 l/s (0.2 bar ΔP)
 Max working pressure 16 bar
 Temperature range -10°C to +70°C

Flow chart. ErgoQIC 10AC and NIP 10

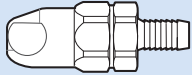

Air flow at an inlet pressure of 6.3 bar.

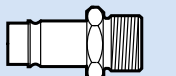
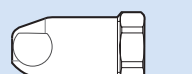
ErgoQIC 10AC and NIP 10, 17 l/s (recommended air flow at 6.3 bar pressure)

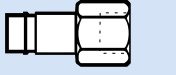
Connection type	Coupling ErgoQIC 10AC		Size		Connection type	Nipple NIP 10		Size	
		Ordering No.	mm	in			Ordering No.	mm	in
H – Hose 	H08	8202 1109 01	8	5/16	H – Hose 	H06	8202 1202 11	6.3	3/8
	H10	8202 1109 02	10	3/8		H08	8202 1202 94	8	1/2
	H13	8202 1109 03	12.5	1/2		H10	8202 1202 29	10	5/8
						H13	8202 1202 34	12.5	3/4
M – Male thread 	M08	8202 1109 05	1/4	BSP	M – Male thread 	M06	8202 1202 37	1/8	BSP
	M10	8202 1109 06	3/8	BSP		M08	8202 1202 45	1/4	BSP
	M15	8202 1109 07	1/2	BSP		M10	8202 1202 52	3/8	BSP
F – Female 	F08	8202 1109 09	1/4	BSP	MT – Male taper thread 	MT08	8202 1202 60	1/4	BSPT
	F10	8202 1109 10	3/8	BSP		MT10	8202 1202 78	3/8	BSPT
	F15	8202 1109 11	1/2	BSP		MT15	8202 1203 02	1/2	BSPT
					F – Female 	F08	8202 1202 86	1/4	BSP
						F10	8202 1202 87	3/8	BSP

Atlas Copco standard EU

QIC 10

The QIC 10 is a small quick coupling suitable for assembly tools and drills. The QIC 10 can withstand extremely rough handling in tough applications.

- High flow coupling.
- Strong and durable.
- One-hand operation.
- Main market: Europe and Australia.



Nipple profile



Technical Data

Max flow capacity 24 l/s (0.5 bar ΔP)
 Economical air flow 15 l/s (0.2 bar ΔP)
 Max working pressure 16 bar
 Temperature range -20°C to +80°C

Flow chart. QIC 10 M10 and NIP 10 M10

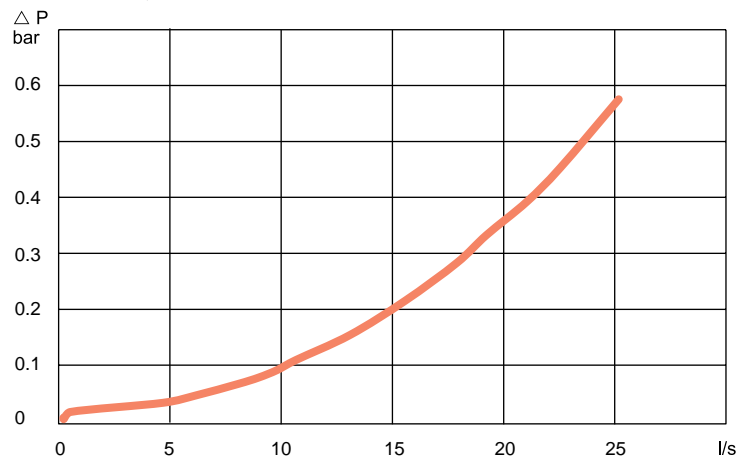

Air flow at an inlet pressure of 6.3 bar.

QIC 10 and NIP 10, 15 l/s (recommended air flow at 6.3 bar pressure)

Connection type	Coupling QIC 10	Ordering No.	Size		Connection type	Nipple NIP 10	Ordering No.	Size	
			mm	in				mm	in
H – Hose 	H06	8202 1302 02	6.3	1/4	H – Hose 	H06	8202 1202 11	6.3	1/4
	H08	8202 1302 10	8	5/16		H08	8202 1202 94	8	5/16
	H10	8202 1302 28	10	3/8		H10	8202 1202 29	10	3/8
	H13	8202 1302 34	12.5	1/2		H13	8202 1202 34	12.5	1/2
M – Male thread 	M08	8202 1302 36	1/4	BSP	SH – Safety Hose ^a 	SH06	8202 1203 10	6.3	1/4
	M10	8202 1302 44	3/8	BSP		SH08	8202 1203 36	8	5/16
						SH10	8202 1203 28	10	3/8
MT – Male taper thread 	MT15	8202 1302 51	1/2	BSPT	M – Male thread 	M06	8202 1202 37	1/8	BSP
						M08	8202 1202 45	1/4	BSP
						M10	8202 1202 52	3/8	BSP
F – Female 	F08	8202 1302 69	1/4	BSP	MT – Male taper thread 	MT08	8202 1202 60	1/4	BSPT
						MT10	8202 1202 78	3/8	BSPT
						MT15	8202 1203 02	1/2	BSPT
					F – Female 	F08	8202 1202 86	1/4	BSP
						F10	8202 1202 87	3/8	BSP

^a For hoses longer than 3 meters.

Atlas Copco standard EU

QIC 10S

QIC 10S safety coupling is suitable for assembly tools and drills. The QIC 10S is strong and durable and interchangeable with the QIC 10 coupling.

- High flow coupling.
- One-hand operation.
- Safety feature according to EN 983 / ISO 4414.
- Main market: Europe and Australia.





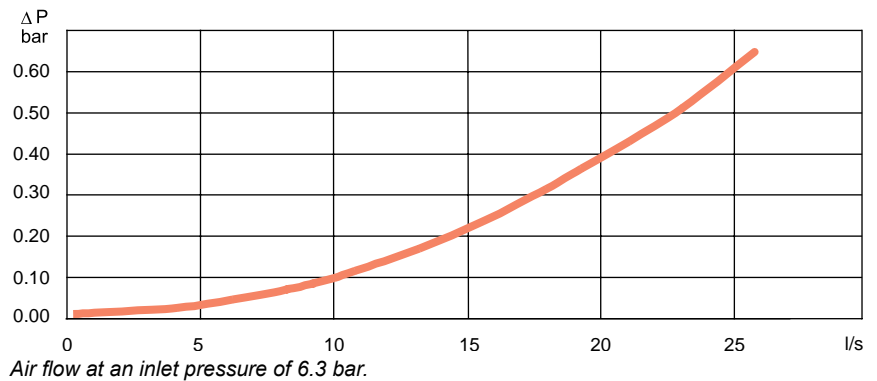

Technical Data

Max flow capacity 23 l/s (0.5 bar ΔP)
 Economical air flow 14 l/s (0.2 bar ΔP)
 Max working pressure 16 bar
 Temperature range -20°C to +80°C

Flow chart. QIC 10S M10 and NIP 10 M10

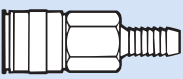

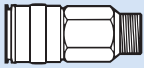
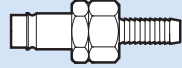
QIC 10S and NIP 10, 14 l/s (recommended air flow at 6.3 bar pressure)

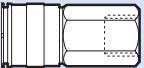
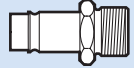
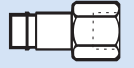
Connection type	Coupling QIC 10S	Ordering No.	Size		Connection type	Nipple NIP 10	Ordering No.	Size	
			mm	in				mm	in
H – Hose 	H06	8202 1302 08	6.3	1/4	H – Hose 	H06	8202 1202 11	6.3	1/4
	H08	8202 1302 18	8	5/16		H08	8202 1202 94	8	5/16
	H10	8202 1302 33	10	3/8		H10	8202 1202 29	10	3/8
	H13	8202 1302 39	12.5	1/2		H13	8202 1202 34	12.5	1/2
M – Male thread 	M08	8202 1302 43	1/4	BSP	SH – Safety hose^a 	SH06	8202 1203 10	6.3	1/4
	M10	8202 1302 54	3/8	BSP		SH08	8202 1203 36	8	5/16
	M15	8202 1302 81	1/2	BSP		SH10	8202 1203 28	10	3/8
MT – Male taper thread 	MT15	8202 1302 58	1/2	BSPT	M – Male thread 	M06	8202 1202 37	1/8	BSP
						M08	8202 1202 45	1/4	BSP
						M10	8202 1202 52	3/8	BSP
F – Female 	F08	8202 1302 73	1/4	BSP	MT – Male taper thread 	MT08	8202 1202 60	1/4	BSPT
	F10	8202 1302 74	3/8	BSP		MT10	8202 1202 78	3/8	BSPT
						MT15	8202 1203 02	1/2	BSPT
					F – Female 	F08	8202 1202 86	1/4	BSP
				F10		8202 1202 87	3/8	BSP	

^a For hoses longer than 3 meters.

Atlas Copco standard EU

QIC 15

The QIC 15 quick coupling is suitable for assembly tools, grinders and drills. The QIC 15 can withstand extremely rough handling in tough applications.

- Extremely high flow.
- Strong and durable.
- One-hand operation.
- Main market: Europe.



Nipple profile









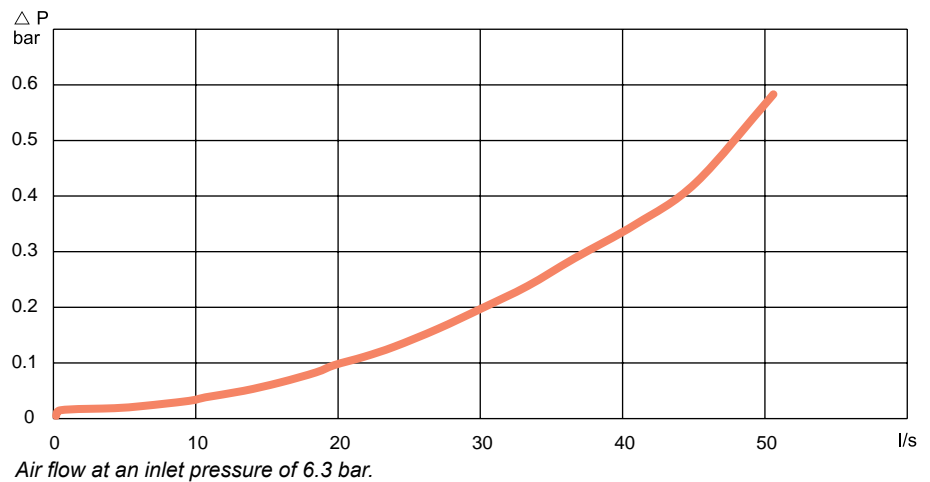

Technical Data

Max flow capacity 48 l/s (0.5 bar ΔP)
 Economical air flow 30 l/s (0.2 bar ΔP)
 Max working pressure 10 bar
 Temperature range -20°C to +80°C

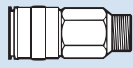
Flow chart. QIC 15 M15 and NIP 15 F15



QIC 15 and NIP 15, 30 l/s (recommended air flow at 6.3 bar pressure)

Connection type	Coupling QIC 15	Ordering No.	Size		Connection type	Nipple NIP 15	Ordering No.	Size	
			mm	in				mm	in
H – Hose 	H10	8202 1304 00	10	3/8	H – Hose 	H06	8202 1251 03	6.3	1/4
	H13	8202 1304 18	12.5	1/2		H08	8202 1252 28	8	5/16
	H16	8202 1304 26	16	5/8		H10	8202 1251 11	10	3/8
M – Male thread 	M08	8202 1304 34	1/4	BSP	SH – Safety Hose^a 	SH10	8202 1203 44	10	3/8
	M10	8202 1304 42	3/8	BSP		SH13	8202 1203 51	12.5	1/2
	M15	8202 1304 59	1/2	BSP		SH16	8202 1203 69	16	5/8
F – Female thread 	F15	8202 1304 67	1/2	BSP	M – Male thread 	M10	8202 1251 45	3/8	BSP
						M15	8202 1251 52	1/2	BSP
					MT – Male taper thread 	MT08	8202 1251 60	1/4	BSPT
						MT10	8202 1251 78	3/8	BSPT
						MT15	8202 1251 86	1/2	BSPT
					F – Female thread 	F08	8202 1251 94	1/4	BSP
						F10	8202 1252 02	3/8	BSP
						F15	8202 1252 10	1/2	BSP

^a For hoses longer than 3 meters.

Atlas Copco standard EU

QIC 15S

The QIC 15S safety coupling is suitable for assembly tools, grinders and drills. The QIC 15S is easy to handle, strong and durable.

- Exceptionally high flow.
- One-hand operation.
- Safety feature according to EN 983 / ISO 4414.
- Main market: Europe.



Nipple profile





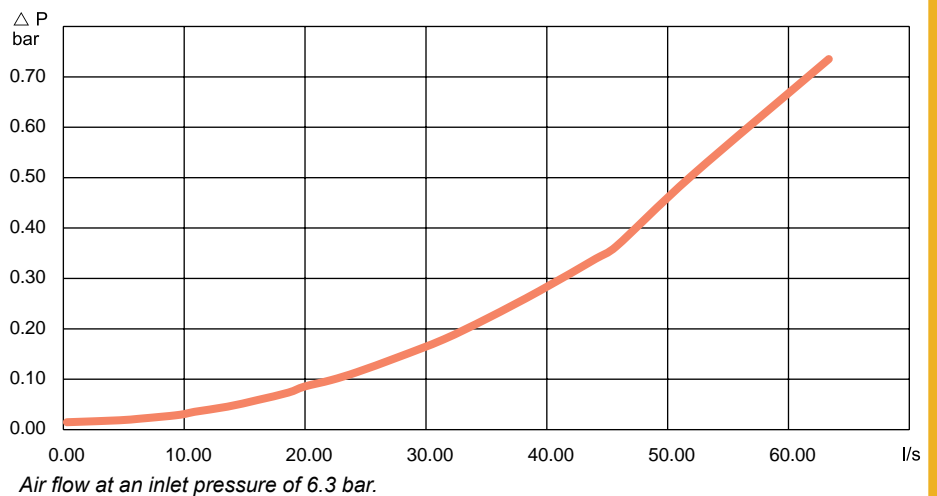

Technical Data

Max flow capacity 52 l/s (0.5 bar ΔP)
 Economical air flow 33 l/s (0.2 bar ΔP)
 Max working pressure 10 bar
 Temperature range -20°C to +80°C

Flow chart. QIC 15S M15 and NIP 15 F15

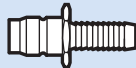
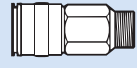
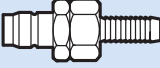
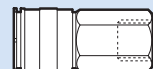

QIC 15S and NIP 15, 33 l/s (recommended air flow at 6.3 bar pressure)

Connection type	Coupling QIC 15S	Ordering No.	Size		Connection type	Nipple NIP 15	Ordering No.	Size	
			mm	in				mm	in
H – Hose 	H10	8202 1304 08	10	3/8	H – Hose 	H06	8202 1251 03	6.3	1/4
	H13	8202 1304 23	12.5	1/2		H08	8202 1252 28	8	5/16
	H16	8202 1304 33	16	5/8		H10	8202 1251 11	10	3/8
M – Male thread 	M08	8202 1304 38	1/4 BSP	SH – Safety Hose^a 	SH10	8202 1203 44	10	3/8	
	M10	8202 1304 48	3/8 BSP		SH13	8202 1203 51	12.5	1/2	
	M15	8202 1304 73	1/2 BSP		SH16	8202 1203 69	16	5/8	
F – Female thread 	F15	8202 1304 74	1/2 BSP	M – Male thread 	M10	8202 1251 45	3/8 BSP	MT – Male taper thread 	
					M15	8202 1251 52	1/2 BSP		
						MT08	8202 1251 60	1/4 BSPT	
						MT10	8202 1251 78	3/8 BSPT	
						MT15	8202 1251 86	1/2 BSPT	
						F – Female thread 	F08	8202 1251 94	1/4 BSP
					F10		8202 1252 02	3/8 BSP	
					F15		8202 1252 10	1/2 BSP	

^a For hoses longer than 3 meters.

ASIA standard

ErgoQIC 10 ASIA

The ErgoQIC 10 ASIA is a full flow coupling with no air restriction inside the coupling. It is suitable for assembly tools, drills and grinders. Upgrading any air system with ErgoQIC 10 ASIA will give the benefits of productivity and energy efficiency.

- Extreme full flow coupling.
- Strong and durable.
- Minimized connection force.
- Safety feature according to EN 983 / ISO 4414.
- Main market: Asia, Italy.





Technical Data

Max flow capacity 35 l/s (0.5 bar ΔP)
 Economical air flow 22 l/s (0.2 bar ΔP)
 Max working pressure 16 bar
 Temperature range -10°C to +70°C

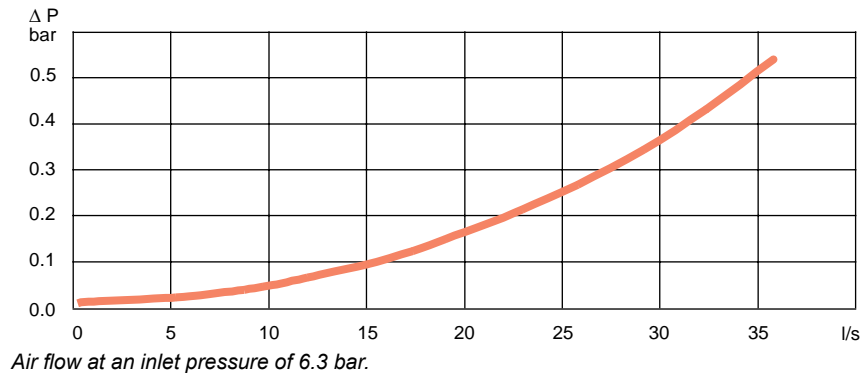
Flow chart. ErgoQIC 10 ASIA and NIP 10 ASIA

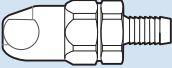

ErgoQIC 10 ASIA and NIP 10 ASIA, 22 l/s (recommended air flow at 6.3 bar pressure)

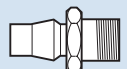
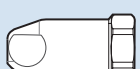
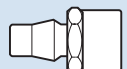
Connection type	Coupling ErgoQIC 10 ASIA	Ordering No.	Size		Connection type	Nipple NIP 10 ASIA	Ordering No.	Size	
			mm	in				mm	in
H – Hose 	H06	8202 1104 00	6.3	1/4	H – Hose 	H06	8202 1202 15	6.3	1/4
	H08	8202 1104 01	8	5/16		H08	8202 1202 16	8	5/16
	H10	8202 1104 02	10	3/8		H10	8202 1202 17	10	3/8
	H13	8202 1104 03	12.5	1/2		H13	8202 1202 18	12.5	1/2
MT – Male taper thread 	MT08	8202 1104 05	1/4 BSPT		MT – Male taper thread 	MT06	8202 1202 19	1/8 BSPT	
	MT10	8202 1104 06	3/8 BSPT			MT08	8202 1202 20	1/4 BSPT	
	MT15	8202 1104 07	1/2 BSPT			MT10	8202 1202 21	3/8 BSPT	
						MT15	8202 1202 22	1/2 BSPT	
FT – Female taper thread 	FT08	8202 1104 09	1/4 BSPT		FT – Female taper thread 	FT08	8202 1202 23	1/4 BSPT	
	FT10	8202 1104 10	3/8 BSPT			FT10	8202 1202 24	3/8 BSPT	
	FT15	8202 1104 11	1/2 BSPT			FT15	8202 1202 25	1/2 BSPT	

ASIA standard

QIC 10 ASIA

The QIC 10 ASIA quick coupling is suitable for assembly tools, drills and small grinders. The QIC 10 ASIA has a wide range of connections available and it is interchangeable with asia standard nipples.

- High flow.
- One-hand operation.
- Strong and durable.
- Main market: Asia.



Technical Data

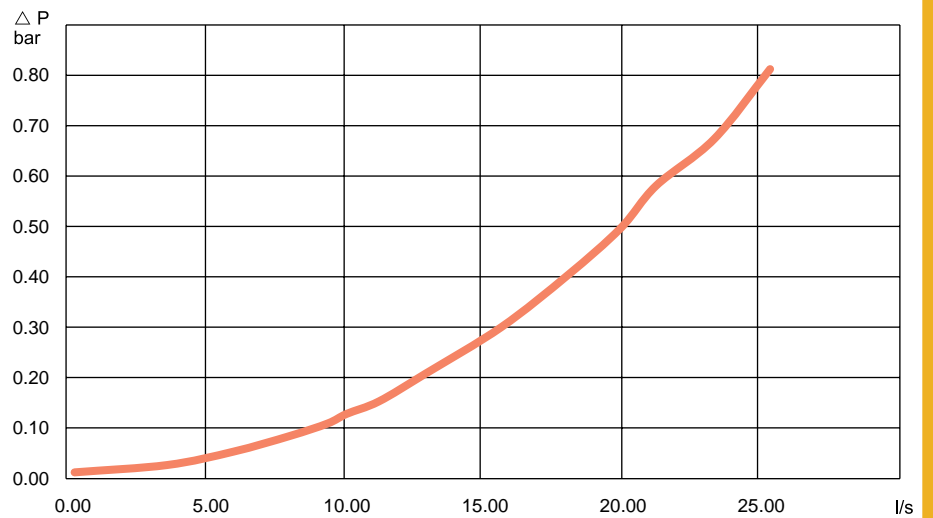

Max flow capacity 20 l/s (0.5 bar ΔP)
 Economical air flow 13 l/s (0.2 bar ΔP)
 Max working pressure 10 bar
 Temperature range -20°C to +80°C

Flow chart. QIC 10 ASIA and NIP 10 ASIA

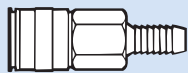

Air flow at an inlet pressure of 6.3 bar.

QIC 10 ASIA and NIP 10 ASIA, 13 l/s (recommended air flow at 6.3 bar pressure)

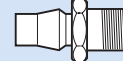
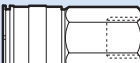
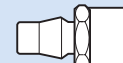
Connection type	Coupling QIC 10 ASIA	Ordering No.	Size		Connection type	Nipple NIP 10 ASIA	Ordering No.	Size	
			mm	in				mm	in
 H – Hose	H06	8202 1302 85	6.3	1/4	 H – Hose	H06	8202 1202 15	6.3	1/4
	H08	8202 1302 86	8	5/16		H08	8202 1202 16	8	5/16
	H10	8202 1302 87	10	3/8		H10	8202 1202 17	10	3/8
	H13	8202 1302 88	12.5	1/2		H13	8202 1202 18	12.5	1/2
 MT – Male taper thread	MT08	8202 1302 89	1/4	BSPT	 MT – Male taper thread	MT06	8202 1202 19	1/8	BSPT
	MT10	8202 1302 90	3/8	BSPT		MT08	8202 1202 20	1/4	BSPT
	MT15	8202 1302 91	1/2	BSPT		MT10	8202 1202 21	3/8	BSPT
 FT – Female taper thread	FT08	8202 1302 92	1/4	BSPT	 FT – Female taper thread	FT08	8202 1202 23	1/4	BSPT
	FT10	8202 1302 93	3/8	BSPT		FT10	8202 1202 24	3/8	BSPT
	FT15	8202 1302 94	1/2	BSPT		FT15	8202 1202 25	1/2	BSPT

CLAW couplings are made from drop-forged, hardened steel which can withstand rough treatment and ensures a long life even under difficult conditions. The coupling head is the same for all sizes, which can therefore be freely combined.

The recommended maximum working pressure is 10 bar.

- Large bore – machined surfaces give low air resistance and minimum pressure drop.
- Robust claws – will withstand rough handling without deformation.
- Locking lugs – precision-made to provide a reliable lock.
- Special rubber packings – resistant to oil and temperature changes. Max. temperature 80°C (176°F).
- Packing seats – lathe-turned grooves ensure a leak-proof seal.
- Couplings are zinc-plated and thus effectively treated against corrosion.



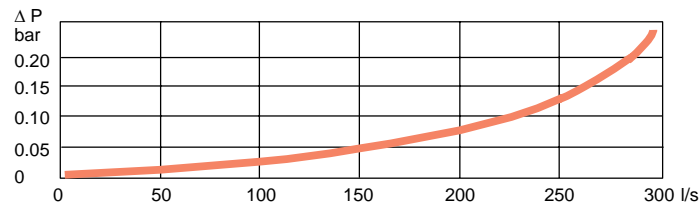

Flow chart. For 2 pieces of CLAW

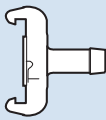
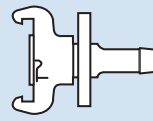
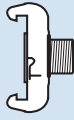
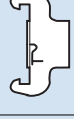

Air flow at an inlet pressure of 6 bar.

CLAW

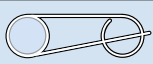
Connection type	Coupling CLAW	Ordering No.	Size		Bore B, mm
			mm	in	
H – Hose 	H06	9000 0308 00	6.3	1/4	5.0
	H10	9000 0309 00	10	3/8	8.0
	H13	9000 0310 00	12.5	1/2	10.5
	H16	9000 0311 00	16	5/8	13.5
	H20	9000 0312 00	19	3/4	17.0
	H25	9000 0313 00	25	1	22.0
LNH – Lock nut, Hose 	LNH10	9000 0260 00	10	3/8	8.0
	LNH13	9000 0261 00	12.5	1/2	10.5
	LNH16	9000 0262 00	16	5/8	13.5
	LNH20	9000 0263 00	19	3/4	17.2
	LNH25	9000 0264 00	25	1	22.0
M – Male thread 	M10	9000 0300 00		3/8 BSP	11.2
	M15	9000 0301 00		1/2 BSP	14.8
	M20	9000 0302 00		3/4 BSP	19.0
	M25	9000 0303 00		1 BSP	25.5
F – Female thread 	F10	9000 0304 00		3/8 BSP	15.0
	F15	9000 0305 00		1/2 BSP	18.6
	F20	9000 0306 00		3/4 BSP	24.0
	F25	9000 0307 00		1 BSP	25.0
Protection cover for CLAW couplings		9000 0314 00			
Extra packing for CLAW couplings		For type H, M and F	9000 0000 00 (+80°C), 9000 0000 01 (+200°C) ^a		
		For LNH10, -13 and -16	9000 0015 00		
		For LNH20 and -25	9000 0268 00 (+80°C), 9000 0319 00 (+200°C) ^a		
Safety lock spring		3176 8640 90	25 pieces		

^a Viton-green.

BAL and BAL-1A

The Atlas Copco valves BAL and BAL-1A are both suitable for air, water and many other liquids and gases due to the choice of material.

- Silicone-free grease – Both are lubricated with silicone-free grease which is important when spray-painting.
- Maximum through flow – Full bore valve to DIN standards.
- Housing and ball made of chrome-plated hot-stamped brass MS 58.
- Handle of enamelled aluminum.



BAL – with nitrile rubber seals

BAL valves can be used in all settings between fully open and fully closed.

The balls and the seals can be replaced without the body being removed from the piping.

BAL-1A – with teflon seals

Intended for operating either fully open or fully closed.

Technical data

BAL

Maximum working pressure: 16 bar.

Working temperature range: -20°C to +90°C.

BAL-1A

Maximum working pressure: 16 bar (BAL-1A 40 and 50: max. 16 bar up to +100°C).

Working temperature range: -30°C to +200°C. (BAL-1A 40 and 50: at +200°C max. working pressure is reduced to 8 bar).

Model	Connection thread in BSP	Bore D mm	L mm	H mm	I mm	Ordering No.
BAL 08	1/4	9.5	50	41	-	8202 0301 05
BAL 10	3/8	9.5	50	41	-	8202 0302 04
BAL 15	1/2	12.5	60	43	-	8202 0303 03
BAL 20	3/4	19	75	55	-	8202 0304 02
BAL 25	1	24.5	90	64	-	8202 0305 01
BAL-1A 08	1/4	8	43	44	73	8202 0306 03
BAL-1A 10	3/8	10	50	47	73	8202 0306 11
BAL-1A 15	1/2	15	61	53	94	8202 0306 29
BAL-1A 20	3/4	20	70	57	94	8202 0306 37
BAL-1A 25	1	25	83	67.5	122	8202 0306 45
BAL-1A 32	1 1/4	32	100	83	150	8202 0306 52
BAL-1A 40	1 1/2	38	107	87	150	8202 0306 60
BAL-1A 50	2	50	129	103	193	8202 0306 78

Dimensions

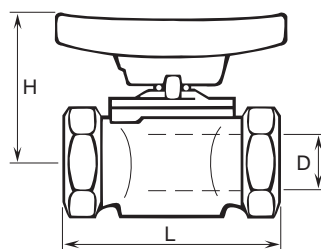

Double connection

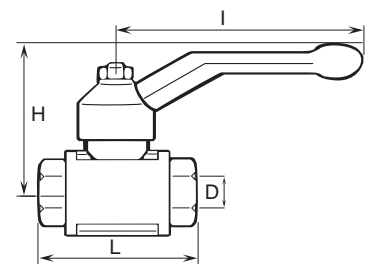

BAL

MultiFlex Swivel Multi-directional connector

The MultiFlex swivel is an ingenious multi-directional connector. Connect your tool and the hose will stay in the ideal position however much you and the tool move around. The MultiFlex bends and rotates 360° in all directions while the hose stays straight. It takes the effort out of working in those cramped spaces. What's more, the hose feels almost weightless and it reduces hose wear. It's the magic of MultiFlex – a marriage of ergonomic thinking and ingenious design.

- Ergonomic.
- Reduces hose wear.
- High flow capacity.
- Minimum pressure drop.
- Strong and durable.
- Cover made of EPDM.



Model	Max rec. air flow ^a		Thread		Weight g	Length mm	Dia mm	Ordering No.
	l/s	cfm	Inlet female in	Outlet male in				
MultiFlex 1/8" BSP	12	25	1/8	1/8	73	66.2	24	8202 1350 18
MultiFlex 1/4" BSP	12	25	1/4	1/4	73	66.2	24	8202 1350 20
MultiFlex 3/8" BSP	32	68	3/8	3/8	130	80.6	29.5	8202 1350 22
MultiFlex 1/2" BSP	32	68	1/2	1/2	125	80.6	29.5	8202 1350 24
MultiFlex 1/8" BSP ^b	12	25	1/8	1/8	76	66.2	27	8202 1350 40
MultiFlex 1/4" BSP ^b	12	25	1/4	1/4	76	66.2	27	8202 1350 41
MultiFlex 1/2" BSP ^c	54	114	1/2	1/2	326	98.3	39	8202 1350 60

^a The pressure drop will be 0.2 bar at an inlet pressure of 6 bar.

^b With cover.
^c HIGH FLOW.

Flow chart

MultiFlex 1/2" or 3/8"

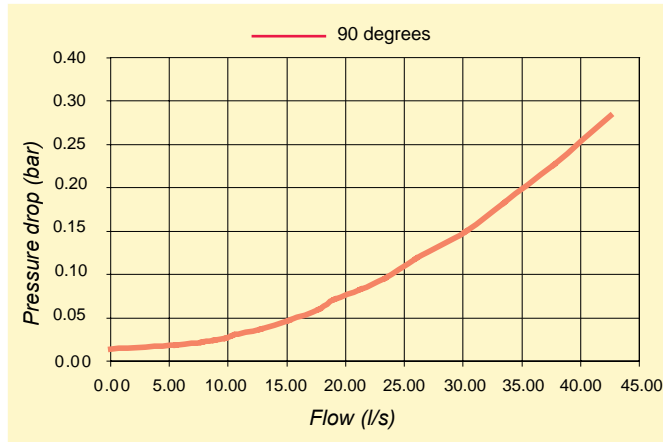

MultiFlex 1/8" or 1/4"

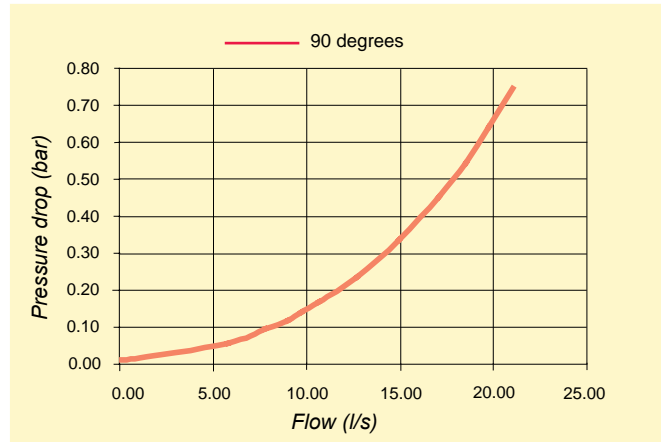

MultiFlex HIGH FLOW

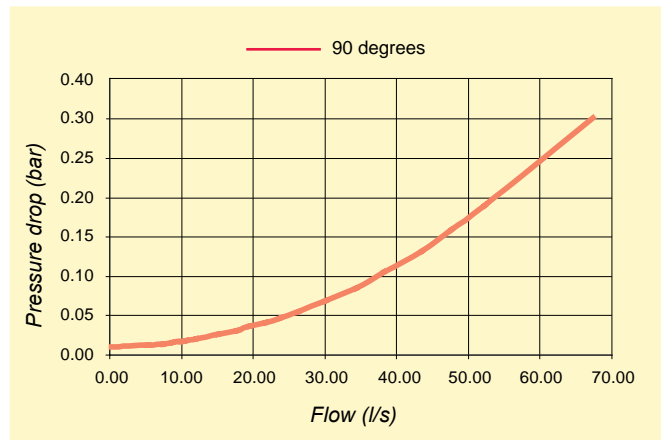



Simple pressure clamps for PVC HOSES

For CABLAIR	For PVC	One-lugged steel clamp mm	Ordering No.
-	-	5.2- 6.2	0347 0122 18
-	-	5.9- 7.0	0347 0122 19
-	03	7.0- 8.5	0347 0122 05
06	05	8.5-10.0	0347 0122 06
08	06	9.8-11.8	0347 0122 07
-	08	11.3-13.3	0347 0122 08
10	-	12.8-14.8	0347 0122 09
-	10	14.6-16.8	0347 0122 10
13	-	16.5-18.8	0347 0122 11
-	13	18.0-20.3	0347 0122 12
16	-	20.2-22.8	0347 0122 13
-	-	22.0-24.8	0347 0122 14
20	-	23.3-26.3	0347 0122 15
-	-	26.5-30.0	0347 0122 16
25	-	29.8-33.1	0347 0122 22



Hose connection Male thread – hose nipple

Thread in	Hose size		Ordering No.
	mm	in	
1/8 BSP	3.2	1/8	9000 0523 00
1/8 BSPT	5	3/16	4010 0031 00
1/8 BSPT	6.3	1/4	9000 0240 00
1/4 BSP	3.2	1/8	9000 0524 00
1/4 BSPT	6.3	1/4	9000 0241 00
1/4 BSPT	8	5/16	9090 1715 00
1/4 BSPT	10	3/8	9000 0247 00
3/8 BSPT	10	3/8	9000 0248 00
3/8 BSPT	12.5	1/2	9000 0248 00
1/2 BSPT	12.5	1/2	9000 0243 00
1/2 BSPT	16	5/8	9000 0244 00
1/2 BSP	20	3/4	4150 0429 00
3/4 BSPT	20	3/4	9000 0245 00
1 BSPT	25	1	9000 0246 00



Medium pressure clamps for PVC HOSES

For CABLAIR	For PVC, POLUR	Medium clamp worm drive mm	Ordering No.
-	-	8.0-14.0	0347 6102 00
-	08	11.0-17.0	0347 6103 00
-	10	11.0-17.0	0347 6103 00
-	-	13.0-20.0	0347 6104 00
16	13	15.0-24.0	0347 6105 00
20	16	19.0-28.0	0347 6106 00
-	20	22.0-32.0	0347 6107 00
25	25	26.0-38.0	0347 6109 00
-	-	32.0-44.0	0347 6111 00
-	-	38.0-50.0	0347 6112 00
-	-	50.0-65.0	0347 6113 00



Gaskets

For couplings with male parallel thread	Fiber gasket between material and nipple Ordering No.
M5	0657 5710 00
1/8 BSP	0657 5742 00
1/4 BSP	0657 5764 00
3/8 BSP	0657 5785 00
1/2 BSP	0653 0500 01
3/4 BSP	0657 5823 00
1 BSP	0657 5830 00



Medium pressure clamps for RUBBER HOSES

For TURBO	For RUBAIR	Medium clamp worm drive mm	Ordering No.
-	06	11.0-17.0	0347 6103 00
13	10	13.0-20.0	0347 6104 00
16	13	15.0-24.0	0347 6105 00
-	16	19.0-28.0	0347 6106 00
20	-	22.0-32.0	0347 6107 00
-	20	26.0-38.0	0347 6109 00



Reducing nipple in brass

Female thread in	Male thread in	Ordering No.
1/4 BSP	1/8 BSP	9721 4000 94
3/8 BSP	1/4 BSP	9721 4000 92
1/2 BSP	3/8 BSP	9721 4000 93



Heavy-duty pressure clamps for RUBBER HOSES

For TURBO	For RUBAIR	Heavy-duty clamp mm	Ordering No.
-	-	22.0-25.0	9000 0194 00
20	16	25.0-28.0	9000 0195 00
-	20	29.0-32.0	9000 0196 00
-	25	34.0-38.0	9000 0197 00



Swivels

Air inlet	Air outlet Male BSP	Max Swivel bend from centre line	Ordering No.
5/16" hose	1/4	30°	4210 3134 80

Recommended flow max 10 l/s

Fittings

Bushing

Male thread – female thread



Male thread in	Female thread in	Ordering No.
1/4 BSP	1/8 BSP	9090 0799 00
3/8 BSP	1/4 BSP	9090 0798 00
1/2 BSP	1/4 BSP	9090 1469 00
1/2 BSP	3/8 BSP	9090 0797 00
3/4 BSP	1/2 BSP	9090 0796 00
1 BSPT	3/4 BSP	9090 0795 00

Double connection

Male taper thread – male taper thread



From thread in	To thread in	Ordering No.
1/8 BSPT	1/8 BSPT	9090 0100 00
1/8 BSPT	1/4 BSPT	9090 0110 00
1/4 BSPT	1/4 BSPT	9090 0120 00
1/4 BSPT	3/8 BSPT	9090 0130 00
3/8 BSPT	3/8 BSPT	9090 0140 00
3/8 BSPT	1/2 BSPT	9090 0150 00
1/2 BSPT	1/2 BSPT	9090 0160 00
1/2 BSPT	3/4 BSPT	9090 0170 00
3/4 BSPT	3/4 BSPT	9090 0180 00
3/4 BSPT	1 BSPT	9090 0190 00
1 BSPT	1 BSPT	9090 0200 00

Double adjustable connection

Male thread – male thread



From thread in	To thread in	Ordering No.
1/2 BSP	1/2 BSP	9090 0806 00

Sealing rings for double adjustable connection



For coupling with male thread in	Spare rubber sealing ring for adjustable connections Ordering No.
1/2 BSP	9090 0884 00
1 BSP	9090 0886 00

Hose connection with clamp nut and spring guard

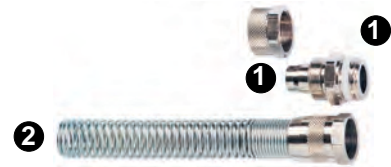

1 Clamp nut, brass

Hose diameter Outside/Inside mm	Male thread in	Ordering No.
10/8 ^a	1/4 BSP	9721 4002 89
10/8 ^a	3/8 BSP	9721 4002 90
12/9	1/4 BSP	9721 4000 86
12/10 ^b	3/8 BSP	9721 4000 88
15/12.5 ^c	1/2 BSP	9721 4000 89

Male threaded hose nipple with clamp nut should be used with female threaded quick couplings.

2 Spring guard in steel

Hose diameter Outside/Inside mm	Ordering No.
10/8 ^a	9721 4002 88
12/10 ^b	9721 4000 91
15/12 ^c	9721 4002 85

The spring guard should be used with the clamp nut above.

^aCABLAIR 08

^bCABLAIR 10

^cCABLAIR 13

Manifolds

3/8 inlet on each side, 1/4 outlets for couplings



Inlet in	Thread		Number of outlets	Ordering No.
	Inlet in	Outlet in		
3/8 BSP	1/4 BSP	1/4 BSP	4	9090 0201 00
3/8 BSP	1/4 BSP	1/4 BSP	5	9090 0201 01
3/8 BSP	1/4 BSP	1/4 BSP	6	9090 0201 02

Manifolds

3/8 inlet on each side, 1/4 outlet on both sides for couplings



Inlet in	Thread		Number of outlets	Ordering No.
	Inlet in	Outlet in		
3/8 BSP	1/4 BSP	1/4 BSP	4	9090 0201 10
3/8 BSP	1/4 BSP	1/4 BSP	6	9090 0201 11
3/8 BSP	1/4 BSP	1/4 BSP	8	9090 0201 12
3/8 BSP	1/4 BSP	1/4 BSP	10	9090 0201 13



Y-connections
2 female outlets and 1 male inlet

Model	Female thread in	Male thread in	Ordering No.
F/F/M08	1/4 BSP	1/4 BSP	9090 0201 86
F/F/M10	3/8 BSP	3/8 BSP	9090 0201 87
F/F/M15	1/2 BSP	1/2 BSP	9090 0201 85



Pipe tee

Model	Female threads in	Ordering No.
F08	1/4 BSP	9090 0201 51
F10	3/8 BSP	9090 0201 53
F15	1/2 BSP	9090 0201 50
F20	3/4 BSP	9090 0201 52
F25	1 BSP	9090 0201 54



Pipe cross

Model	Female thread in	Ordering No.
F08	1/4 BSP	9090 0201 21
F10	3/8 BSP	9090 0201 22
F15	1/2 BSP	9090 0201 20



Branch tee
2 female outlets and 1 male inlet

Model	Female thread in	Male thread in	Ordering No.
2xF08 1xM08	1/4 BSP	1/4 BSP	9090 0201 61
2xF10 1xM10	3/8 BSP	3/8 BSP	9090 0201 63
2xF15 1xM15	1/2 BSP	1/2 BSP	9090 0201 60
2xF20 1xM20	3/4 BSP	3/4 BSP	9090 0201 62
2xF25 1xM25	1 BSP	1 BSP	9090 0201 64



Cross
3 female threads and 1 male thread

Model	Female thread in	Male thread in	Ordering No.
3xF08 1xM08	1/4 BSP	1/4 BSP	9090 0201 31
3xF10 1xM10	3/8 BSP	3/8 BSP	9090 0201 32
3xF15 1xM15	1/2 BSP	1/2 BSP	9090 0201 30



Run tee
2 female outlets and 1 male inlet

Model	Female thread in	Male thread in	Ordering No.
F08/M08/F08	1/4 BSP	1/4 BSP	9090 0201 71
F10/M10/F10	3/8 BSP	3/8 BSP	9090 0201 72
F15/M15/F15	1/2 BSP	1/2 BSP	9090 0201 70



Pipe elbow

Model	Female thread in	Ordering No.
F08	1/4 BSP	9090 0201 40
F10	3/8 BSP	9090 0201 43
F15	1/2 BSP	9090 0201 41
F20	3/4 BSP	9090 0201 42
F25	1 BSP	9090 0201 44



Hex head plug

Model	Male thread in	Ordering No.
M08	1/4 BSP	9090 0201 81
M10	3/8 BSP	9090 0201 84
M15	1/2 BSP	9090 0201 80
M20	3/4 BSP	9090 0201 83
M25	1 BSP	9090 0201 82

When a fitting comes loose from a pressurized hose, the hose starts blowing compressed air in an uncontrolled way. The blow protector shuts off the airflow, thus minimizing the risk of injuries to personnel and damage to the workpiece or the surroundings.

The selection parameters are the air pressure and the air flow. For proper function the air pressure should be set at 7 bar in order to reach 6 bar at the air tool. The air flow is determined by the air consumption of the tool and the hose length.

When working with impact wrenches and pulse tools care must be taken in the choice of blow protector. The value of air flow under full load must be increased by 50% when selecting a blow protector for impact wrenches and pulse tools as there will otherwise be a risk of shut-off when free running.

BLOCK has automatic reset. When the air is switched on again the valve in BLOCK opens and is automatically reset.

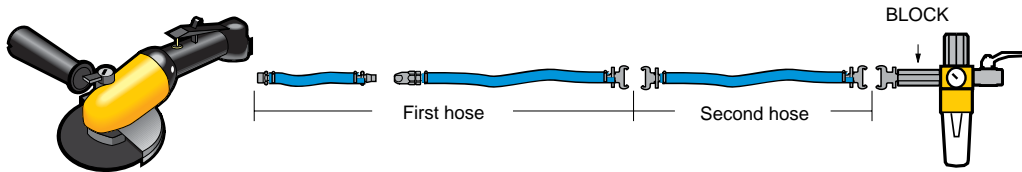
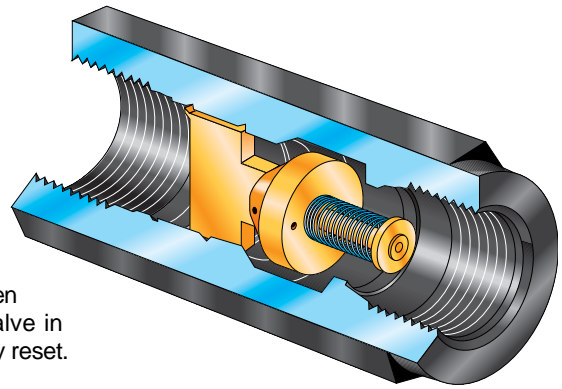

Selection table using standard hoses

The air flow, hose length and hose sizes must all be within the recommended range in order to choose the correct blow protector. The second hose is only used when hoses longer than 20 m are used. The second hose will always be 20 m and the first hose will be cut to the right length.

Max working pressure = 16 bar.

Air flow air tool l/s	First hose		Second hose		Shut off air flow l/s	Product	Female thread BSP	Ordering No.
	length m	size mm	length m	size mm				
0- 5	1- 5	6.3	0	–	7.8	BLOCK 08L	1/4	8202 0100 50
0- 5	6-10	8	0	–	13	BLOCK 08H	1/4	8202 0100 52
0- 8	1- 5	8	0	–	13	BLOCK 08H	1/4	8202 0100 52
0- 8	6-10	10	0	–	13	BLOCK 08H	1/4	8202 0100 52
0-10	1-10	10	0	–	13	BLOCK 08H	1/4	8202 0100 52
0-10	11-20	12.5	0	–	13	BLOCK 08H	1/4	8202 0100 52
0-14	1- 5	10	0	–	18	BLOCK 10L	3/8	8202 0100 54
0-14	6-10	13	0	–	18	BLOCK 10L	3/8	8202 0100 54
0-15	11-20	16	0	–	32	BLOCK 10H	3/8	8202 0100 56
0-25	1- 5	12.5	0	–	32	BLOCK 10H	3/8	8202 0100 56
0-25	6-10	16	0	–	32	BLOCK 10H	3/8	8202 0100 56
0-35	1- 5	12.5	0	–	45	BLOCK 15H	1/2	8202 0100 58
0-35	6-10	16	0	–	45	BLOCK 15H	1/2	8202 0100 58
0-35	11-20	19	0	–	45	BLOCK 15H	1/2	8202 0100 58
0-60	1-10	19	0	–	75	BLOCK 20H	3/4	8202 0100 60
0-60	1-10	19	20	25	75	BLOCK 20H	3/4	8202 0100 60
0-70	1- 7	19	0	25	86	BLOCK 25H	1	8202 0100 62
0-70	8-20	25	0	25	86	BLOCK 25H	1	8202 0100 62
0-70	1-20	25	20	25	86	BLOCK 25H	1	8202 0100 62

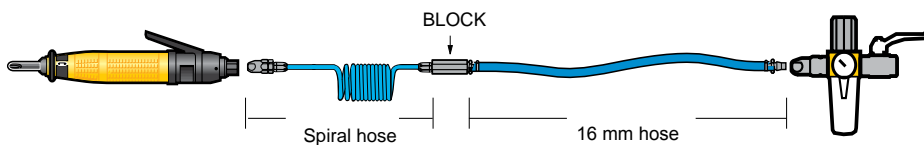

Selection table when using spiral hoses and hose balancers

The airflow, spiral hose and hose balancer must all be within recommended range in order to choose the correct BLOCK blow protector.

The second hose, only used when needed, is a 16 mm normal hose with a maximum length of 5 meter. The second hose should be placed between the BLOCK and the FRI unit.

Air flow air tool l/s	Spiral hose or balancer				Shut off air flow l/s	Product	Female thread BSP	Ordering No.
	Model	Hose length m	Hose size mm					
0- 4	SPI 06-3	2.5	6		8.3	BLOCK 08L	1/4	8202 0100 50
0- 6	HRIL 3	1.4	–		8.3	BLOCK 08L	1/4	8202 0100 50
0- 6	SPI 1S	2.0	6		8.3	BLOCK 08L	1/4	8202 0100 50
0- 6	SPI 2L	6.0	8		8.3	BLOCK 08L	1/4	8202 0100 50
0- 8	HRIL 4	1.1	–		14	BLOCK 08H	1/4	8202 0100 52
0- 8	SPI 09-3	2.5	9		14	BLOCK 08H	1/4	8202 0100 52
0- 8	SPI 2M	4.0	8		14	BLOCK 08H	1/4	8202 0100 52
0-11	SPI 2S	3.0	8		14	BLOCK 08H	1/4	8202 0100 52
0-11	SPI 2L	6.0	11		14	BLOCK 08H	1/4	8202 0100 52
0-15	SPI 3M	4.0	11		19	BLOCK 10L	3/8	8202 0100 54
0-20	SPI 3S	3.0	11		32	BLOCK 10H	3/8	8202 0100 56

Pressure drop diagram for straight hoses

This diagram helps you to choose the right hose according to the air consumption of the tool and the length of the hose. The purpose of the diagram is to ensure that the pressure drop in the hoses does not exceed 0.2 bar.

How to read the diagram:

Look up the tools required air consumption at 6 bar.

Use this value in the diagram .

What length of hose do you need?

Look at the diagram to see which hose size you need.

Decide which type of hose you need, Atlas Copco Tools has seven different hoses covering all types of needs for pneumatic hand tools.

Example

The tool has an air consumption of 10 l/s and the application requires a hose length of 7 m. These two values have a cross point slightly under the 10 mm size hose (7 m of 10 mm hose gives a value of approximately 11 l/s).

Therefore a 10 mm hose will be suitable.

Pressure drop diagram for hoses

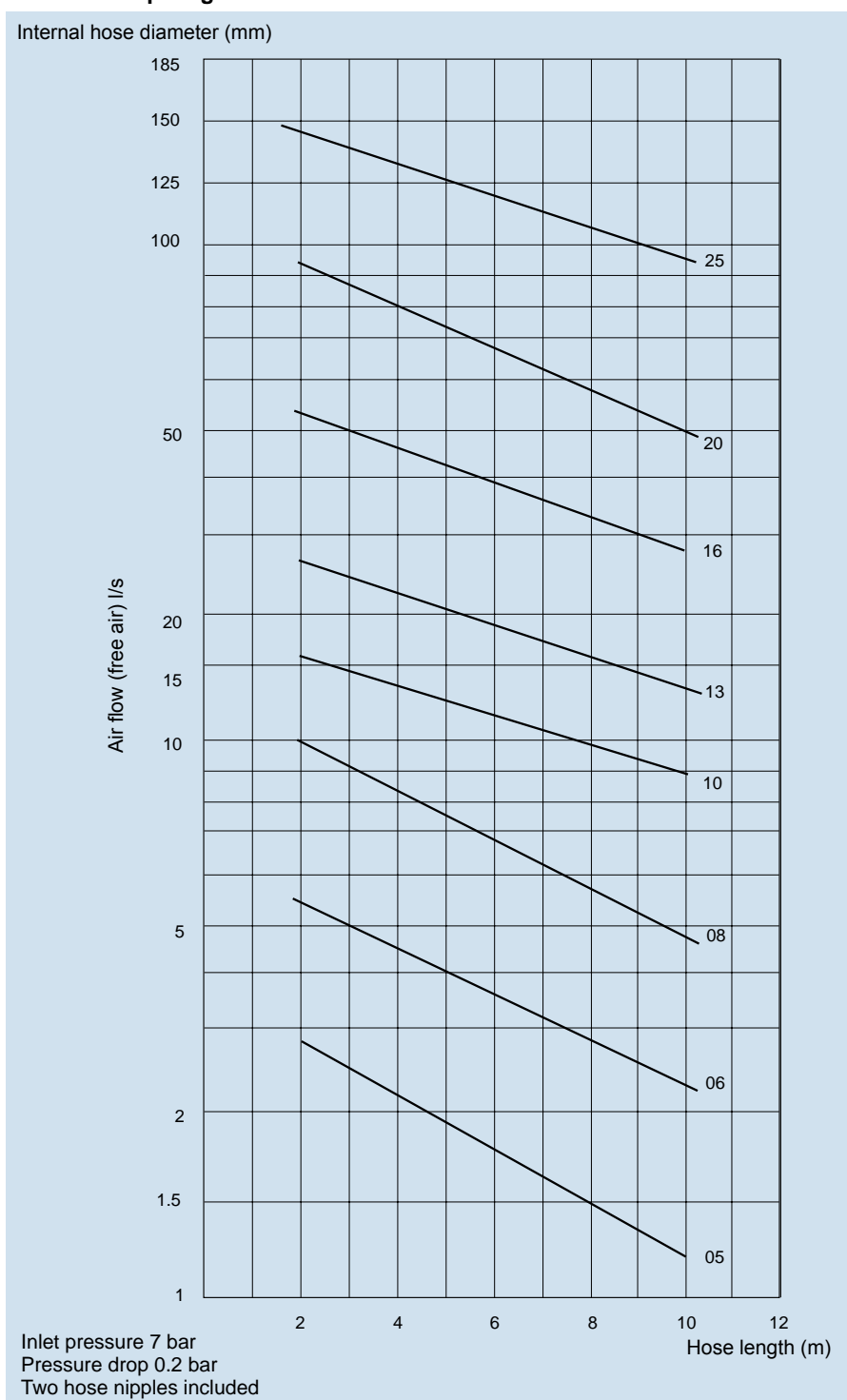

CABLAIR hoses

Super-light flexible PVC-hose

Cablaire is made of high-strength, high performance PVC compound. The Cablaire hose weighs 30-50% less and is much softer and more flexible than conventional PVC hoses. This ensures complete freedom of movement for operators of pneumatic hand tools in any working environment.

- Low weight.
- Extremely soft and flexible.
- Silicone free.
- Ergonomic.
- Working temperature -15°C to +60°C.
- Applicable standards BS EN ISO 6224:2011, BS EN ISO 5774:2008.



Model	Hose inside dia		Hose outside dia		Max working pressure ^a bar	Max rec. air flow ^b l/s	Weight per 30 m coil kg	Ordering No.
	mm	in	mm	in				
CABLAIR 06	6	1/4	8.5		14	4	1.2	9093 0035 11
CABLAIR 08	8	1/3	11		14	7.5	1.7	9093 0035 41
CABLAIR 10	10	2/5	13		12	13	2.1	9093 0035 71
CABLAIR 13	12.5	1/2	16		11	21	3.0	9093 0036 01
CABLAIR 16	16	5/8	21		8	43	5.4	9093 0036 31
CABLAIR 20	19	3/4	24		8	75	5.8	9093 0036 61
CABLAIR 25	25	1	31.5		7	125	10.4	9093 0036 91

^a With a safety factor of 3 at 20°C (at the max temp of +60°C the working pressure should be reduced by 50%).

^b The pressure drop will be 0.2 bar on a hose length of 5 m.

CABLAIR ESD

Extra flexible antistatic air hose

Cablaire ESD is designed specifically for use within the computer manufacturing industry. The hose possesses properties which enable ESDS (electrostatic sensitive devices) to be handled in a protected area with a low risk level, as a result of electrostatic discharge. In addition to a known demand in the computer industry, it is expected that potential exists in the electronics, radio and communication fields. The connection device must be earthed/grounded.

- Extra flexible.
- Antistatic.
- Silicone free.
- Testing in accordance with BS2050:1978 (1998) 4.12.
- Working temperature -15°C to +60°C.
- Applicable Standards BS EN ISO 6224:2011, BS EN ISO 5774:2008, BS EN ISO 8031:2009



Model	Hose inside dia		Hose outside dia		Max working pressure ^a bar	Max rec. air flow l/s	Weight per 30 m coil kg	Ordering No.
	mm	in	mm	in				
CABLAIR ESD 06	6	1/4	11	7/16	10	4	2.34	8202 0501 06
CABLAIR ESD 08	8	5/16	12	1/2	9	7.5	2.56	8202 0501 08
CABLAIR ESD 10	10	3/8	14	9/16	8	13	2.71	8202 0501 10
CABLAIR ESD 13	13	1/2	18	23/32	7	21	4.41	8202 0501 13

^a With a safety factor of 3 at 20°C (at the max temp of +60°C the working pressure should be reduced by 50%).

PVC hoses

Strong PVC hose for heavy-duty applications

PVC hose has high resistance to abrasion, which makes it the ideal hose for tough working environments such as workshops, factories, garages, etc. It is mainly recommended for indoor use.

- Long service life.
- Pliable.
- Transparent.
- Working temperature -15°C to +60°C.
- Applicable Standards BS EN ISO 6224:2011, BS EN ISO 5774:2008

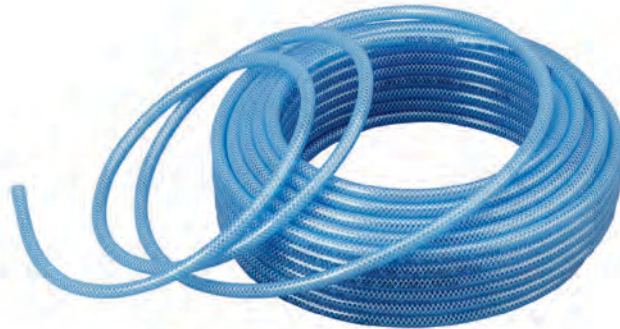

Model	Hose inside dia		Hose outside dia mm	Max working pressure ^a bar	Max rec. air flow ^b l/s	Weight per 30 m coil kg	Ordering No.
	mm	in					
PVC 03	3.2	1/8	7	20	0.7	1.4	9093 0037 21
PVC 05	5	3/16	9	10	2.1	1.9	9093 0037 51
PVC 06	6.3	1/4	11	10	4	2.5	9093 0037 81
PVC 08	8	5/16	12	10	7.5	2.9	9093 0038 11
PVC 10	10	3/8	14	14	13	3.7	9093 0038 41
PVC 13	12.5	1/2	18	13	21	5.9	9093 0038 71
PVC 16	16	5/8	22	12	43	7.2	9093 0039 01
PVC 20	19	3/4	25	10	75	8.3	9093 0039 31
PVC 25	25	1	32	10	125	12.5	9093 0039 61

^a With a safety factor of 3 at 20°C (at the max temp of +60°C the working pressure should be reduced by 50%).

^b The pressure drop will be 0.2 bar on a hose length of 5 m.

POLUR

High resistant polyurethane hose

Polur hose is the most environmentally friendly solution. It has high resistance to abrasion and it is oil resistant. Polur hose has a much longer lifetime than PVC hoses. Polur is ideal in tough working conditions such as workshops, factories, garages, shipyards and construction sites due to its flexibility, even at minus degrees. Polur is recommended for indoor and outdoor use.

- Oil resistant.
- Flexible.
- Long service life.
- Working temperature -30°C to +60°C.



Model	Hose inside dia		Hose outside dia mm	Max working pressure ^a bar	Max rec. air flow ^b l/s	Weight per 25 m coil kg	Ordering No.
	mm	in					
POLUR 08	8	5/16	12	20	7.5	2.2	8202 0601 08
POLUR 10	10	3/8	14	16	13	2.5	8202 0602 10
POLUR 13	13	1/2	18	13	21	4.0	8202 0603 13

^a With a safety factor of 3 at 20°C (at the max temp of +60°C the working pressure should be reduced by 50%).

^b The pressure drop will be 0.2 bar on a hose length of 5 m, including 2 nipples and at an inlet pressure of 7 bar.

TURBO

Super-light flexible rubber hose

Turbo hose has been developed for flexible use both indoor and outdoor. The hose weighs 30-40% less than conventional rubber hoses, making it ideal for foundries, shipyards, engineering workshops and construction sites. Turbo hose is oil resistant.

- Extremely low weight.
- Soft and flexible.
- Antistatic.
- Grinding and welding spatter resistant.
- Working temperature -30°C to +70°C.



Model	Hose inside dia		Hose outside dia mm	Max working pressure ^a bar	Max rec. air flow ^b l/s	Weight per		Ordering No.
	mm	in				20 m coil kg	30 m coil kg	
TURBO 13	13	1/2	19	20	21	3.9	–	9093 0057 91
TURBO 13	13	1/2	19	20	21	–	5.9	9093 0057 93
TURBO 16	16.8	2/3	22.8	20	43	4.8	–	9093 0057 31
TURBO 16	16.8	2/3	22.8	20	43	–	7.2	9093 0057 33
TURBO 20	21	5/6	27	20	75	5.4	–	9093 0057 61

^a With a safety factor of 4 at 20°C.

^b The pressure drop will be 0.2 bar on a hose length of 5 m, including 2 nipples and at an inlet pressure of 7 bar.

RUBBER

Durable reinforced extra thick heavy duty rubber hose

The hose withstands rough handling and is suitable for the most demanding tasks in construction, mining, shipyards, foundries etc. The inner lining is black EPDM rubber, conductive to dissipate static electricity. Reinforcement with high tensile strength made of synthetic textile yarns.

- Durable.
- Antistatic.
- Grinding and welding spatter resistant.
- Working temperature -25°C to +70°C.



Model	Hose inside dia		Hose outside dia mm	Max working pressure ^a bar	Max rec. air flow ^b l/s	Length m	Weight kg	Ordering No.
	mm	in						
RUBBER	6.3	1/4	12	16	4	30	3.5	9030 2036 00
RUBBER	10	3/8	17	16	13	30	6.9	9030 2037 00
RUBBER	12.5	1/2	22	16	21	30	12.3	9030 2038 00
RUBBER	16	5/8	25	16	43	30	13.9	9030 2039 00
RUBBER	20	3/4	30	16	75	30	19.3	9030 2040 00
RUBBER	20	3/4	30	16	75	20	12.9	9030 2040 03
RUBBER	25	1	36	16	125	30	24.0	9030 2041 00
RUBBER	25	1	36	16	125	20	16.0	9030 2041 03

^a With a safety factor of 5 at 20°C.

^b The pressure drop will be 0.2 bar on a hose length of 5 m, including 2 nipples and at an inlet pressure of 7 bar.

RUBAIR

Durable reinforced heavy duty rubber hose

Rubair hose is double reinforced to fulfil all general heavy duty demands and is recommended for indoor and outdoor use. Rubair hose is oil resistant.

- Durable.
- Antistatic.
- Grinding and welding spatter resistant.
- Working temperature -20°C to +80°C.



Model	Hose inside dia		Hose outside dia mm	Max working pressure ^a bar	Max rec. air flow ^b l/s	Weight per 20 m coil kg	Ordering No.
	mm	in					
RUBAIR 10	10	3/8	16.0	16	13	3.6	8202 0402 10
RUBAIR 13	12.5	1/2	19.1	16	21	4.7	8202 0403 13
RUBAIR 16	16	5/8	23.0	16	43	6.1	8202 0404 16
RUBAIR 20	20	3/4	26.6	16	75	7.8	8202 0405 20
RUBAIR 25	25	1	34.0	16	125	11.8	8202 0406 25

^a With a safety factor of 5 at 20°C.

^b The pressure drop will be 0.2 bar on a hose length of 5 m, including 2 nipples and at an inlet pressure of 7 bar.

SPI

Elastic hose for vertical and horizontal applications

SPI elastic spiral hose is ideal for air tools used at varying distances from a fixed air outlet. It is easily stretched and retracts immediately when released. When used with hand tools, its self-storage principle ensures that the hose is kept off the floor and out of the way of the operator. The SPI 1 and SPI 2 have ball bearing swivels fitted on the long hose side to allow 360° rotation. All spiral hoses, except the SPI4, are fitted with plastic spring guard. SPI is the ideal hose in combination with a balancer.

- Self-retractable.
- Light and flexible.
- Strong and durable.
- Tubing material: Polyurethane (100% PUR).
- Hardness: Shore A 98 +2.
- Colour: Blue.
- Working pressure: 8 bar at 23°C.
- Burst pressure: 25 bar at 23°C.
- Temperature range: -40°C to +70°C.



Dimensions

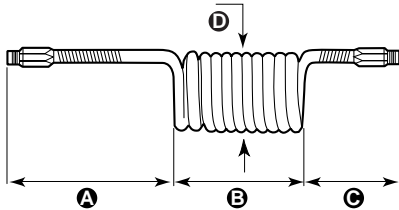

Model	Hose inside dia mm	Hose outside dia mm	Max. rec. air flow ^a l/s	Working range m	Length			Max spiral dia (D) mm	Male threads in BSP	Ordering No.
					(A) mm	(B) mm	(C) mm			
SPI 1SPSW-S	6.5	10	7	2	500	165	150	55	1/4	8202 0508 71
SPI 1SPSW-M	6.5	10	5	4	500	330	150	55	1/4	8202 0508 73
SPI 2SPSW-S	8	12	13	2	500	130	150	70	3/8	8202 0508 75
SPI 2SPSW-M	8	12	10	4	500	270	150	70	3/8	8202 0508 77
SPI 2SPSW-L	8	12	9	6	500	435	150	70	3/8	8202 0508 79
SPI 2SPSW-XL	8	12	6	8	500	600	150	70	3/8	8202 0508 81
SPI 3SP-S	11	16	25	2	500	185	150	98	3/8	8202 0508 82
SPI 3SP-M	11	16	22	4	500	250	150	98	3/8	8202 0508 84
SPI 3SP-L	11	16	17	6	500	390	150	98	3/8	8202 0508 86
SPI 3SP-XL	11	16	13	8	500	550	150	98	3/8	8202 0508 88
SPI 4SP-XXL	13	19	21	10	500	850	500	115	3/8	8202 0508 90

^a At inlet pressure 6 bar and pressure drop 0.5 bar.

Productivity kits boost productivity, extend tool lifetime and ensure minimum pressure drop.

Each productivity kit includes ball valve, air preparation unit, and the couplings, hose and nipples needed for correct and safe installation of the tool.

Just choose the correct productivity kit based on the air flow requirement of the tool and whether the tool needs lubrication or not. You'll be surprised how much the productivity kit improves the performance of the tool.

- Improves the performance of the tool.
- Fast and easy installation.
- Extends tool lifetime.



Productivity kits for screwdrivers, drills and grinders

Model	Max air flow	Hose, 5 m	Coupling	Lubrication	Ordering No.
For small screwdrivers and small drills with 1/8" BSP air inlet					
MIDI Optimizer F/RD EQ08-C06-1/8	6 l/s	Cablair 6 mm	ErgoQIC 08	Yes	8202 0850 10
MIDI Optimizer F/R EQ08-C06-1/8	6 l/s	Cablair 6 mm	ErgoQIC 08	No	8202 0850 19
For small screwdrivers and small drills with 1/4" BSP air inlet					
MIDI Optimizer F/RD EQ08-C06	6 l/s	Cablair 6 mm	ErgoQIC 08	Yes	8202 0850 06
For screwdrivers and drills with 1/4" BSP air inlet					
MIDI Optimizer F/RD EQ08-C08	9 l/s	Cablair 8 mm	ErgoQIC 08	Yes	8202 0850 00
MIDI Optimizer F/R EQ08-C08	9 l/s	Cablair 8 mm	ErgoQIC 08	No	8202 0850 01
For 1/2" drills and small nutrunners with 3/8" BSP air inlet					
MIDI Optimizer F/RD EQ08-C10	16 l/s	Cablair 10 mm	ErgoQIC 08	Yes	8202 0850 07
For 1/2" small nutrunners with 1/4" BSP air inlet					
MIDI Optimizer F/RD EQ08-C10	16 l/s	Cablair 10 mm	ErgoQIC 08	Yes	8202 0850 03
MIDI Optimizer F/RD EQ10-R10	16 l/s	Rubber 10 mm	ErgoQIC 10	Yes	8202 0850 16
For percussive tools and grinders with 3/8" BSP air inlet incl. whiphose					
MIDI Optimizer F/RD EQ10-R13-W	23 l/s	Rubber 13 mm	ErgoQIC 10	Yes	8202 0850 14
For percussive tools and grinders, incl. whiphose, no tool nipple included					
MIDI Optimizer F/RD EQ10-R13-W	23 l/s	Rubber 13 mm	ErgoQIC 10	Yes	8202 0850 15
For drills and nutrunners with 3/8" BSP air inlet					
MIDI Optimizer F/RD EQ10-C13	23 l/s	Cablair 13 mm	ErgoQIC 10	Yes	8202 0850 02
For drills and nutrunners with 1/4" BSP air inlet					
MIDI Optimizer F/RD EQ10-C13-1/4	23 l/s	Cablair 13 mm	ErgoQIC 10	Yes	8202 0850 11
For grinders and nutrunners with 3/8" BSP air inlet					
MIDI Optimizer F/RD EQ10-T13	35 l/s	Turbo 13 mm	ErgoQIC 10	Yes	8202 0850 17
For grinders and nutrunners with 1/2" BSP air inlet					
MIDI Optimizer F/R EQ10-T13	35 l/s	Turbo 13 mm	ErgoQIC 10	No	8202 0850 04
MIDI Optimizer F/RD EQ10-T13	35 l/s	Turbo 13 mm	ErgoQIC 10	Yes	8202 0850 13
For grinders with 1/2" BSP air inlet					
MIDI Optimizer F/RD EQ10-T16	40 l/s	Turbo 16 mm	ErgoQIC 10	Yes	8202 0850 12
For large Turbo grinders with 1/2" BSP air inlet					
MAXI F/R C-T16	60 l/s	Turbo 16 mm	Claw	No	8202 0850 05
For large Turbo grinders with 1/2" BSP air inlet					
MAXI F/RD C-T20	65 l/s	Turbo 20 mm	Claw	Yes	8202 0850 20

Productivity kits for impact wrenches and pulse tools

Model	Max air flow	Hose, 5 m	Coupling	Lubrication	Ordering No.
For small impacts and pulse tools with 1/4" BSP air inlet					
MIDI Optimizer F/RD EP EQ08-C08	9 l/s	Cablair 8 mm	ErgoQIC 08	Yes	8202 0850 35
For 1/2" impact wrenches and pulse tools with 3/8" BSP air inlet					
MIDI Optimizer F/RD EQ08-C10	16 l/s	Cablair 10 mm	ErgoQIC 08	Yes	8202 0850 36
For 1/2" impact wrenches and pulse tools with 1/4" BSP air inlet					
MIDI Optimizer F/RD EQ08-C10	16 l/s	Cablair 10 mm	ErgoQIC 08	Yes	8202 0850 37
MIDI Optimizer F/RD EQ10-R10	16 l/s	Rubber 10 mm	ErgoQIC 10	Yes	8202 0850 38
For impact wrenches and pulse tools with 3/8" BSP air inlet					
MIDI Optimizer F/RD EQ10-C13	23 l/s	Cablair 13 mm	ErgoQIC 10	Yes	8202 0850 39
For impact wrenches and pulse tools with 1/2" BSP air inlet					
MIDI Optimizer F/RD EQ10-T13	35 l/s	Turbo 13 mm	ErgoQIC 10	Yes	8202 0850 41

Pre-mounted Hose Kits

Pre-mounted hose kits

Atlas Copco hose kits provides an easy way to choose the right hose and coupling combination for pneumatic tools. Each kit is ready for immediate use without the need of assembly tools.

- Correct combination hose – coupling.
- Leak free hose connections.
- Immediate use.



Hose kits

Hose	Dia mm	Length m	Nipple	Coupling	Air inlet thread nipple	Ordering No.
Cablaire	6	5	ErgoNIP 08	ErgoQIC 08	-	8202 1182 01
Cablaire	6	5	NIP 08	ErgoQIC 08US	-	8202 1182 16
Cablaire	6	5	ErgoNIP 10	ErgoQIC 10	1/8" BSP	8202 1180 67
Cablaire	6	5	ErgoNIP 10	ErgoQIC 10	1/4" BSP	8202 1182 01
Cablaire	8	5	ErgoNIP 08	ErgoQIC 08	1/4" BSP	8202 1182 02
Cablaire	8	5	NIP 08	ErgoQIC 08US	-	8202 1182 21
Cablaire	8	5	ErgoNIP 10	ErgoQIC 08	1/4" BSP	8202 1180 77
Cablaire	10	1.5	ErgoNIP 10	ErgoQIC 10	-	8202 1182 25
Cablaire	10	5	ErgoNIP 08	ErgoQIC 08	1/4" BSP	8202 1182 03
Cablaire	10	5	ErgoNIP 10	ErgoQIC 10	-	8202 1182 05
Cablaire	10	5	NIP 10US	ErgoQIC 10US	-	8202 1182 17
Cablaire	10	5	ErgoNIP 10	ErgoQIC 10	1/8" BSP	8202 1180 30
Cablaire	13	5	ErgoNIP 10	ErgoQIC 10	3/8" BSP	8202 1180 79
Cablaire	13	5	ErgoNIP 10	ErgoQIC 10	-	8202 1182 10
Cablaire	13	5	NIP 10US	ErgoQIC 10US	-	8202 1182 18
Cablaire	13	8.5	ErgoNIP 10	ErgoQIC 10	-	8202 1182 20
Cablaire	13	10	ErgoNIP 10	ErgoQIC 10	-	8202 1182 15
PVC	10	5	ErgoNIP 10	ErgoQIC 10	1/4" BSP	8202 1180 18
PVC	10	5	ErgoNIP 10	ErgoQIC 08	3/8" BSP	8202 1180 31
Rubber	10	5	ErgoNIP 10	ErgoQIC 10	3/8" BSP	8202 1180 20
Rubber	10	5	NIP 10US	ErgoQIC 10US	-	8202 1182 23
Rubber	10	5	ErgoNIP 10	ErgoQIC 10	1/4" BSP	8202 1180 43
Rubber	13	5	NIP 10US	ErgoQIC 10US	-	8202 1182 24
Rubber	20	5	CLAW	ErgoQIC 10	-	8202 1180 24
Rubber	20	5	CLAW	CLAW	-	8202 1180 29
Turbo	13	5	ErgoNIP 10	ErgoQIC 10	1/2" BSP	8202 1180 22
Turbo	13	5	NIP 10US	ErgoQIC 10US	-	8202 1182 19
Turbo	16	5	ErgoNIP 10	ErgoQIC 10	-	8202 1180 34
Turbo	16	5	CLAW	ErgoQIC 10	1/2" BSP	8202 1181 80
Turbo	16	5	NIP 15US	ErgoQIC 15US	-	8202 1182 22
Turbo	16	10	ErgoNIP 10	ErgoQIC 10	-	8202 1180 46
Turbo	20	20	CLAW	ErgoQIC 10	-	8202 1181 75



Whip hose kits

Hose	Dia mm	Length m	Nipple	Male thread	Ordering No.
Cablaire	10	0.7	ErgoNIP 10	1/4" BSPT	8202 1180 19
Cablaire	10	1.5	ErgoNIP 10	1/4" BSPT	8202 1182 30
Cablaire	10	1.5	ErgoNIP 10	3/8" BSPT	8202 1182 35
Cablaire	10	0.7	ErgoNIP 08	1/4" BSPT	8202 1180 47
PVC	10	0.7	ErgoNIP 08	3/8" BSPT	8202 1180 50
Rubber	10	0.7	ErgoNIP 10	1/4" BSPT	8202 1180 42
Rubber	10	0.7	ErgoNIP 10	3/8" BSPT	8202 1180 44
Rubber	13	0.7	ErgoNIP 10	1/2" BSPT	8202 1180 23
Rubber	16	0.5	ErgoNIP 10	1/2" BSPT	8202 1180 28
Rubber	16	0.5	CLAW	1/2" BSPT	8202 1180 37
Turbo	16	5	CLAW	1/2" BSPT	8202 1181 95

HM LIGHT

The HM Light has a composite casing and a highly wear and oil resistant PUR hose. The HM Light hose reel is recommended for small screwdrivers and small pulse tools.

- Revolving hinge for flexible use.
- Light and compact.
- Kink resistant PUR-hose.
- Working temperature: -30°C - +60°C.
- Max working pressure is 20 bar.
- Inlet hose length: 0.9 m.



Dimensions

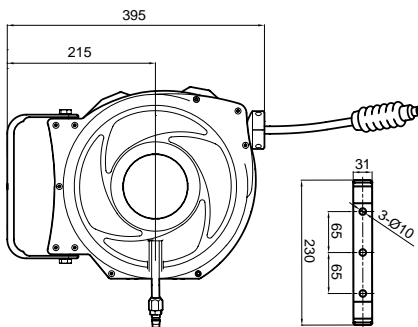

Model	Length m	Hose	Hose inside dia		Connection inlet BSP male	Connection distribution hose BSP		Air flow l/s	Weight kg	Ordering No.
			mm	in		male	male			
HM LIGHT	10	PUR	8	5/16	1/4	1/4	9	4.5	8202 1180 91	

HM FLEX

The HM FLEX has a high quality, compact steel casing and is recommended for small and medium screwdrivers, small and medium pulse tools, small drills, impact wrenches up to 1/2" size, small grinders and riveting and chipping hammers.



Dimensions

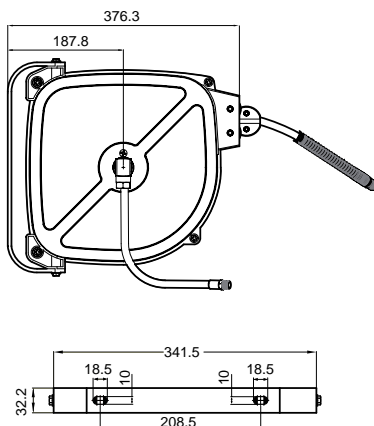

- HM FLEX Grinding with spatter resistant rubber hose.
- Revolving hinge for flexible use.
- Strong and durable.
- Working temperature: -30°C - +60°C.
- Max working pressure: 20 bar.
- Inlet hose length: 1.5 m.

Model	Length m	Hose	Hose inside dia		Connection inlet BSP male	Connection distribution hose BSP		Air flow l/s	Weight kg	Ordering No.
			mm	in		male	male			
HM FLEX Grinding	8	Rubber	8	5/16	1/4	1/4	9	8.5	8202 1181 02	
HM FLEX	10	PUR	10	3/8	1/4	1/4	14	8.5	8202 1181 00	

HM OPEN FLEX

Hose reels in the HM Open Flex series have an open steel casing and 10 mm or 13 mm hose. HM Open Flex hose reels are recommended for screwdrivers, impact wrenches, pulse tools, drills, chipping and riveting hammers and grinders up to 1000 W.

- Kink resistant PUR hose or spatter resistant rubber hose.
- Floor, wall or ceiling mounting.
- Revolving hinge for flexible use.
- Working temperature: -30°C - +60°C.
- Max working pressure: 20 bar.
- Inlet hose length: 1.5 m.



Model	Length m	Hose	Hose inside dia		Connection distribution			Air flow l/s	Weight kg	Ordering No.
			mm	in	inlet BSP male	hose BSP male				
HM OPEN FLEX	10	PUR	10	3/8	3/8	3/8	12	10.5	8202 1181 12	
HM OPEN FLEX	15	PUR	10	3/8	3/8	3/8	8	11	8202 1181 10	
HM OPEN FLEX	15	Rubber	10	3/8	3/8	3/8	8	11	8202 1181 09	
HM OPEN FLEX L	10	PUR	13	1/2	1/2	1/2	16	13	8202 1181 22	
HM OPEN FLEX L	15	PUR	13	1/2	1/2	1/2	14	14	8202 1181 20	
HM OPEN FLEX L	15	Rubber	13	1/2	1/2	1/2	14	14	8202 1181 14	

Dimensions

HM OPEN FLEX

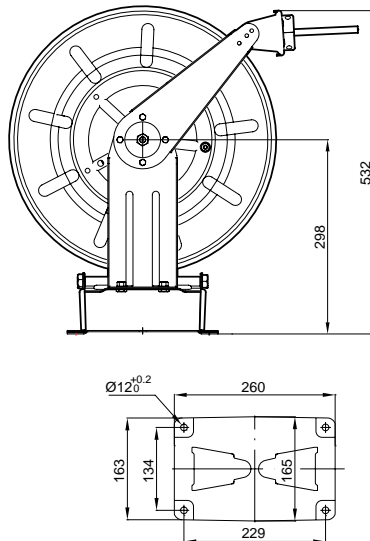

HM OPEN FLEX L

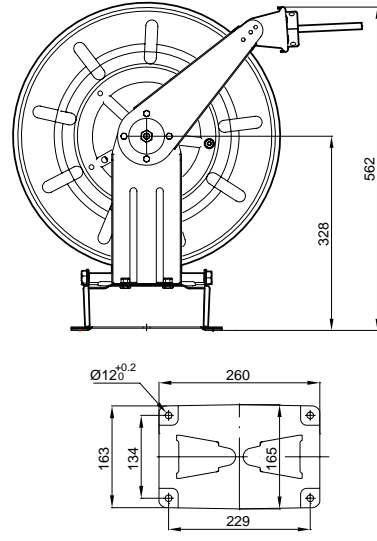

HM FLEX L

The HM FLEX L, with a steel casing and high quality rubber hose, handles both air and water. The HM FLEX L is recommended for all screwdrivers, pulse tools, impact wrenches, drills, chipping and riveting hammers and grinders up to 1000 W.

- NBR rubber hose.
- Movable brackets for floor, wall and ceiling mounting.
- High flow capacity.
- Working temperature: -30°C - +60°C.
- Max working pressure is 15 bar.
- Inlet hose length: 1 m.



Dimensions

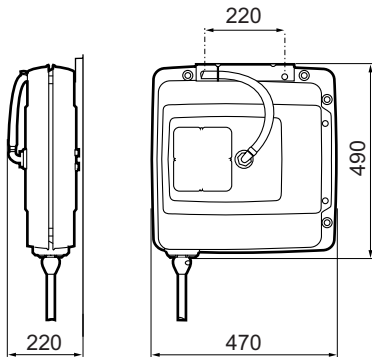

Model	Length m	Hose	Hose inside dia		Connection inlet BSP	Connection distribution hose BSP	Air flow l/s	Weight kg	Ordering No.
			mm	in	male	male			
HM FLEX L	10	Rubber	12.5	1/2	1/2	1/2	22	16	8202 1181 56

HM TURBO and HM XL

The HM Turbo and HM XL have an open steel casing with 20 mm Turbo hose or 25 mm rubber hose. The HM Turbo and HM XL are recommended for use with high powered grinders.

- Spatter resistant hoses.
- Extremely high flow capacity.
- Floor, wall or ceiling mounting.
- Revolving hinge for flexible use.
- Working temperature: -30°C - +60°C.
- Max working pressure: 20 bar.
- No hose, inlet coupling on casing.



Dimensions

Model	L	H	W
HM TURBO	660	765	340

Model	Length m	Hose	Hose inside dia		Connection inlet BSP	Connection distribution hose BSP	Air flow l/s	Weight kg	Ordering No.
			mm	in	male	male			
HM Turbo	20	TURBO	20	3/4	3/4	No thread	50	42	8202 1181 30
HM XL	15	Rubber	25	1	1	No thread	60	42	8202 1181 33

Hose reel balancer – HRIL

Models in the HRIL range of hose reel balancers are specifically designed for use with small pneumatic hand tools.

The integrated air hose and support cable ensure the work area is kept tidy and the tool is easy to control.

- Ergonomics – The retraction force over hose travel remains almost constant which minimizes load on the operator and ensures smooth operation.
- An easily adjusted rubber stop is fitted on the hose which allows the tool to be set at the optimum position.
- The retraction force is easily adjustable by means of a hand wheel on the rear casing (this can be removed if desired, once the retraction force is set).
- Long service life – The design features a rugged casing, self lubricating spindle bearing bushes and a 360 degrees rotary inlet connector.
- A durable hose is fitted with additional protection to prevent excessive bending around air connectors.
- Low pressure drop – The HRIL balancers have very good flow characteristics.



Model	Capacity range		Max rec. air flow ^a l/s	Hose travel m	Weight		Max working pressure bar	Dimensions			Ordering No.
	kg	lb			kg	lb		A mm	B mm	C mm	
HRIL 1	0.2-0.5	0.4-1.1	3.5	1.2	1.2	2.6	10	92	132	173	8202 0600 03
HRIL 3	0.5-1.4	1.1-3.1	5.5	1.0	1.2	2.6	10	92	132	173	8202 0600 11
HRIL 4	0.7-2.0	1.5-4.4	6.5	1.0	1.4	3.1	10	92	132	173	8202 0600 29

^a At inlet pressure of 6 bar pressure drop is 0.4 bar.

Air line fittings

All models have a BSP 1/4" inlet fitting.

HRIL 1 supplied with M5 and BSP 1/8" outlet fittings.

HRIL 3 supplied with BSP 1/8" and BSP 1/4" outlet fittings.

HRIL 4 supplied with BSP 1/4" outlet fitting.

Dimensions

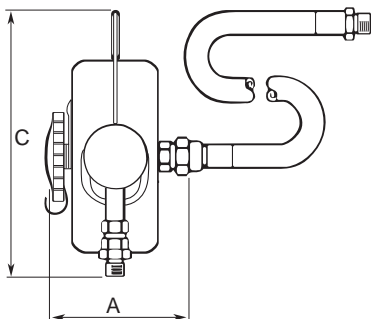
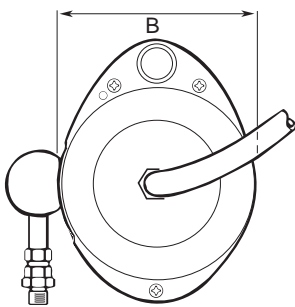

Optional Accessories

Designation	Ordering No.
Safety chain	4391 4045 90

COLIBRI – COL

Balancers in the unique COL range hold the load and keep it weightless throughout the entire cable length.

Productivity

COL balancers always hold the tool in the correct position

Ergonomic

COL balancers reduce the stress level in the operator's muscles.

Safety

The load is not pulled back when released and the surroundings are protected from accidental hoisting of the load.

The cable locks in the event of spring failure (downward braking power).

In all models the braking function can be activated upwards by using the "bow and arrow" principle if you need to slacken the cable to change the tool.

COLIBRI S

The COL S models feature an extra safety brake mechanism (double braking system) for applications with extremely high safety requirements.



Dimensions

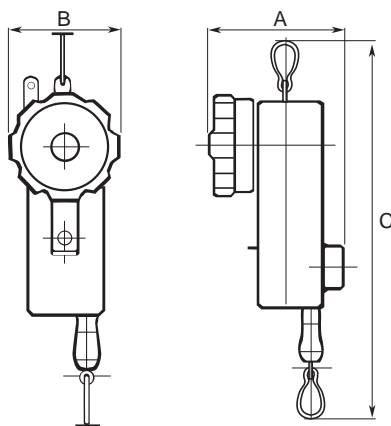

Model	Capacity range		Cable length m	Weight		Dimensions			Ordering No.
	kg	lb		kg	lb	A mm	B mm	C mm	
COL 1 01	0.7-1.3	1.5-2.9	1.7	0.5	1.1	108	72	245	8202 0750 01
COL 1 02	1.0-2.0	2.2-4.4	1.7	0.5	1.1	108	72	245	8202 0750 19
COL 2 03	1.7-3.5	3.7-7.7	2.4	2.3	5.1	155	116	427	8202 0750 27
COL 2 04	3.0-6.0	6.6-13.2	2.4	2.3	5.1	155	116	427	8202 0750 35
COL 2 05	4.7-7.0	10.4-15.4	2.4	2.5	5.5	155	116	427	8202 0750 43
COL 3 07	5.5-9.0	12.1-19.8	2.4	3.3	7.3	196	116	427	8202 0750 50
COL 3 10	8.0-13.0	17.6-28.7	2.4	3.4	7.5	196	116	427	8202 0750 68
COL 3 15	12.5-17.0	27.6-37.5	2.4	3.8	8.4	196	116	427	8202 0750 76
COL 4 18	14.0-22.0	30.9-48.5	2.4	13.2	29.1	244	193	620	8202 0774 11
COL 4 22	17.0-28.0	37.4-61.7	2.4	13.9	30.6	244	193	620	8202 0750 84
COL 4 30	24.0-38.0	52.9-83.8	2.4	14.5	32.0	244	193	620	8202 0750 92
COL 4 42	36.0-49.0	79.4-107.8	2.4	14.9	32.8	244	193	620	8202 0751 00
COL 4 50	43.0-55.0	98.4-121.3	2.4	15.3	33.7	244	193	620	8202 0751 18
Safety brake									
COL 2 03S	1.7-3.5	3.7-7.7	2.4	2.3	5.1	155	116	427	8202 0775 93
COL 2 04S	3.0-6.0	6.6-13.2	2.4	2.3	5.1	155	116	427	8202 0776 01
COL 2 05S	4.7-7.0	10.4-15.4	2.4	2.5	5.3	155	116	427	8202 0776 19
COL 3 07S	5.5-9.0	12.1-19.8	2.4	3.3	7.3	196	116	427	8202 0776 27
COL 3 10S	8.0-13.0	17.6-28.7	2.4	3.4	7.5	196	116	427	8202 0776 35
COL 3 15S	12.5-17.0	27.6-37.5	2.4	3.8	8.4	196	116	427	8202 0776 43

NOTE: COL 1 01 and COL 1 02 comes with nylon cable. All other models are equipped with steel wire.

Optional Accessories

Safety chain

	Ordering No.
COL 1	4391 4045 90
COL 2 and 3	4391 4046 90
COL 4	4391 4047 90

RIL balancer

RIL balancers always keep the tool in place, handy and easily accessible. RIL balancers are available as retractors or weightless positioning balancers.

RIL Retractors

- Adjustable wire stop.
- High quality spring and construction.
- Load range 0 to 10 kg.

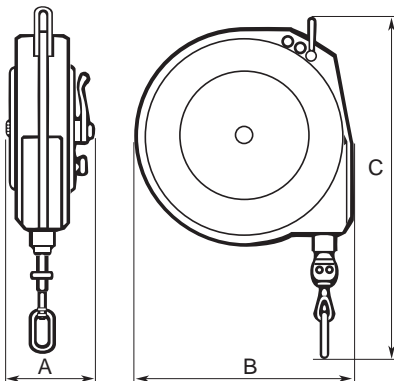
**Dimensions**

Model	Capacity range		Cable length m	Weight		Dimensions			Ordering No.
	kg	lb		kg	lb	A mm	B mm	C mm	
Retractors									
RIL 1C	0.0-0.5	0.0-1.7	1.5	0.6	1.3	51	106	238	8202 0700 02
RIL 2C	0.4-1.0	0.9-2.2	1.5	0.6	1.3	51	106	238	8202 0701 19
RIL 4C	1.0-2.0	2.2-4.4	1.5	0.6	1.3	51	106	238	8202 0702 18
RIL 5C	1.4-2.3	3.1-5.1	1.5	0.6	1.3	51	106	238	8202 0703 25
RIL 5	0.4-2.3	0.9-5.1	2.4	2.0	4.4	70	157	308	8202 0703 09
RIL 5LR ^b	0.4-2.3	0.9-5.1	2.4	2.0	4.4	70	157	308	8202 0703 15
RIL 10C	2.0-5.0	4.4-11.0	2.4	2.7	6.0	84	190	369	8202 0704 16
RIL 10CS ^a	2.0-5.0	4.4-11.0	2.4	2.7	6.0	84	190	369	8202 0704 20
RIL 15C	5.0-7.0	11.0-15.4	2.4	3.2	7.1	84	190	369	8202 0705 15
RIL 15CS ^a	5.0-7.0	11.0-15.4	2.4	3.2	7.1	84	190	369	8202 0705 20
RIL 22C	6.0-10.0	13.2-22.0	2.4	3.2	7.1	84	190	369	8202 0706 14
RIL 22CS ^a	6.0-10.0	13.2-22.0	2.4	3.2	7.1	84	190	369	8202 0706 20

^a Balancer equipped with automatic safety drum lock in case of spring failure. Safety chain included.

^b Contains a lock ratchet to lock the cable in increments along its entire length.

NOTE: RIL 1C, 2C, 4C and 5C comes with nylon cable. All other models are equipped with steel wire.

Optional Accessories**Safety chain**

	Ordering No.
1C, 2C, 4C and 5C	4391 4045 90
10C ^a , 15C ^a and 22C ^a	4391 4156 00
5	4391 4046 90

^a Safety chain included.

WP balancer

Weightless positioning balancers with a cone-shaped drum hold the load and keep it weightless throughout the entire cable length.

Productivity

WP balancers always hold the tool in the correct position and minimize worker fatigue.

Ergonomic

WP balancers reduce stress level in the operator's muscles.

Safety

The load is not pulled back when released and the environment is protected from accidental hoisting of the load.

- Steel cable with cable stop buffer.
- Safety chain.
- Quick and easy cable replacement.



Dimensions

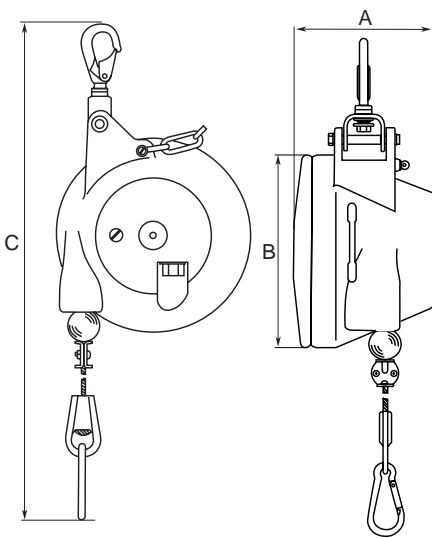

Model	Capacity range		Cable length m	Weight		Dimension			Ordering No.
	kg	lb		kg	lb	A mm	B mm	C mm	
WP 05-1	0.4-1.2	0.9-2.6	1.6	1.3	2.9	71	141	460	8202 0778 00
WP 05-3	1.2-2.6	2.6-5.7	1.6	1.4	3.1	71	141	460	8202 0778 01
WP 05-4	2.6-3.8	5.7-8.4	1.6	1.5	3.3	71	141	460	8202 0778 02
WP 05-5	3.8-5.2	8.4-11.5	1.6	1.5	3.3	71	141	460	8202 0778 03
WP 05-6	5.2-6.5	11.5-14.3	1.6	1.5	3.3	71	141	460	8202 0778 04
WP 10-3	3-5	6.6-11	2	2.9	6.4	130	188	521	8202 0779 00
WP 10-4.5	4.5-7	10-15.4	2	3.1	6.8	130	188	521	8202 0779 01
WP 10-6	6-10	13-22	2	3.2	7.0	130	188	521	8202 0779 02
WP 10-9	9-14	20-31	2	3.4	7.5	130	188	521	8202 0779 03
WP 10-13	13-17	29-37	2	3.6	8.0	130	188	521	8202 0779 04
WP 10-16	16-21	35-46	2	3.8	8.4	130	188	521	8202 0779 05
WP 20-15	15-25	33-55	2	7.8	17.2	152	218	521	8202 0780 00
WP 20-25	25-35	55-77	2	8.9	19.6	152	218	521	8202 0780 01
WP 20-35	35-45	77-99	2	9.5	21.0	152	218	521	8202 0780 02
WP 20-45	45-55	99-121	2	9.8	21.5	152	218	521	8202 0780 03
WP 30-12	12-20	26-44	2	14.8	32.6	203	285	749	8202 0781 00
WP 30-20	20-30	44-66	2	15.2	33.5	203	285	749	8202 0781 01
WP 30-30	30-45	66-99	2	16.9	37.3	203	285	749	8202 0781 02
WP 30-45	45-60	99-132	2	17.3	38.1	203	285	749	8202 0781 03
WP 30-60	60-75	132-165	2	18.7	41.2	203	285	749	8202 0781 04
WP 30-75	75-90	165-198	2	19.7	43.4	203	285	749	8202 0781 05
WP 30-90	90-100	198-220	2	19.9	43.4	203	285	749	8202 0781 06
WP 40-100	100-115	220-254	3	42.0	43.9	348	320	800	8202 0782 00
WP 40-115	115-130	254-287	3	44.0	97.0	348	320	800	8202 0782 01
WP 40-130	130-140	287-309	3	46.0	101	348	320	800	8202 0782 02
WP 40-140	140-150	309-331	3	48.0	106	348	320	800	8202 0782 03

Blow Gun BG-series

Atlas Copco blow guns BG-series are hard wearing, user friendly solution for all cleaning applications. The plastic body offer flexibility in handling for both left and right handed users, it insulate against cold and it reduce the risk of scratches to worksurfaces. The blow gun has excellent throttling properties allowing easy regulation of the air flow. The blow guns have air inlet thread in brass that is fully covered by the plastic body. Two versions available with star tip to reduce risk of damages or injuries if the tube is pressed against workpiece or skin.

- High flow capacity
- Suspension
- Plastic body to avoid scratches
- Air inlet thread in brass
- Star tip availability for improved safety



Model	Version	Working pressure bar	Air flow l/s	Weight		Air inlet thread BSP	Ordering No.
				kg	lb		
BG 2603-HF	Long tube, high flow	6.3	7.5	0.13	0.29	1/4	8202 1006 04
BG 2604-SHF	Short tube	6.3	4.3	0.12	0.26	1/4	8202 1006 05
BG 2605-STSS	Short tube, star tip	6.3	6.6	0.12	0.26	1/4	8202 1006 06
BG 2606-STS	Long tube, star tip, silencer	6.3	6.3	0.14	0.31	1/4	8202 1006 07

Air tool simulator

In order to check whether the pressure or the flow is sufficient the air tool simulator can be connected instead of the tool. The simulator is delivered with different connections.

Ordering No. 4145 0698 81.



Pressure control unit

The unit consists of a high quality pressure gauge and the necessary couplings for checking the air pressure at the air inlet of the machine.

Ordering No. 4145 0699 81.



Air leakage detector

The air leakage detector is used to find leaks (e.g. in compressed air installations, vacuum installations, etc.) It works by "listening" on a frequency band normally containing no interference and non-audible for humans (>20kHz). Leaking compressed air or electrical flashover (sparks) generate, e.g. ultrasonic sound.

The equipment is delivered in a suitcase and consists of: Detecting device, headphone set and directional probe.

Ordering No. 8202 9002 00.

AIRnet – Quality Piping Solution

AIRnet

AIRnet is a compressed air piping system that delivers quality air exactly where you need it, from compressor to the point of use.

- Fast: Thanks to a smart design and low weight materials, AIRnet can be installed 70% faster than conventional systems.
- Easy: AIRnet pipes and fittings are assembled in just a few steps by a single installer, without the need for heavy machinery.
- Reliable: Low friction and seamless connections of AIRnet minimize pressure drop thus effectively reduce the cost of ownership of your piping system.

GENERAL INFORMATION

Compliance

- EN 13480 / Directive 97/23/EC and ASME B31.1
- Complies with Common Pressure related approvals PED / CE / ASME / TUV
- Ø 20 / 25 / 40 / 50 / 63 / 80 / 100 mm
- 3/4", 1", 1 1/2", 2", 2 1/2", 3", 4"

Performance criteria

- Compatible with compressed air, Nitrogen.
- Maximum working pressure PN13 for temperatures between -20°C (-4°F) and +70°C (158°F).
- Operating temperature limits: -20°C (-4°F) / +70°C (158°F).
- Operating pressure: 20-80 mm 0.13-13 bar, 100 mm 0.13-16 bar.
- Lowest allowable pressure dewpoint: -70°C (-94°F).
- Resistant to the effect of compressor oils (mineral oil / PAO based / Ester based oils).
- AIRnet pipes are resistant to direct UV radiation and fittings are resistant to indirect UV radiation.
- Corrosion-free.
- Leak-resistant.
- Compatible with Oil Free and Oil Injected Compressors.
- Vacuum level: 20-80 mm 0.13 bar (1.88 psi) absolute pressure



Pipes

- Extruded aluminium UNS alloy A96063 T5.
- Maximum design pressure indication.
- Printed
Part number
Nominal diameter
Manufacture date



A cross-business areas project, initiated during 2012, enables Atlas Copco Tools to offer the AIRnet product range on request. Please contact your Atlas Copco Accessories contact to find out more.
The complete AIRnet product range including part numbers can be found in the separate AIRnet catalogue.



Air Motors

Contents	Page
Vane air motors	334
LZB vane air motors	335
LZL vane air motors.....	335
Air motor support.....	336

Introduction – Vane Air Motors

Air motors from Atlas Copco – the reliable, cost-effective solution when applying power to rotating machines. Consider the air motor features and characteristics giving large benefits to the designer:

- Power-to-weight performance that is superior to most other motors, in fact, 75% lighter and 85% smaller than an asynchronous electric motor with the same output.
- Can be held stalled at full torque indefinitely, and accepts repeated starting and stopping without limitation.
- Torque, speed and direction of rotation can be changed easily using simple control methods.
- Output that automatically adjusts to match the applied load.
- Controllable over a wide speed range.
- Ideal for many applications in hazardous or hostile environments.
- Smooth start-up to minimize “shock” loading on transmission components.
- Unaffected by, and will not generate, electrical interference.



Features for LZB motors

Lubrication-free air motors for sensitive processes where hygienic operation is crucial

Equipped with low friction vanes and sealed bearings the lubrication-free motors release no lubricants into the air. They offer a viable drive solution for sensitive processes and hygienic environments where oil contamination would be at best a problem and, at worst, a catastrophe.

Stainless steel air motors for harsh and aggressive environments

The stainless steel air motors are ideal for harsh or even aggressive environments where hygiene is essential. They have a “clean” design with no pockets where dirt can collect. They are fitted with double shaft seals to prevent water from entering the gears. Lubrication-free versions are also available.

High torque air motors when a real workhorse is needed

Fitted with extra strong planetary gears the high torque air motors provide torques up to 680 Nm. The gears are dimensioned to stand being loaded at full stall torque indefinitely. Despite their strength the high torque air motors are compact compared to solutions with helical or worm gears. Lubrication-free versions are also available.

Customized air motors to your individual specifications

Whatever the requirement, Atlas Copco is always happy to help customers find solutions to their special needs. For OEMs, for instance, a customized air motor can be the most efficient solution when integrating an air motor into a machine or a tool. Special motors may have unique casings or mounting arrangements. They may utilize non-standard materials or surface coatings and be designed to achieve a specific output.

For more information on Atlas Copco vane motors visit our web site.



Explosion proof certified versions

Our air motors are available in explosion proof certified versions, in compliance with the European Union's ATEX Directive on equipment for potentially explosive environments.

LZB**0.1 – 2.91 kW**

The Atlas Copco LZB vane air motors are compact in design, light in weight and available in a variety of different gear ratios to meet a variety of speed requirements. They are particularly suited to be built into hand held machines and also many different types of industrial equipment.



Model	Max output		Speed at max output r/min	Torque at max output		Min start torque		Free speed r/min	No. of gear ratios	Motor diameter	
	kW	hp		Nm	ft lb	Nm	ft lb			mm	in
Non-reversible											
LZB14	0.16	0.22	330 - 9100	0.17 - 4.7	0.12 - 3.4	0.26 - 7	0.19 - 5.1	690 - 19500	5	27	1.1
LZB22	0.25	0.34	235 - 9600	0.25 - 9.9	0.18 - 7.3	0.45 - 17	0.33 - 12.5	510 - 21500	7	36	1.4
LZB33	0.39	0.52	10 - 9400	0.40 - 340	0.30 - 251	0.76 - 680	0.56 - 501	21 - 20000	17	42	1.6
LZB42	0.65	0.87	25 - 10500	0.59 - 236	0.44 - 174	1.10 - 430	0.80 - 315	50 - 21000	12	46	1.8
LZB46	0.84	1.13	25 - 10800	0.74 - 300	0.55 - 220	1.20 - 490	0.88 - 360	50 - 21000	12	46	1.8
LZB54	1.20	1.61	65 - 9300	1.20 - 175	0.88 - 129	1.80 - 250	1.30 - 180	125 - 18000	10	60	2.4
LZB66	1.83	2.45	77 - 524	33 - 222	24 - 164	52 - 333	39 - 245	154 - 1026	7	60	2.4
LZB77	2.91	3.9	87 - 1325	21 - 314	15.5 - 231	30 - 471	22 - 347	174 - 2660	3	100	3.9
Reversible											
LZB14	0.10	0.14	230 - 6500	0.15 - 4.1	0.11 - 3.0	0.19 - 5	0.14 - 3.7	460 - 13000	5	27	1.1
LZB22	0.16	0.22	5 - 6500	0.24 - 10.8	0.18 - 8	0.35 - 13.4	0.26 - 9.9	5 - 13800	9	36	1.4
LZB33	0.24	0.32	7 - 7000	0.34 - 305	0.25 - 225	0.46 - 412	0.34 - 304	5 - 14000	21	42	1.6
LZB42	0.53	0.71	19 - 8100	0.62 - 250	0.46 - 184	0.70 - 270	0.52 - 200	37 - 16000	12	46	1.8
LZB46	0.62	0.83	20 - 8600	0.68 - 275	0.50 - 200	0.75 - 300	0.55 - 220	40 - 17000	12	46	1.8
LZB54	0.82	1.10	45 - 6800	1.20 - 165	0.88 - 122	1.30 - 179	1 - 132	90 - 13000	10	60	2.4
LZB66	1.43	1.92	70 - 473	29 - 190	22 - 141	46 - 308	33 - 227	130 - 875	7	60	2.4
LZB77	2.56	3.43	79 - 1250	20 - 304	15 - 224	29 - 456	21 - 336	158 - 2500	3	100	3.9

The LZB14, LZB22 and LZB33 models are available in lubrication-free versions. LZB14, LZB22 and LZB33 can be obtained in a stainless steel version. The standard non-reversible motors have clockwise rotation but can also be obtained with anti-clockwise rotation.

LZL**1.7 – 6.5 kW**

The Atlas Copco LZL vane motors are reversible air motors which have been designed to offer outstanding starting and low speed performance. These general purpose motors are powerful, durable and offer long service life.



Model	Torque at 3000 r/min		Power at 3000 r/min		Stall torque		Air consumption at 3000 r/min ^a		Max allowed speed r/min	Weight	
	Nm	ft lb	kW	hp	Nm	ft lb	l/s	cfm		kg	lb
LZL03 M	1.3	0.95	0.41	0.55	3.3	2.4	16	34	3000	2.9	6.4
LZL05 M	2.0	1.5	0.63	0.84	5.8	4.3	25	52	3000	3.9	8.6

^a Note that the air consumption in a typical mixing application normally is less than 50% of the values in the table.

LZL 03/05M – EX certified according to ATEX directive Ex II 2G T5 IIC D85° C.

LZL 03/05 available with IEC and Nema flange.

Model	Max output		Speed at max output r/min	Torque at max output		Min start torque		Free speed r/min	No. of gear ratios
	kW	hp		Nm	ft lb	Nm	ft lb		
Motor only									
LZL03 S	1.7	2.5	5300	2.2	1.6	3.0	2.2	11000	–
LZL05 S	2.1	2.8	4200	3.1	2.3	4.8	3.5	9000	–
LZL15	3.2	4.3	4500	6.8	5.0	10.9	8.0	7200	–
LZL25	5.0	6.7	4000	12.0	8.8	18.0	13.2	6000	–
LZL35	6.5	8.7	3100	20.0	14.7	32.0	23.6	5000	–
With helical gear unit									
LZL05	2.0	2.6	17 - 594	26 - 705	19 - 520	42 - 1112	31 - 820	37 - 1012	11
LZL15	3.0	4.1	17 - 495	58 - 1331	43 - 981	96 - 2134	71 - 1573	35 - 792	11
LZL25	4.8	6.4	14 - 438	103 - 2349	76 - 1732	159 - 3471	117 - 2560	29 - 657	11
LZL35	6.2	8.3	19 - 615	98 - 2459	72 - 1814	156 - 3935	115 - 2902	39 - 992	9

LZL 03/05S – Can be Ex certified according to the ATEX directive Ex II 2G T2 IIC D240° C.

Air Motor Support

Customized air motors to your individual specifications

Whatever the requirement, Atlas Copco is always happy to help customers find solutions to their special needs. For OEMs, for instance, a customized air motor can be the most efficient solution when integrating an air motor into a machine or tool.

Special motors may have unique casings or mounting arrangements. They may utilize non-standard materials or surface coatings and be designed to achieve a specific output.



Select your air motor in 30 seconds!

Designed for Windows-based PCs, Atlas Copco has developed an Air Motor Selection Guide. It stores data on all of Atlas Copco's air motors.

The designer specifies the required torques and speed of the motor and within seconds the program chooses the optimum motor. It also supplies complete documentation with performance curves and motor data.

Visit <http://www.atlascopco.com/airmotors/> to access the program.



Air motor drawing library

CAD-drawings of any of the hundreds of different Atlas Copco air motors are available to designers on CD or to download from Internet (in both 2D and 3D formats) from the Atlas Copco Air Motor Draw Library. These CAD-drawings can then be quickly and easily inserted into the designer's machine drawing.



When more information is required

For further information on Atlas Copco vane motors please ask for a copy of our Air Motor catalogue or browse to our Links and Downloads section on www.atlascopco.com to download the catalogue.



Hoists and Trolleys



Contents	Page
Air hoists.....	339
Trolleys.....	340
Accessories.....	341

Explosion-proof operation and stepless control for a smoother safer lift

Atlas Copco air hoists and trolleys are the industry benchmark for fast, precise and reliable lifting of heavy loads – even in cramped and sometimes hostile industrial environments.



Compact and lightweight, they are easy to control, survive rough handling and provide heavyweight performance.

Explosion proof for safe operation

Our air hoists and trolleys are ideal for lift applications in hazardous environments. All are certified Explosion-proof, to stringent European standards, in compliance with the EU ATEX Directive. Available in five sizes, they offer lift capacities from 250 kg to 5 tons. All hoists and trolleys are certified to level Ex II 2G T5 II B D100°C.

Simple installation

The trolleys are easy to install. The wheels are designed so that the trolley is equally suitable on both parallel and tapered I-beam section beams. The distance between the wheels is easily adjusted to suit the beam width by turning the suspension yoke.



Selection guide

Air hoist selection program

The fastest way to choose correct hoists and accessories is by using the Windows based computer program available on our website.

To order your hoist or trolley with accessories factory fitted, simply list all items required and add the

Ordering No. 8990 0001 00

EXAMPLE: To order a 500 kg hoist with motor driven trolley, four button five-metre long pendant control and a load chain for a ten-metre lift, send the following:

Order to be sent	Comments
1 x 8451 1540 28	LLA500 EX Hoist block
11 x 4310 2293 00	Load chain for hoist = Required height of lift + 0.5 m, (see technical data for LLA Hoists)
1 x 8451 1520 14	TLT1000MN Motor driven trolley
1 x 4310 2263 90	4 button handle + hoist actuator
5 x 4310 2310 96	Hose set for 4 button pendant control
1 x 8990 0001 00	Instruction to assemble above items

- **Precise and stepless speed control** – Through effective stepless control with excellent creep characteristics the LLA air hoists are fast to use over the entire speed range.
- **Heavy duty performance** – These air hoists can continually operate at maximum load with frequent start and stop cycles without risk of damage.
- **Elimination of load sink** – The patented brake mechanism eliminates load-sink when starting lifting, and automatically holds the load if the air supply fails.
- **Compact size** – The small dimensions make the LLA hoists easy to install, even in the most restricted space. Also the low weight means the hoists can easily be moved for maintenance or relocation purposes.
- **Lubrication free** – The complete range is also available in lubrication free versions.



Model	Max lifting capacity kg	Lifting speed at full load		Chain drops qty	Weight excl chain		Chain weight		Required chain-length metre	Air consumption		Hose size		Air inlet thread BSP	Ordering No.
		m/min	ft/min		kg	lb	kg/m	lb/ft		l/s	cfm	mm	in		
LLA250 EX	250	18.6	61.0	1	12.7	28.0	0.9	0.6	Lifting height + 0.5	37	78	12.5	1/2	1/2	8451 1540 10
LLA500 EX	500	12.6	41.3	1	12.7	28.0	0.9	0.6	Lifting height + 0.5	38	81	12.5	1/2	1/2	8451 1540 28
LLA980 EX ^a	980	6.3	20.7	2	15.0	33.0	0.9	0.6	2 x Lifting height + 0.5	38	81	12.5	1/2	1/2	8451 1560 07
LLA1000 EX	1000	6.3	20.7	2	15.0	33.0	0.9	0.6	2 x Lifting height + 0.5	38	81	12.5	1/2	1/2	8451 1540 36
LLA2500 EX	2500	3.2	10.5	1	42.5	93.7	2.9	1.9	Lifting height + 0.6	40	85	12.5	1/2	1/2	8451 1540 44
LLA5000 EX	5000	1.6	5.2	2	65.5	144.4	2.9	1.9	2 x Lifting height + 0.9	40	85	12.5	1/2	1/2	8451 1540 51
Lubrication free															
LLA250L EX	250	18.6	61.0	1	12.7	28.0	0.9	0.6	Lifting height + 0.5	37	78	12.5	1/2	1/2	8451 1550 17
LLA500L EX	500	12.6	41.3	1	12.7	28.0	0.9	0.6	Lifting height + 0.5	38	81	12.5	1/2	1/2	8451 1550 25
LLA980L EX ^a	980	6.3	20.7	2	14.5	32.0	0.9	0.6	2 x Lifting height + 0.5	38	81	12.5	1/2	1/2	8451 1560 15
LLA1000L EX	1000	6.3	20.7	2	15.0	33.0	0.9	0.6	2 x Lifting height + 0.5	38	81	12.5	1/2	1/2	8451 1550 32
LLA2500L EX	2500	3.2	10.5	1	42.5	93.7	2.9	1.9	Lifting height + 0.6	40	85	12.5	1/2	1/2	8451 1550 41
LLA5000L EX	5000	1.6	5.2	2	65.5	144.4	2.9	1.9	2 x Lifting height + 0.9	40	85	12.5	1/2	1/2	8451 1550 58

^a Without overload protection device.

NOTE: Load chain and control chain must be ordered separately. Performance figures are at 6 bar working pressure.

Dimensions

Model	A		B		C		D	
	mm	in	mm	in	mm	in	mm	in
LLA250 EX	377	14.8	122	4.8	390	15.4	29	1.1
LLA500 EX	377	14.8	122	4.8	390	15.4	29	1.1
LLA980 EX	445	17.5	122	4.8	390	15.4	29	1.1
LLA1000 EX	495	19.4	122	4.8	390	15.4	29	1.1
LLA2500 EX	575	22.6	212	8.3	546	21.5	50	2.0
LLA5000 EX	785	30.9	249	9.8	546	21.5	60	2.4

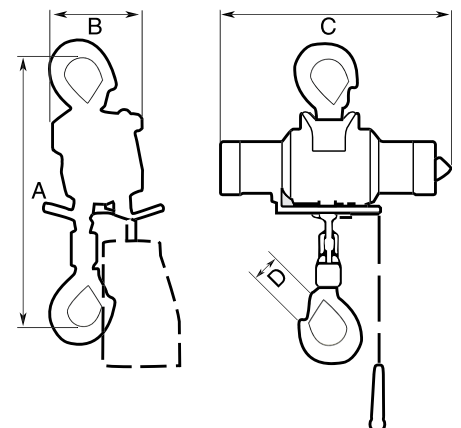

Atlas Copco trolleys are available in 3 sizes, for maximum loads of 1, 3 and 5 tonnes. All models can be offered with air motor drive. The 1 tonne trolley includes motor without pedant control. The 3 and 5 tonne includes handle for control chain (control chain must be ordered separately). The 1 and 3 tonne trolleys are also available in manual versions.



Model	Max capacity kg	Max speed with full load		Air consumption		Beam width		Curve radius min		Weight		Ordering No.
		m/min	ft/min	l/s	cfm	mm	in	mm	in	kg	lb	
Manual												
TLT1000 HN	1000	-	-	-	-	50-160	2-6.3	1250	50	9.4	21	8451 1520 06
TLT1000 HW	1000	-	-	-	-	161-280	6.3-11	1250	50	10.7	23.6	8451 1520 63
TLT3000 HN	3000	-	-	-	-	74-180	2.9-7.1	2200	86.6	31.5	69.5	8451 1520 55
TLT3000 HW	3000	-	-	-	-	181-300	7.1-11.8	2200	86.6	34	75	8451 1520 89
Motor driven												
TLT1000 MN ^a	1000	14	45.9	4	85	50-160	2-6.3	1250	50	11	24	8451 1520 14
TLT1000 MW ^a	1000	14	45.9	4	85	161-280	6.3-11	1250	50	12.3	27.1	8451 1520 71
TLT3000 MN ^b	3000	17.8	58.4	42	89	74-180	2.9-7.1	2200	86.6	48	105.8	8451 1520 30
TLT3000 MW ^b	3000	17.8	58.4	42	89	181-300	7.1-11.8	2200	86.6	51.5	113.5	8451 1520 97
TLT5000 M ^b	5000	16.2	53.1	42	89	181-300	7.1-11.8	2500	98.4	74	163.2	8451 1520 48

^a Pendant control must be ordered separately.

^b Includes handle for control chain. Control chain must be ordered separately.

Performance figures are at 6 bar working pressure.

Motor-driven trolleys have 1/2" BSP air connection. 12.5 mm (1/2") hose size is recommended for TLT1000 MN/MW, 20 mm for TLT3000 MN/MW and TLT5000 M.

Dimensions

Model	A		B		C		D		E		F	
	mm	in	mm	in	mm	in	mm	in	mm	in	mm	in
Manual												
TLT1000 HN	26	1.1	52	2.0	212	8.3	-	-	264	10.4	-	-
TLT1000 HW	26	1.1	52	2.0	Beam width + 57	Beam width + 2.3	-	-	264	10.4	-	-
TLT3000 HN	35	1.4	78	3.1	262	10.3	-	-	384	15.2	-	-
TLT3000 HW	35	1.4	78	3.1	Beam width + 89	Beam width + 3.5	-	-	384	15.2	-	-
Motor driven												
TLT1000 MN	24	1.0	52	2.0	212	8.3	225	8.9	264	10.4	-	-
TLT1000 MW	24	1.0	52	2.0	Beam width + 57	Beam width + 2.3	225	8.9	264	10.4	-	-
TLT3000 MN	37	1.5	78	3.1	262	10.3	148	5.9	380	15.0	94	3.7
TLT3000 MW	37	1.5	78	3.1	Beam width + 89	Beam width + 3.5	148	5.9	380	15.0	94	3.7
TLT5000 M	41	1.6	93	3.7	Beam width + 97	Beam width + 3.8	166	6.6	437	17.2	59	2.4

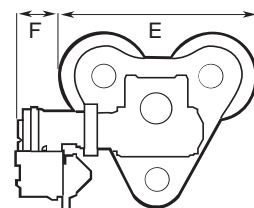
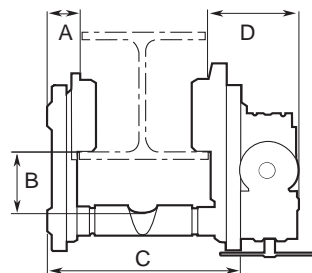

Accessories Included

For hoists

Wooden handle for pull chain
Hose nipple BSP 1/2"
Suspension hook and load hook

For trolleys

TLT 3000 MN/MW/ 5000 M
Wooden handle for pull chain

Optional Accessories

For air hoists

Designation	LLA250/500	LLA2500/5000 EX
	980/1000 EX	Ordering No.
Load chain, zinc plated, per m	4310 2293 00	4310 2296 00
Control chain, zinc plated, per m	4310 0748 00	4310 0748 00
2 button pendant control		
Handle and actuators only	4310 2261 90	4310 2262 90
Hose set per m	4310 2310 91	4310 2310 91
4 button pendant control		
Handle and actuators only	4310 2263 90	4310 2264 90
Hose set per m	4310 2310 96	4310 2310 95
Twist rod control		
Complete (1.1-2.0 m)	4310 0774 91	4310 0774 91
Extension set (1.1-1.9 m)	4310 0780 91	4310 0780 91
Articulating link	4310 0876 91	4310 0876 91
Chain collectors		
PVC for length of chain		
- 4 m	4310 0742 04	
- 7 m	4310 0742 07	4310 2291 07
-12 m	4310 0742 12	
-18 m	4310 0742 18	
-25 m	4310 0742 25	
Chain collectors		
Steel for length of chain		
-12 m		4310 2102 80
-18 m		4310 2109 80
Overload protection device		
LLA250 EX	4310 0812 83	
LLA500 EX	4310 0812 84	
LLA980 EX	4310 0812 85	
LLA1000 EX / 2500 EX / 5000 EX	incl as standard	incl as standard
Safety hooks, zinc plated	4310 0739 01	
Chain stop, zinc plated	4310 0740 91	4310 2097 91

NOTE: For items specified per metre, the required length should be indicated by multiplying the Ordering No. by the required length, ie. to order 12 m of chain for an LLA250 the order should be **12 x 4310 2293 00**.

When ordering load chain, follow the recommendations on chain given in the technical data for LLA hoists.

For trolleys

Designation	TLT1000M	TLT3000M	TLT5000M
	Ordering No.	Ordering No.	Ordering No.
Zinc plated control chain per m		4310 0748 00	4310 0748 00
2 button pendant control			
Handle and actuator only	4310 0835 92	4310 2262 91	4310 2262 91
Hose kit per m	4310 2310 97	4310 2310 98	4310 2310 98

Service



Contents	Page
Introduction.....	343
Service packages	344
Service packages for new equipment	346

It pays to let the original manufacturer service your tools

An Atlas Copco service program is designed to cut your production costs. The savings you can expect depend on how your production looks today – line assembly or fixed stations, tool types used, applications, frequency of tool use, work environment and other factors.

An Atlas Copco ToolScan or a ToolScan RCM on your tool population will give you the answers to these questions. By acting on the recommendations provided, many customers have reported savings in production costs of up to 60%.

A properly serviced tool will perform correctly for longer periods, it will also consume less energy and get the job done faster.

Use our Operating Cost Savings Calculator on your tools to identify potential savings.

Are you getting the most from your air tools?

- Would your tools work better with a Preventive Maintenance Program (PM)?
- Are the tools correctly adjusted for the application?
- Have you checked your air line for correct flow, air quality, leakages, etc.?
- Is your air line system correctly dimensioned?
- Are there areas with significant pressure drops?
- Do you know the status and number of tools in your production?
- What is the power efficiency (l/kWs) of your tools?
- Do you use the optimal tool for each application?



Would you like to reduce the operating costs for your electric tools?

- Have you calculated the total operating cost of your tools and the impact a Preventive Maintenance Program could have?
- Are you currently performing any preventive maintenance, or just repairs when tools break down?

With our ToolScan RCM process we can optimize a Preventive Maintenance Program for your type of production. This can provide cost savings of up to 60% and, in some cases, even more. Our RCM Operating Cost Savings Calculator helps you to identify your total potential savings.

How could your production be optimized?

- Is your operation really a zero-fault production?
- Could productivity be improved on your line?
- In new production projects is the focus on quality and efficiency?

Bolted joint issues arise in all types of assembly. While the tooling is often wrongly blamed, in most cases there are other factors affecting the bolted joint. In Production Optimization we take care of these issues, both in existing production and in new projects.

Your ideal Service Partner

At Atlas Copco, we continuously seek ways to improve our customers' operations, as well as our own. With this in mind, we are determined to be the world's most professional supplier of industrial service solutions for fixtured and hand-held power tools. To achieve that we have developed a range of standard service packages that will help our customers to improve their quality and productivity in production.

EFFECTIVE SERVICE PACKAGES

REPAIR

With today's high demands on minimizing downtime for our customers, we focus on specialized workshops that can handle quick repairs and complete overhauls in the most cost-efficient way. To do that we keep a large inventory of spare parts in stock, and we have upgraded with factory fixtures and test equipment to increase our efficiency. With all this, plus certified mechanics dedicated to specific tool models, we've minimized lead times and improved the quality of each repair. After service all tools are rigorously tested to Atlas Copco specifications.

Using the box system:

- Place the broken tool in the box.
- Sign up for direct repair according to the fixed price or a quote.
- The tool is repaired, tested and sent back to you with a full report.

TOOLSCAN™

Our ToolScan™ report informs you of the status of your air tools and air supply at each workstation. The service is carried out by a highly experienced certified technician and covers the following areas:

- AirScan of the air supply at each workstation.
- Status and performance check of the tools.
- Other services can be added.
- A report informing you of the status of your air supply and tools, including recommendations for improvements. You can then, together with your team, decide the next step without a binding agreement.



CALIBRATION

With our network of calibration laboratories we can offer a complete package of calibration services to help you control quality for all assembly tools and measurement equipment in your production.

An efficient way to control quality:

- Traceability and document management.
- Calibration/verification of transducerized tools and controllers.
- Torque adjustment and capability test.
- Verification test for a specific application.
- Accredited and factory calibration of measurement equipment.
- Testing and calibration of click and torque wrenches.
- Other special requests, such as angle calibration, etc.
- We remind you for your next calibration.



PREVENTIVE MAINTENANCE

Like other machines, Atlas Copco industrial power tools need regular maintenance in order to fulfill their full potential in terms of performance and reliability. Different agreements are available, tailored to your needs. We offer maintenance both on-site or off-site, or a combination. With our Operating Cost Calculator, you can calculate the potential savings a preventive maintenance program will provide for your specific operation.

FULL COVERAGE

A fixed budget for all tool maintenance. Our Full Coverage option keeps power tools in top operating condition and provides a fixed budget for all tool maintenance. Other services can be added. To develop the optimum service program for their specific manufacturing operation, customers can take advantage of our unique ToolScan RCM process. For your new tools, take a look at our ToolCover..

Full Coverage includes:

- Repair, including parts.
- Calibration.
- Preventive maintenance program.
- On-site/off-site options.
- Other services can be added.

TOOLSCAN RCM

RCM (Reliability Centered Maintenance) is a proven method of rationalizing and optimizing maintenance costs in manufacturing industries. With ToolScan RCM we balance maintenance against the operational cost of a failure. Based on our extensive tool failure statistics, we analyze your total operating costs, the tool applications and the probability of tool failure. With this information we create the optimum maintenance program for your specific production operation.

OUTSOURCING SOLUTIONS

We have extensive experience of outsourcing solutions and currently have more than 75 on-site workshops. These are examples of the areas we cover:

Focus on your core business:

- Preventive maintenance, repair and calibration of all brands and types of tools.
- Installation and start-up support.
- Service management system, including developing Key Performance Indicators.
- Line and process support.
- Back-up tool/equipment and spare parts management.
- Other customer requests.

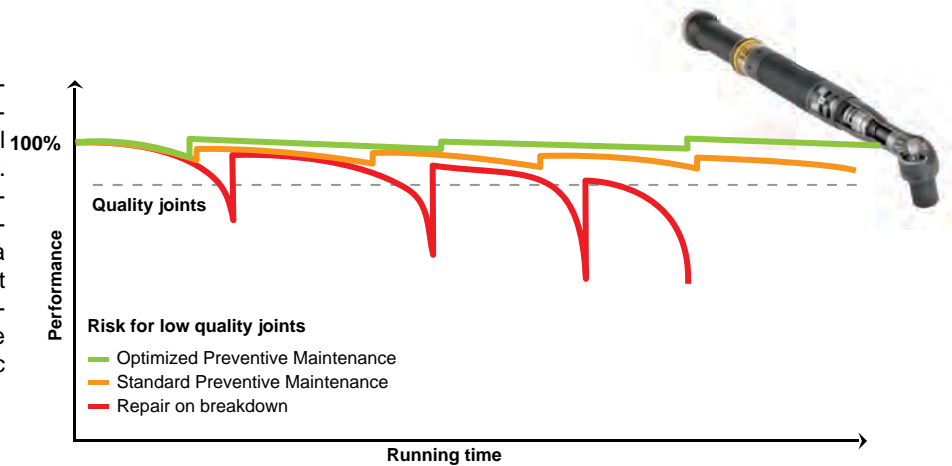

By keeping your assembly tool in the low risk area the chance of failures and torque scatter is minimized.

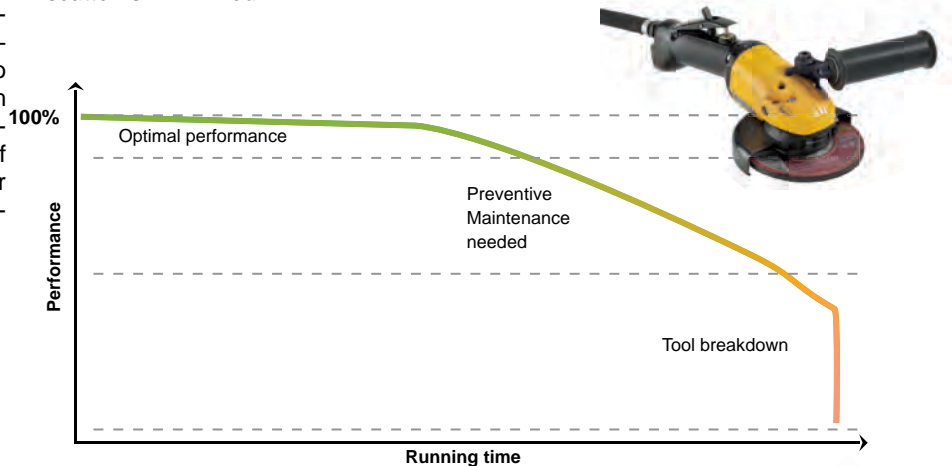

Correct lubrication of all gears is crucial for highly productive industrial tools. The most common cause of oil/grease leakage is worn seals.

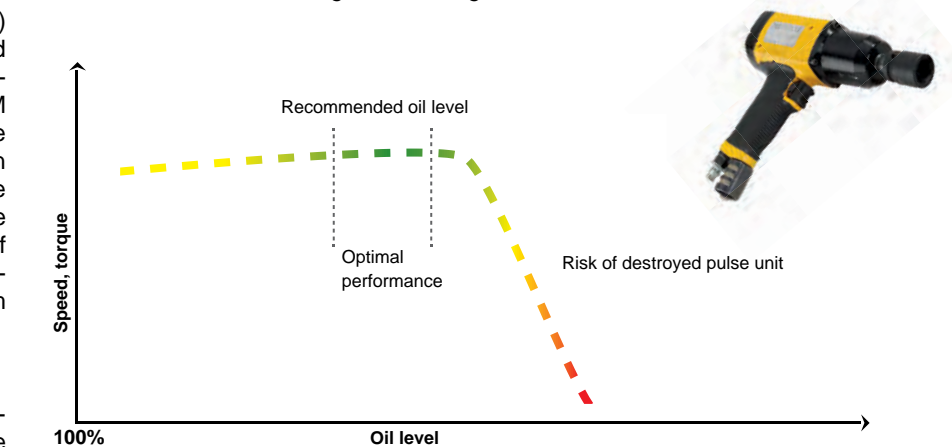

Oil level decrease in small steps during operation and could end up in a destroyed pulse unit. Most of our customer have to replace the tool because of that.

Some typical KPI indicators used:

- Turnaround time for repair.
- MTTR (Mean Time To Repair).
- MTBF (Mean Time Between Failures).
- Number of preventive maintenance actions vs. repair/failure development.
- Root cause analysis.
- Top 5 problem applications with actions.
- Availability of equipment.

Service packages for new equipment

Maximize your investment. Investing in new tools to upgrade an existing production line? Or perhaps you're designing, installing and commissioning an entirely new line. In either case Atlas Copco's specialists are there every step of the way to help you focus on quality and efficiency. With your production up and running our service programs will help keep you online with minimum interruptions.

INSTALLATION

Ensure trouble-free operation. A certified Atlas Copco technician ensure the highest quality installation and management of new tools and surrounding equipment. After each installation you receive an installation report that also suggests improvements in your production. With our fixed price installation and startup programs you always know the cost in advance.

PRODUCTION START-UP

Solve issues before going into full production. One of the most critical phases with your new equipment is start-up. Here we have the opportunity to solve issues in a way that will avoid problems during full production. Our certified technicians have long experience of starting up our equipment. With our expertise we make sure you get the best possible start for your full production.

CUSTOMER TRAINING

Helps raise productivity. Having well-trained operators, line engineers and quality people in your operation, means improved tool performance, higher productivity and correct use of your tools and equipment.

Our training also gives your personnel the capability to determine whether production issues and interruptions are the result of problems with the tools or with the parts used in assembly.

We have developed an extensive range of training courses that are supported from our larger Customer Centers throughout the world.

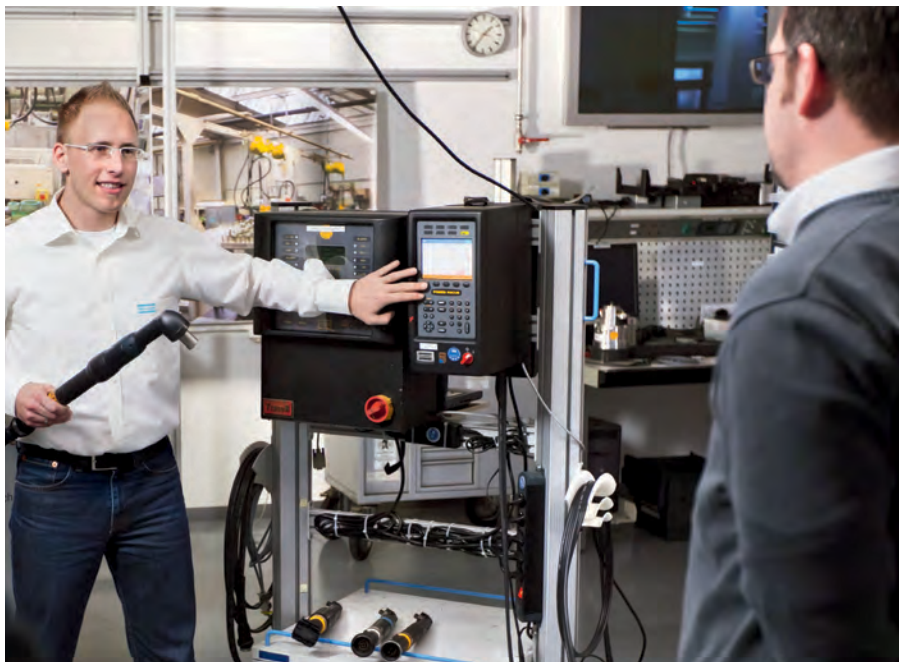

PRODUCTION OPTIMIZATION

Zero fault production at the lowest total cost. One of our core competences is production optimization. We help you to improve productivity in your existing assembly, or in your new production project. We ensure that the focus remains on quality and efficiency from concept/R&D through to full production. While bolted joint issues are the common denominator, there are many other factors involved.

Improve productivity on your existing line

Program optimization: Taking advantage of the functionality of our advanced controllers, our field engineers optimize monitoring and control limits to identify faulty joints.

Friction analysis: When quality issues like broken or elongated bolt are identified, the cause can be frictional changes in the bolted joint. A laboratory analysis can highlight the root cause enabling a solution to be found.

Joint analysis: If the problem is more complex, a full joint analysis might be necessary. Atlas Copco has the laboratory equipment, expertise and software to evaluate the development of clamp load in bolted joints, as well as optimized rundown specifications.

Production optimization: Analysis of the entire workstation from the perspective of the bolted joint is Atlas Copco's unique method of optimizing production. It can help raise product quality and achieve cost-effective production.

Focus on quality and efficiency in new projects

Concept R&D: Actions include – Bolted joint review, clamp load and friction analysis, tool accessibility and rundown specification analysis.

Strategy development: Actions include – Bolted joint analysis, SW simulation, joint classification, tool selection, fastening process and error-proofing development.

Pilot test: Actions include – Bolted joint analysis, implementation of customized fastening processes and sequences, clamp load, frictional and quality validation.

Pre production: Actions include – Bolted joint analysis, evaluating process limits, joint analysis, optimizing sequencing, cycle time, bolt relaxation and product quality.

Full production: Actions include – Bolted joint analysis, determination of Cp/Cpk, quality status, overview of assembly potentials, quality system potentials and ergonomic improvement.



SERVICE PROGRAMS – FULL COVERAGE PROGRAMS AND ON-SITE TECHNICIAN

Depending on the size of your operation, different service programs are available for your new Atlas Copco equipment. Atlas Copco ToolCover and Express-Cover programs ensure trouble-free operation for your electric tools. If you have a new plant or larger new production line, an on-site Atlas Copco technician is a recommended option. We have long experience of handling new tool and installation issues in an efficient way.

TOOLCOVER

- Full coverage option for two or three years.
- Cover both repairs and parts.
- Preventive Maintenance program tailored to your production rate.
- Yearly calibration with protocol.
- Inspection protocol checking critical points on tools/system.
- Off-site / On-site options.



Vibration and Noise Emission Values

The values you will find in this table are the official declared values both for vibration and noise. On December 29, 2009 the Machinery Directive, 2006/42/EC repealed the old directive 98/37/EC. From that date the 3-axes vibration total values are the official values. Our tools are measured according to the relevant part in the ISO 28927 series. For machines where no specific test code exists the ISO 20643 is used. In such cases the test procedure must be described in detail in connection to the given values

Measuring vibrations

Our declared vibration values are expressed as vibration total value and a vibration total value is the vector sum of the weighted vibration in three directions.

On machines intended to be used with two hands, two positions are measured and the position with the highest value is declared.

Measuring vibrations

Our declared noise emission information is derived according to the standard EN ISO 15744. The A-weighted emission sound pressure level is measured in a semi-anechoic room at 5 points around the tool. The declared sound pressure level for the tool is the average sound pressure level from the 5 microphones. If the declared sound pressure level exceeds 80 dB(A), the A-weighted sound power level is declared in addition to the sound pressure level.

Because each tool can be used in many different applications, it is impossible to predict what the process sound pressure level will be, therefore EN ISO 15744 specifies that most types of tools are run under no load conditions with the supplied accessories mounted.

Suitable for comparison purposes only

The declared values given in this table were obtained by laboratory type testing in accordance with the stated standards and are suitable for comparison with the declared values of other tools tested in accordance with the same standards.

These declared values are not adequate for use in risk assessments and values measured in individual work places may be higher. The actual exposure values and risk of harm experienced by an individual user are unique and depend upon the way the user works, the workpiece and the workstation design, as well as upon the exposure time and the physical condition of the user.



Atlas Copco has a well equipped laboratory for measuring tool noise and vibration emissions. It contains advanced vibration measurement tools, a state-of-the-art acoustics laboratory and dedicated computer software for analysing measurement and test results.

Atlas Copco Industrial Technique AB, cannot be held liable for the consequences of using the declared values, instead of values reflecting the actual exposure, in an individual risk assessment in a work place situation over which we have no control.

Managing exposure to noise and vibration

Power Tools may cause hand-arm vibration syndrome if the use is not adequately managed. An EU guide to managing hand-arm vibration can be found at www.humanvibration.com/EU/VIBGUIDE.htm

We recommend a programme of health surveillance to detect early symptoms which may relate to noise or vibration exposure, so that management procedures can be modified to help prevent future impairment.

Vibration and Noise Emission Values

Assembly tools

Model	Vibration total value (3 axes value) according to ISO 28927-2 Valid from 2010		Sound pressure levels and sound power levels ^a according to ISO 15744		Model	Vibration total value (3 axes value) according to ISO 28927-2 Valid from 2010		Sound pressure levels and sound power levels ^a according to ISO 15744	
	Value 3-axes m/s ²	Uncertainty m/s ²	Sound pressure dB(A)	Sound power dB(A)		Value 3-axes m/s ²	Uncertainty m/s ²	Sound pressure dB(A)	Sound power dB(A)
Pneumatic screwdrivers					Impact Wrenches				
Pistol grip					Pistol grip				
Shut-off					Non shut-off				
LUM22 HR	<2.5	-	78	-	LMS08 HR	<2.5	-	85	96
LUM32 HR	<2.5	-	77	-	LMS18 HR	5.3	-	90	101
LUM12 HRX	<2.5	-	74	-	LMS28 HR	5.2	-	92	103
LUM22 HRX	<2.5	-	78	-	LMS38 HR	3.5	1.5	88	99
LUM10 HRX	<2.5	-	72	-	LMS48 HR	5.0	1.4	89	100
LUM12 HRF	<2.5	-	<70	-	LMS58 HR	5.5	1.6	92	103
Straight					Straight				
Shut-off					Non shut-off				
LUM02 PR	<2.5	-	<70	-	LMS08 SR	5.6	-	85	96
LUM10 PR	<2.5	-	<70	-	LMS68 GIR/GOR	8.1	2.8	98	109
LUM12 PR	<2.5	-	75	-	LMS88 GIR/GOR	4.8	2	100	111
LUM22 PR	<2.5	-	75	-	Hydraulic impulse nutrunners				
LUM12 SR	<2.5	-	75	-	Pistol grip				
LUM22 SR	<2.5	-	78	-	Shut-off				
Angle					EP3PTX5 HR42				
Shut-off					EP4PTX9 HR42				
LTV009	<2.5	-	75	-	EP4PTX9 HR10	<2.5	-	<70	-
LTV18	<2.5	-	71	-	EP5PTX17 HR42	<2.5	-	74	-
Pistol grip					EP5PTX19 HR10				
Direct drive					EP6PTX28 HR42				
LUD12 HRX	<2.5	-	74	-	EP6PTX32 HR10	3	1	77	-
LUD22 HR	<2.5	-	76	-	EP7PTX55 HR10	<2.5	-	75	-
LUF34 HRD	<2.5	-	79	-	EP8PTX70 HR10	4.2	0.8	79	-
COMBI22	<2.5	-	76	-	EP9PTX80 HR13	3.5	1	80	-
COMBI34	<2.5	-	79	-	EP11PTX120 HR13	5.6	0.8	82	93
Slip clutch^b					EP13PTX150 HR13				
Pistol grip					EP15PTX250 HR20				
TWIST12 HRF	<2.5	-	80	-	EP19PTX450 HR20	6.5	0.4	88	99
TWIST12 HRX	<2.5	-	80	-	EP5PTS12 HR42	8.2	1	88	99
TWIST22 HR	<2.5	-	86	97	EP5PTS14 HR10	4.3	0.7	75	-
TWIST22 HRX	<2.5	-	86	97	EP6PTS20 HR42	2.8	0.8	73	-
TWIST HRF	<2.5	-	80	-	EP6PTS22 HR10	3.4	0.5	76	-
LUF34 HR	<2.5	-	81	92	EP7PTS30 HR42	2.9	0.7	77	-
Straight					EP7PTS35 HR10				
TWIST12 SR3	<2.5	-	85	96	EP8PTS40 HR42	5.9	0.9	78	-
TWIST12 SR4	<2.5	-	85	96	EP8PTS55 HR10	4.3	0.8	76	-
TWIST22 PR	<2.5	-	86	97	EP10PTS90 HR13	5.7	0.7	79	-
TWIST22 SR6	<2.5	-	86	97	EP12PTS150 HR13	4.6	1.5	76	-
TWIST22 SR10	<2.5	-	86	97	EP14PTS250 HR20	4.8	0.9	80	-
Angle					EP18PTS410 HR20				
TWIST VR07	<2.5	-	81	92	EP7PTS35 HRF10	4.7	0.6	82	93
TWIST VR13	<2.5	-	82	93	EP8PTS55 HRF10	6.3	1	85	96
					EP10PTS90 HRF13				
					4.3 0.8 76 -				
					4.6 1.5 76 -				
					4.8 0.9 80 -				

^a The uncertainty in the sound levels is 3 dB(A).

^b 1-axis value measured with clutch slipping.

Continued...

Vibration and Noise Emission Values

Material removal tools

Model	Vibration total value (3 axes value) according to ISO 28927-10 Valid from 2010		Sound pressure levels and sound power levels ^a according to ISO 15744		Model	Vibration total value (3 axes value) according to ISO 28927-5 Valid from 2010		Sound pressure levels and sound power levels ^a according to ISO 15744	
	Value 3-axes m/s ²	Uncertainty m/s ²	Sound pressure dB(A)	Sound power dB(A)		Value 3-axes m/s ²	Uncertainty m/s ²	Sound pressure dB(A)	Sound power dB(A)
Percussive					Drills				
Riveting hammers					Pistol grip				
Vibration damped					LBB16 EP				
RRH04P	<2.5	-	93	104	LBB16 EPX				
RRH06P	3.9	1.4	91	102	LBB26 EPX				
RRH08P	4.8	1.6	92	103	LBB36				
RRH10P	5.1	1.7	91	102	LBB37				
RRH12P	4.4	1.1	93	104	LBB45 H017				
RRH14P	5.4	2.9	93	104	LBB45 H006				
Conventional type					LBB45 H004				
RRN11P	4	1.6	98	109	Straight				
					LBB16 S260				
					LBB16 S064				
					LBB16 S045				
					LBB16 S038				
					LBB16 S029				
					LBB16 S022				
					LBB16 S012				
					Angle				
					LBV16M 005				
					LBV16M 010				
					LBV16M 018				
					LBV16M 032				
					LBV16M 045				
					LBV16M 055				
					LBV11 30°				
					LBV16 30°				
					LBV36 30°				
					LBV16 45°				
					LBV11 90°				
					LBV16 90°				
					LBV36 90°				
					LBV16 Z				
					LBV16 90° Large				
					LBV36 90° Large				
					LBV37 90° Heavy duty				
					LBV16 018-11 Key chuck model				
					LBV34 S Key chuck model				
					Micro stop drills				
					LBS36				
					Positive Feed drills				
					PFD1500RA				

^a The uncertainty in the sound levels is 3 dB(A).

^b Tools for fixtured applications have no vibration values.

The tool key below explains the significance of the letters/numbers forming the name of the tool model.

Impact wrenches

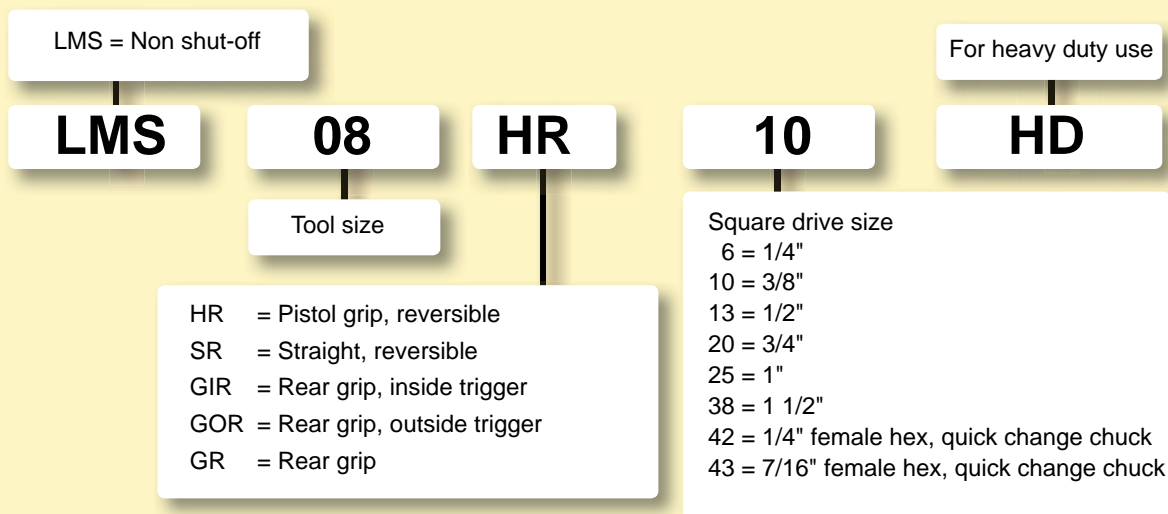

Hydraulic impulse nutrunners

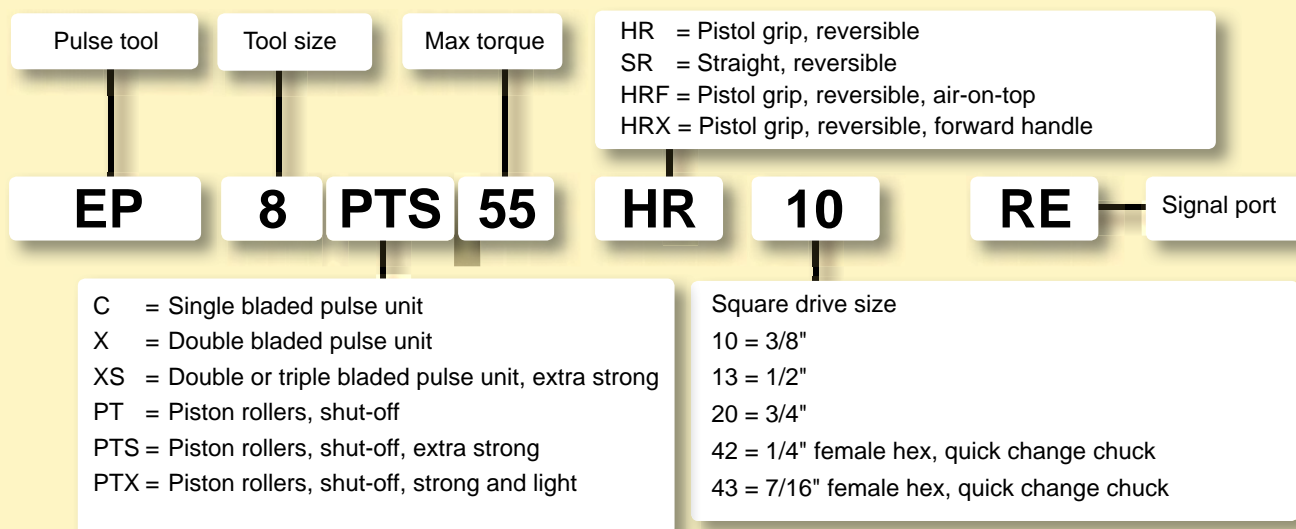

Monitoring impulse nutrunners

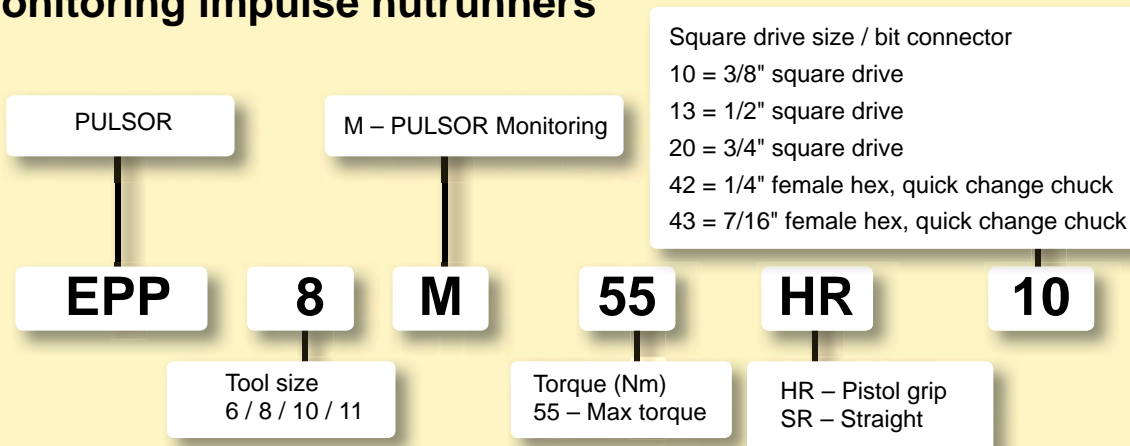

Pneumatic screwdrivers

Torque control
 LUM = Shut-off clutch
 TWIST/LUF = Slip clutch
 LUD/COMBI = Direct drive
 LTV = Shut-off angle tool

HRF = 3-way air inlet with balanced grip
 HRX = Balanced pistol grip
 HR = Pistol grip
 PR = Straight tool with push start
 SR = Straight tool with lever start
 R = Reversible angle tool

P = Push start
 RE = Reporting signal
 Special rpm models
 42 = 1/4" female hex, quick change chuck
 10 = 3/8" female hex
 6 = 1/4" male hex
 Q = 1/4" quick change chuck

LUM 22 HRX

6 -P

Tool size
 12 – LUM, TWIST, LUD
 22 – LUM, TWIST, LUD
 009 – LTV

Torque (Nm)

Pneumatic nutrunners

L = Pneumatic

Motor size

R, SR = Reversible
 N, S = Non reversible
 HR = Reversible (pistol grip)
 H = Non reversible (pistol grip)

T = Shut-off
 B, M = Stall

Generation

L T V 2 8 X R 29 10 Options

V = Right angle
 D = In-line
 P = Pistol grip
 C = Crowfoot
 O = Tube nut
 R = Ratchet
 K = Worm-drive

X = High speed option

Speed
 001 = 100 rpm
 002 = 200 rpm
 etc.
 or
 Torque
 10 = 10 Nm
 15 = 15 Nm
 etc.

RE = Signal port
 FS = Flush socket
 HAD = Hold-and-drive
 TS = Built-in transducer/signal lights etc.
 AS = Angle encoder/signal lights

Square drive size

6 = 1/4"
 8 = 5/8"
 10 = 3/8"
 12, 13 = 1/2"
 19, 20 = 3/4"
 25 = 1"
 38 = 1 1/2"
 42 = 1/4" female hex
 Q = 1/4" quick chuck

The tool key below explains the significance of the letters/numbers forming the name of the tool model.

Battery screwdriver – BCP

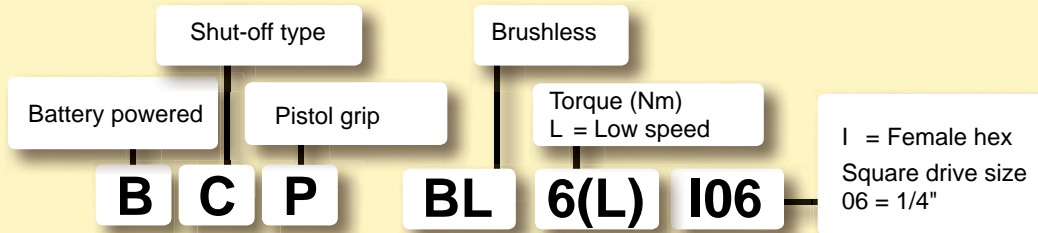

Electric screwdriver – EBL



Electric screwdriver – MicroTorque

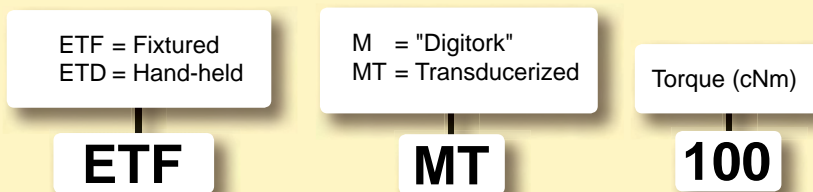

Electric screwdriver – Tensor DL

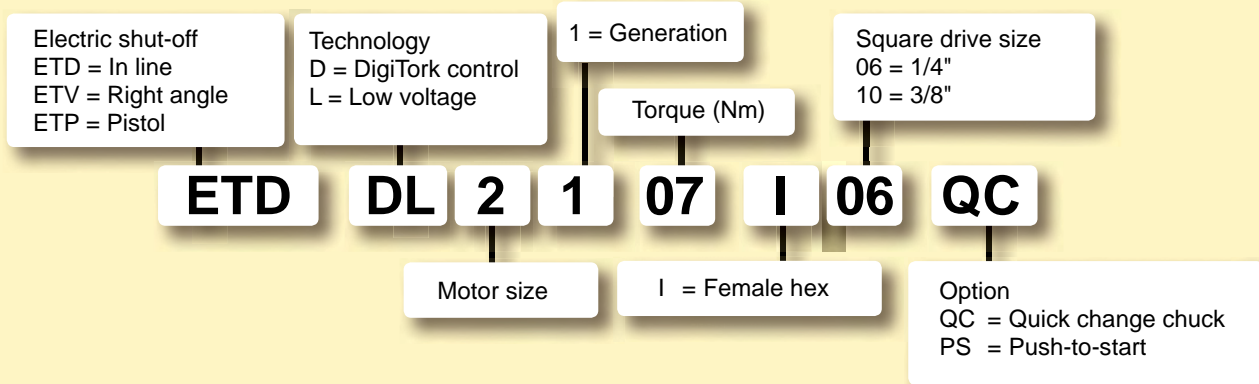

Electric nutrunner – Tensor DS

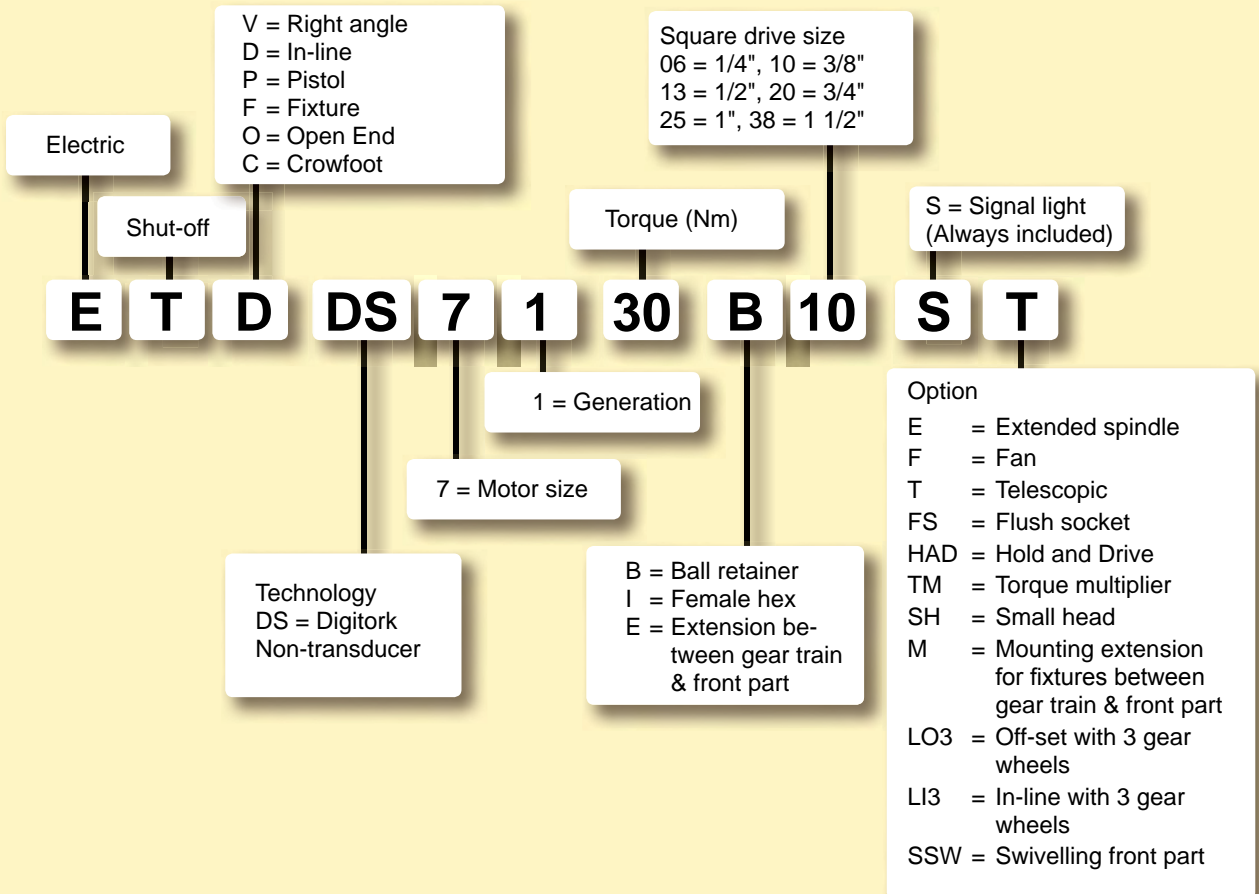

Electric nutrunner – Tensor ST/SL

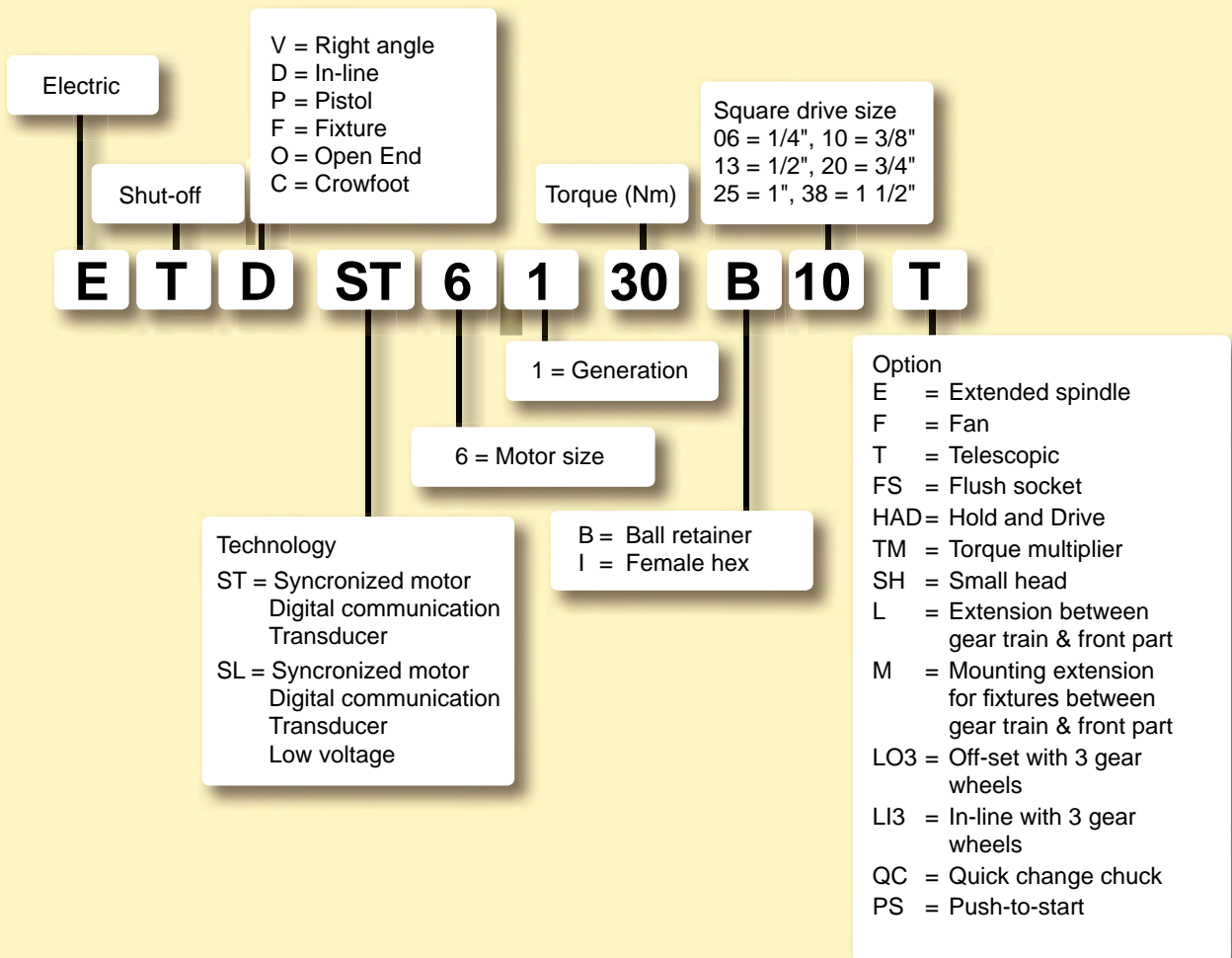

Power Focus

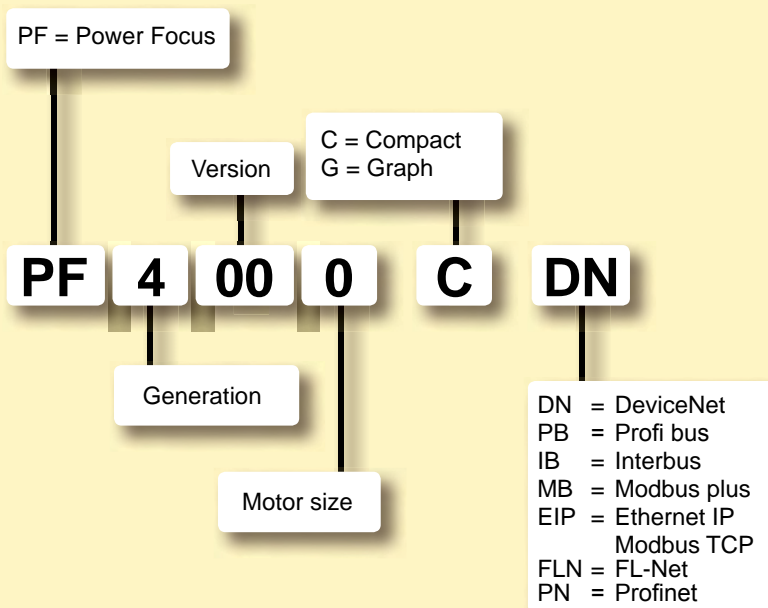

Fixtured nutrunner – QST

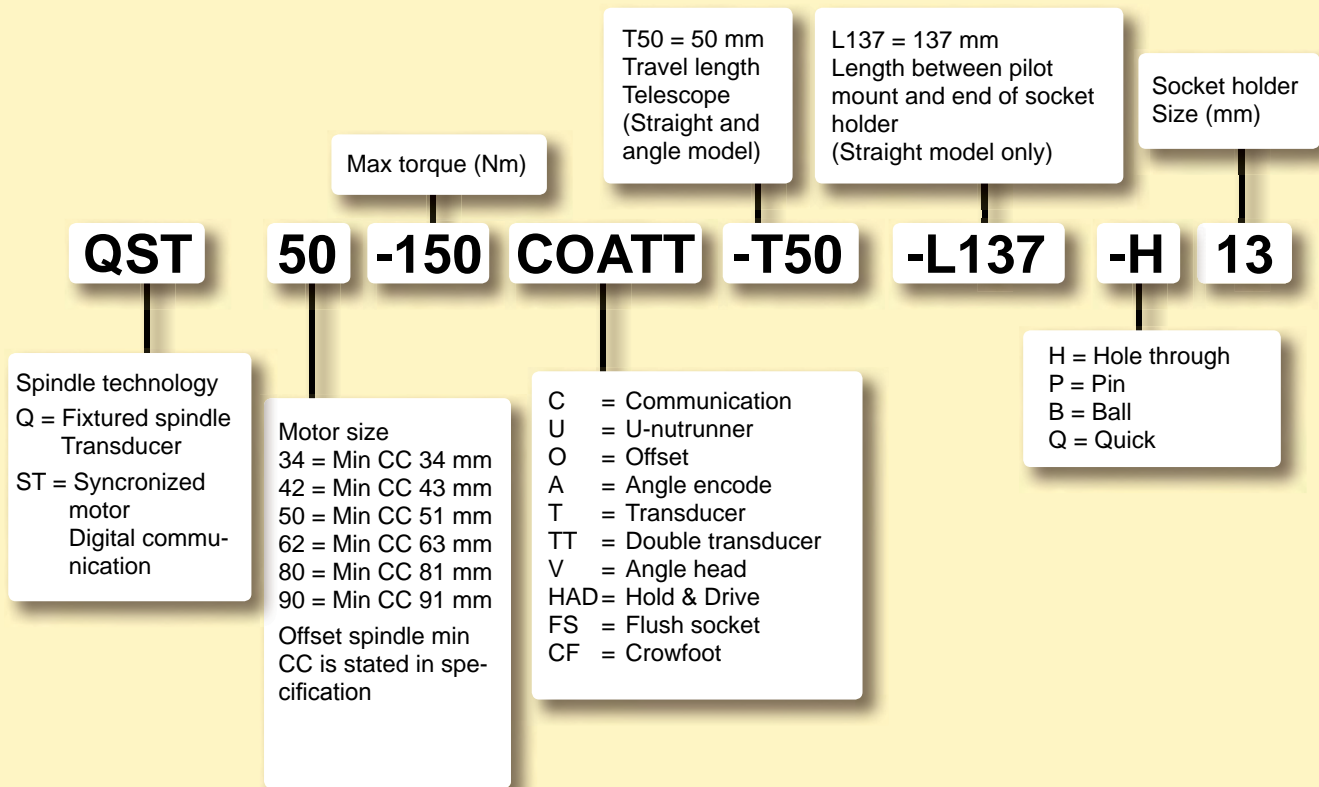

Power MACS 4000

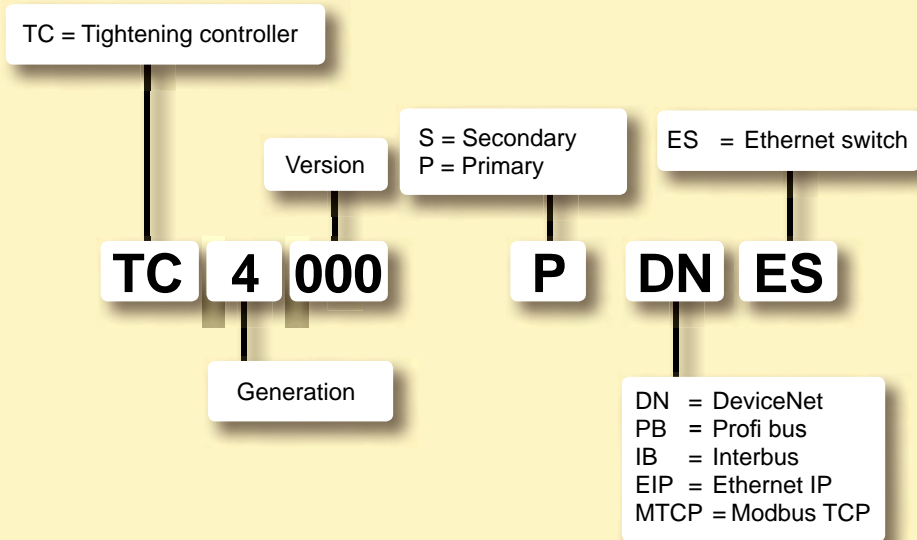

Tool Designations

BAL – Ball valve	LBV – Angle drill
BCP BL – Battery screwdriver, pistol grip, clutch type	LBV M – Modular drills
BLOCK – Blow protector	LCS – Circular cutters
BVC – Battery nutrunner, angle model, clutch type	LGB – Tapper
CABLAIR – CABLAIR hose	LLA – Air hoist
CLAW – Claw coupling	LLT – Trolley
COL – Colibri balancer	LMD – Pneumatic nutrunner, stall type, straight model
COMBI – Pneumatic screwdriver, direct drive	LMK – Pneumatic nutrunner, stall type, worm drive
COMBI – Pistol grip drill	LMP – Pneumatic nutrunner, stall type, pistol grip
DIM – Air preparation unit, lubricator	LMS – Impact wrenches, non shut-off type
DOS – Direct lubricator unit	LMV – Pneumatic nutrunner, stall type, angle model
EBL – Electric screwdriver, brushless clutch type	LSF – Die grinder
EP C/X/XS – Hydraulic impulse nutrunner, non shut-off, ERGOPULSE	LSK – Routers
EP PT/PTS/PTX – Hydraulic impulse nutrunner, shut-off, ERGOPULSE	LSO – Orbital sander
EPP – Monitoring impulse nutrunner, PULSOR C	LSR – Straight grinder
ErgoGUN – Blow gun	LSS – Vertical grinder and sander
ErgoNIP – Nipple	LST – Random orbital sander
ErgoQIC – Quick coupling	LSV – Angle grinder and sander
ETC DS – Electric nutrunner, shut-off type, crowfoot, TENSOR DS	LTC – Pneumatic nutrunner, shut-off type, crowfoot
ETC ST – Electric nutrunner, shut-off type, crowfoot, TENSOR ST	LTD – Pneumatic nutrunner, shut-off type, straight model
ETC STB – Battery nutrunner, crowfoot, TENSOR STB	LTO – Pneumatic nutrunner, shut-off type, tube nut
ETD DL – Electric screwdriver, shut-off type, straight model, TENSOR DL	LTP – Pneumatic nutrunner, shut-off type, pistol grip
ETD DS – Electric nutrunner, shut-off type, straight model, TENSOR DS	LTV – Pneumatic nutrunner/screwdriver, shut-off angle model
ETD ES – Electric nutrunner, shut-off type, straight model, TENSOR ES	LUD – Pneumatic screwdriver, direct drive
ETD M – Electric screwdriver, hand-held "Digitork", MicroTorque	LUF – Pneumatic screwdriver, slip-clutch
ETD S – Electric nutrunner, shut-off type, straight model, TENSOR S	LUM – Pneumatic screwdriver, shut-off clutch
ETD SL – Electric screwdriver, straight model, TENSOR SL	LZB – Small vane air motor
ETD ST – Electric nutrunner, shut-off type, straight model, TENSOR ST	LZL – Vane air motor
ETD STR – Electric screwdriver, straight model, TENSOR STR	MRTT-B – Screwdriver for low torque applications
ETF DL – Electric screwdriver, shut-off type, fixture, TENSOR DL	MT TH – Torque In/Line rotary transducer
ETF M – Electric screwdriver, fixtured "Digitork", MicroTorque	MT TR – Torque&Angle In/Line rotary transducer
ETF MT – Electric screwdriver, fixtured transducerized, MicroTorque	MT TRA – Stationary torque transducer
ETF SL – Electric screwdriver, shut-off type, fixture, TENSOR SL	MT TS – Manual screwdriver torque transducer
ETO DS – Electric nutrunner, shut-off type, open end, TENSOR DS	MultiFlex – Swivel connectors
ETO ST – Electric nutrunner, shut-off type, open end, TENSOR ST	NIP – Nipple
ETO STB – Battery nutrunner, tube nut, TENSOR STB	Optimizer – Air tool oil
ETP DL – Electric screwdriver, shut-off type, pistol grip, TENSOR DL	PFD – Power feed drills
ETP DS – Electric nutrunner, shut-off type, pistol grip, TENSOR DS	POLUR – Polyurethane hose
ETP S – Electric nutrunner, shut-off type, pistol grip, TENSOR S	PVC – PVC hose
ETP SB – Battery nutrunner, pistol grip TENSOR SB	QIC – Quick coupling
ETP SL – Electric screwdriver, shut-off type, pistol grip, TENSOR SL	QRTT – Transducer for spindle and fixtured tool calibration
ETP STB – Battery nutrunner, pistol grip TENSOR STB	QST – Fixtured electric nutrunner, shut-off type
ETP ST – Electric nutrunner, shut-off type, pistol grip, TENSOR ST	RAB – Screw-feed drill
ETP STR – Electric screwdriver, pistol grip, TENSOR STR	RAM – Rammer
ETV DL – Electric screwdriver, shut-off type, angle model, TENSOR DL	RBB – Bucking bar, vibration damped
ETV DS – Electric nutrunner, shut-off type, angle model, TENSOR DS	REG – Air preparation unit, regulator
ETD ES – Electric nutrunner, shut-off type, angle model, TENSOR ES	RIL – Balancer
ETV S – Electric nutrunner, shut-off type, angle model, TENSOR S	RRC – Chipping hammer, conventional type
ETV SB – Battery nutrunner, angle model, TENSOR SB	RRD – Chipping hammer, vibration damped
ETV SL – Electric screwdriver, angle model, TENSOR SL	RRF – Chipping hammer, vibration damped
ETV ST – Electric nutrunner, shut-off type, angle model, TENSOR ST	RRH – Riveting hammers, vibration damped
ETV STR – Electric screwdriver, angle model, TENSOR STR	RRN – Riveting hammer, conventional type
ETV STB – Battery nutrunner, angle model, TENSOR STB	RUBAIR – Rubber hose
ETX – Fixtured electric nutrunner, shut-off type	RVM – Scaler, vibration damped
FIL – Air preparation unit, filter	SM – Torque arm, parallel
GHP – Torque arm, MicroTorque	SMC – Carbon arm
GTG – Turbo grinder	SML – Torque arm, linear
GTR – Straight turbo grinder	SPI – Spiral hose
GUN – Blow gun	SMS – Torque arm, linear
HM – Hose reel	SRTT-B – Static reaction torque transducer
HRIL – Hose reel	SRTT-L – Transducer for STAnalyser
HT – Torque testers	STB – Static Transducer Bench
IRTT-B – In-line rotary torque and torque/angle transducer	TLT – Trolley
JSB – Joint Simulator Bench	TPS – Tool Positioning System
LBB – Pistol grip and straight drill	TT – Torque testers
LBL – Automatic drilling and tapping unit	TURBO – Rubber hose
LBR – Pneumatic nutrunner, stall type, ratchet wrenches	TWIST – Pneumatic screwdriver, slip-clutch
LBS – Micro stop drill	WP – Balancer

